

Down Light

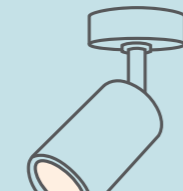

Spotlights

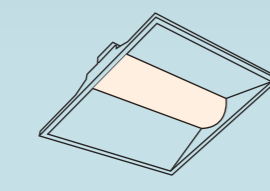

Panels and Troffers light

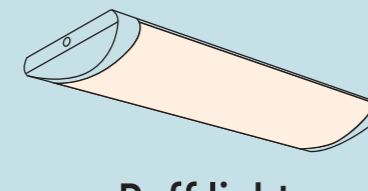

Puff light

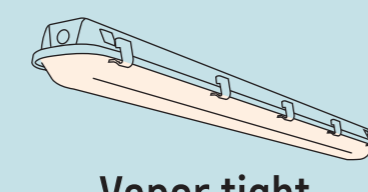

Vapor tight

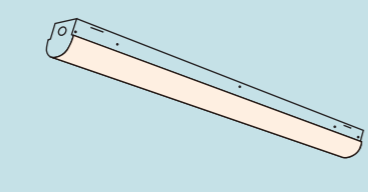

Linear Strip light

**Built-in Drivers**



PUP



CUP

Dimming manner	Output Power	Item No.	Input Voltage(VAC)	Output Current Channel	Output Voltage (VDC)	Size(L*W*H) (mm)
Dimming	DALI	PUP10D-1WMC-350	120-277	120/150/180/210/280/320/350mA*1	9-42	75*35*26.5
		PUP10D-1WMC-700	120-277	350/400/450/500/550/600/650/700mA*1	2-21	75*35*26.5
		PUP20D-1WMC	120-277	350/400/450/500/550/600/650/700mA*1	9-45	88*43*26.5
		PUP40D-1WMC-850	120-277	500/550/600/650/700/750/800/850mA*1	9-48	127*44*26.5
		PUP40D-1WMC-1200	120-277	850/900/950/1000/1050/1100/1150/1200mA*1	9-42	127*44*26.5
		PUP10A-1WMC-350	120-277	120/150/180/210/280/320/350mA*1	9-42	75*35*26.5
	0-10V	PUP10A-1WMC-700	120-277	350/400/450/500/550/600/650/700mA*1	2-21	75*35*26.5
		PUP20A-1WMC	120-277	350/400/450/500/550/600/650/700mA*1	9-45	88*43*26.5
		PUP40A-1WMC-850	120-277	500/550/600/650/700/750/800/850mA*1	9-48	127*44*26.5
		PUP40A-1WMC-1200	120-277	850/900/950/1000/1050/1100/1150/1200mA*1	9-42	127*44*26.5
		PUP10T-ILMC-350	120-277	120/150/180/210/280/320/350mA*1	9-42	75*35*26.5
		PUP10T-ILMC-700	120-277	350/400/450/500/550/600/650/700mA*1	2-21	75*35*26.5
Triac, ELV	PUP20T-ILMC	120-277	350/400/450/500/550/600/650/700mA*1	9-45	88*43*26.5	
	PUP40T-ILMC-850	120-277	500/550/600/650/700/750/800/850mA*1	9-48	127*44*26.5	
	PUP40T-ILMC-1200	120-277	850/900/950/1000/1050/1100/1150/1200mA*1	9-42	127*44*26.5	
	PUP17AT-1WMC	120-277	250/300/350/400mA*1	30-42	87*48*29	
	CUP25AT-1WMC	120-277	450/500/550/600mA*1	30-42	87*48*29	
	CUP34AT-1WMC	120-277	650/700/750/800mA*1	30-42	87*48*29	
Dimming	0-10V	CUP40AT-1WMC	120-277	850/900/950/1000mA*1	30-42	87*48*29
		HUP50AD-1W250C-MB	120-277	250mA*1	10-20	89*33*28
		HUP20AD-1WMC-400-NC	120-277	400mA*1	30-50	154*33*28
		HUP20AD-1WMC-800-NC	120-347	400mA*1	30-50	154*33*28
		HUP20AD-1WMC-400-NC	120-277	400mA*1	30-50	154*33*28
		HUP40AD-1WMC-800-NC	120-277	800mA*1	30-50	154*33*28
		HUP20A1-1WMC-400-NC	120-277	400mA*1	30-50	154*33*28
		HUP30A1-1WMC-600-NC	120-277	600mA*1	30-50	154*33*28
		HUP30A1-1WMC-800-NC	120-347	600mA*1	30-50	154*33*28
		HUP40A1-1WMC-800-NC	120-277	800mA*1	30-50	154*33*28
		HUP30A2-1WMC-600-RB	120-277	600mA*1	30-50	154*33*28
		HUP40A2-1WMC-800-RB	120-277	800mA*1	30-50	154*33*28
		HUP50A2-1WMC-1000-RB	120-277	1000mA*1	30-50	154*33*28
		HUP40AD-1WMC-800-6C	120-277	800mA*1	30-50	155*45*28
		HUP40AD-1WMC-800-6C	120-277	800mA*1	30-50	155*45*28
		HUP50AD-1WMC-1000-6C	120-277	1000mA*1	30-50	155*45*28
		HUP60AD-1WMC-1200-6C	120-277	1200mA*1	30-50	155*45*28
		HUP40A1-1WMC-800-6C	120-277	800mA*1	30-50	155*45*28
	HUP50A1-1WMC-1000-6C	120-277	1000mA*1	30-50	155*45*28	
	HUP60A1-1WMC-1200-6C	120-277	1200mA*1	34-40	155*45*28	
	HUP40A2-1WMC-800-6C	120-277	400/600/800mA*1	30-50	155*45*28	
	HUP50A2-1WMC-1000-6C	120-277	800/1000/1200mA*1	30-50	155*45*28	
	HUP60A2-1WMC-1200-6C	120-277	800/1000/1200mA*1	35-50	155*45*28	
	HUP40A2-1WMC-800-6C2	120-277	400/600/800mA*2	30-50	155*45*28	
	HUP50A2-1WMC-1000-6C2	120-277	600/800/1000mA*2	30-50	155*45*28	
	HUP60A2-1WMC-1200-6C2	120-277	800/800/1000mA*2	30-50	155*45*28	

Panels and Troffers light

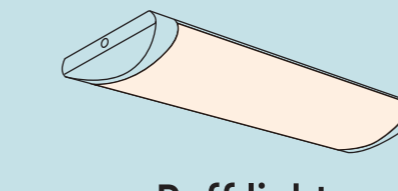

Puff light

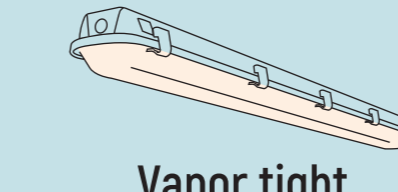

Vapor tight

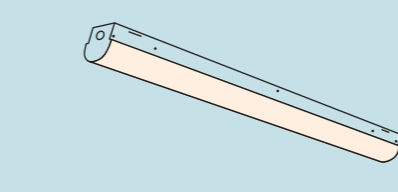

Linear Strip light

**Built-in Drivers**



HUP



EULP



LUP

HUP constant current dimming driver selection table

Size	MB [3.42"x1.57"x0.9"] (89*40*22.8mm)	R [6"x1.3"x1.1"] (155*33*28mm)	P [P3] [6"x1.8"x1.1"] (155*45*28mm)	M [9.5"x1.3"x1.1"] (241*33.5*28mm)	S [9.5"x1.7"x1.2"] (241*43*30mm)	L [16.8"x1.66"x1.2"] (426*42*30mm)
Range of Output Power	4W-23W	10W-50W	18W-60W	60W-80W	80W-90W	2Channel Output 60W-96W
Range of Output Current	150-700mA	300-1400mA	300-1800mA	400-2100mA	500-3000mA	11-2.75A
Range of Output Voltage	24-48V	24-50V	24-50V	24-50V	24-50V	24-50V
120-277VAC 0-10V Basic model	√	√	√	√	√	√
120-247VAC		√	√	√	√	
12V Auxiliary Power		√	√	√	√	
Power Adjustable		√	√	√	√	
CCT	√ (+Current Distributor)	√ (-Current Distributor)	√	√	√	

Dimming manner	Output Power	Item No.	Input Voltage(VAC)	Output Current Channel	Output Voltage (VDC)	Size(L*W*H) (mm)
Dimming	0-10V	HUP60A2-1WMC-1200-6C2	120-277	800/1000/1200mA*2	28-47	155*45*28
		HUP60A2-1WMC-1200-6C2	120-347	800/1000/1200mA*1	35-50	155*45*28
		HUP40A3-1WMC-800-6C	120-277	400/600/800mA*1	24-40	155*45*28
		HUP50A3-1WMC-1000-6C	120-277	600/800/1000mA*1	28-47	155*45*28
		HUP60A3-1WMC-1200-6C	120-277	800/1000/1200mA*1	26-40	155*45*28
		HUP80A0-1WMC-1700-M	120-277	1700mA*1	30-47	241*33.5*28
		HUP80A0-1WMC-2000-M	120-277	2000mA*1	26-40	241*33.5*28
		HUP80A1-1WMC-1700-M	120-277	1700mA*1	30-47	241*33.5*28
		HUP80A1-1WMC-2000-M	120-277	2000mA*1	26-40	241*33.5*28
		HUP80A2-1WMC-1700-M	120-277	1300/1500/1700mA*1	30-47	241*33.5*28
		HUP80A2-1WMC-2000-M	120-277	1600/1800/2000mA*1	26-40	241*33.5*28
		HUP80A3-1WMC-2000-M	120-347	1600/1800/2000mA*1	26-40	241*33.5*28
		HUP80A3-1WMC-1700-M	120-277	1300/1500/1700mA*1	30-47	241*33.5*28
		HUP80A3-1WMC-2000-M	120-277	1600/1800/2000mA*1	26-40	241*33.5*28
		HUP96A0-1WMC-2000-S	120-277	2000mA*1	30-48	241*43*30
		HUP96A0-1WMC-2400-S	120-277	2400mA*1	26-40	241*43*30
		HUP96A1-1WMC-2000-S	120-277	2000mA*1	30-48	241*43*30
		HUP96A1-1WMC-2400-S	120-277	2400mA*1	26-40	241*43*30
	HUP96A1-1WMC-2400-S	120-347	2400mA*1	26-40	241*43*30	
	AWS50A-1UMC-1000	100-277	500-2100mA (Default:1000mA)	22-54	354*238*194	
	AWS800A-1UMC	100-277	5-11.8A*1	27-54	271*131*50	
	AWS800A-1UMC	100-277	14.8A*1	27-54	271*131*50	
	EULP40A-2WMC	120-277	415/620/830mA*2	30-50	280*30*23	
	EULP80A-2WMC	120-277	830/1250/1660mA*2	30-50	360*30*23	
	LUP25A3-2WMC-550	120-277	275/550/550mA	30-45	241*30*23	
	LUP28A3-2WMC-620	120-277	350/490/620mA	30-45	241*30*23	
	LUP45A3-2WMC-1000	120-277	700/850/1000mA	30-45	241*30*23	
	LUP50A3-2WMC-1200	120-277	600/700/1200mA	30-45	241*30*23	



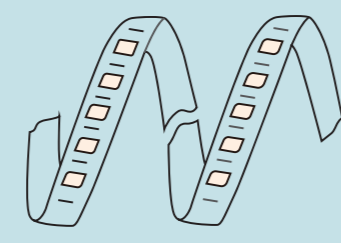

LED Strip

Indoor Drivers



Dimming manner	Output Power	Item No.	Input Voltage <sub>(VAC)</sub>	Output Current Channel	Output Voltage <sub>(VDC)</sub>	Size(L*W*H) (mm)
Dimming	60W	MUP60T-1W2V	120-277	5A*1	12	78*58*29
		MUP60T-1W2W	120-277	2.5A*1	2A	150*43*29
		MUP60T-1W2V	120-277	8A*1	12	213*54*33
	96W	MUP96T-1W2W	120-277	4A*1	2A	213*54*33
		MUP60AT-1W2W	120-277	2.5A*1	12	206*75*40
		MUP60AT-1W2V	120-277	4A*1	2A	206*75*40
0-10V	60W	MUP60AT-1W2W	120-277	2.5A*1	12	240*81*38
		MUP60AT-1W2V	120-277	4A*1	2A	240*81*38
		MUP60A-1W2V	120-277	5A*1	12	242*44*30
	96W	MUP60A-1W2W	120-277	2.5A*1	2A	242*44*30
		MUP96A-1W2V	120-277	8A*1	12	242*44*30
		MUP96A-1W2W	120-277	4A*1	2A	242*44*30
Non-Dimmable	320W	OWP320D-1W2W	120-277	13.3A*1	2A	270*83*33
		OWP320D-3M48V	120-277	6.6A*1	48	270*83*33
		PE10-1W2V	120-277	0.85A*1	12	98*33*25
	10W	PE10-1W2W	120-277	0.42A*1	2A	98*33*25
		PE24-1W2V	120-277	2A*1	12	118*35*26
		PE24-1W2W	120-277	1A*1	2A	118*35*26
	40W	PE40-1W2V	120-277	3.3A*1	12	150*37*30
		PE40-1W2W	120-277	1.66A*1	2A	150*37*30
		PEE20-1W2W	120-277	0.85A*1	2A	118*35*26
	20W	PEE30-1W24V	120-277	1.45A*1	2A	150*37*30
		PEE60-1W2V	120-277	5A*1	12	165.5*42*34
		PEE60-1W2W	120-277	2.5A*1	2A	165.5*42*34
	30W	PEE100-1W2V	120-277	8.34A*1	12	190*32*38
		PEE100-1W24V	120-277	4.17A*1	2A	190*32*38
		PEE150-1W2V	120-277	12.5A*1	12	190*32*38
	150W	PEE150-1W24V	120-277	6.25A*1	2A	190*32*38
		PEE150-1W36V	120-277	4.17A*1	36	190*32*38
		PEE150-1W48V	120-277	3.12A*1	48	190*32*38
60W	UWF60-1W2V	120-277	5A*1	12	145*40.8*22.5	
	UWF60-1W24V	120-277	2.5A*1	2A	145*40.8*22.5	
	UWF96-1W2V	120-277	8A*1	12	220*81*25	
96W	UWF96-1W24V	120-277	4A*1	2A	180*50*27	

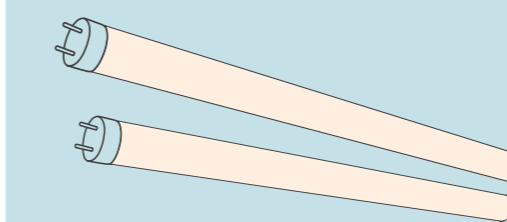

4/3/2/1' T8 T5 Lamp tube

Electronic ballast



Dimming manner	Item No.	Input Voltage <sub>(VAC)</sub>	Output Current Channel	PF	Suitable Lamps
Dimming	EBUS2E3WSP	120-277	0.71-0.3	High	3/2'T8 32/31/30/28/25W, 3'T8 17W, 3'T8 40W
	EBUS2E3HSP	120-277	0.91-0.39	High	3/2'T8 32/31/30/28/25W, 3'T8 17W, 3'T8 40W
	EBUS2LE3WSP	120-277	0.64-0.27	High	3/2'T8 32/31/30/28/25W, 3'T8 17W, 3'T8 40W
	EBUS2P420SP	120	1.62-0.97	High	4/3'T8 32/25W, 4'T8 17W, 3'T8 40W
	EBUS2HE4WSP	120-277	1.24-0.53	High	4/3'T8 32/31/30/28/25W, 4'T8 17W, 3'T8 40W
	EBUS2LE4WSP	120-277	0.82-0.35	High	4/3'T8 32/31/30/28/25W, 4'T8 17W, 3'T8 40W
	EBU4N1L210R55	120	1.62	Normal	4/3'T8 32W, 4/3'T8 25W, 4'T8 17W, 3'T8 25W
	EBUS2N2103SP	120	0.80-0.34	High	2/1'T8 32/31/30/28/17W, 1'T8/40W
	EBUS2N2WSP	120-277	0.46-0.2	High	2/1'T8 32/31/30/28/17W, 1'T8/40W
	EBUS2HE2WSP	120-277	0.62-0.27	High	2/1'T8 32/31/30/28/17W, 1'T8/40W
	EBUS2LE2WSP	120-277	0.4-0.18	High	2/1'T8 32/31/30/28/17W, 1'T8/40W
	EBUS2P2WSP	120-277	0.25-0.82	High	2/1'T8 108/106/88/67W
Non-Dimmable	EBU2P2WPSS	120-277	0.53	High	2/1'T5 35/28/21/14W
	EBUS2P2WPSS	120-277	0.71	High	2/1'T5H0 39/24W; 1'F136W/2611
	EBUS4P2WPSS	120-277	1.00	High	2/1'T5H0 54/49/55/50W
	EBUS4P4WPSS	120-277	2.00	High	4/3'T5H0 54/55/50W
	EBU1P2WPSS	120-277	0.26	High	2/1'CF013W
	EBU1B2WPSS	120-277	0.33	High	2/1'CF018/13W
	EBU2P2WPSS	120-277	0.47	High	2/1'CF028W, 2/1'T1L5C, 1'T1L5C 40-22W, 1'T1L5C 32-22W, 1'CF1842/25W, 1'F136
	EBU4N1L2WR55	120-277	0.62	High	2'F4012 40W, 2'F3412 34W, 2'F3012 30W, 2'F4012CW 25W
	EBU7P2WSP	120-277	1.17	High	2/1'F9612 75W, 2/1'F9612/ES 65W, 2/1'F7212 55W, 2/1'F9612/HO 110W, 2/1'F4812 35W
	EBU10P2WPSS	120-277	1.5A	High	2/1'F9612/HO 110W, 2/1'F9612/HO/ES 95W, 2'F72/60/4812/HO 65/75/60W

HUP-Current Distributor

Switch	Output-A	Output-B
Left	100%	0%
Middle	50%	50%
Right	0%	100%

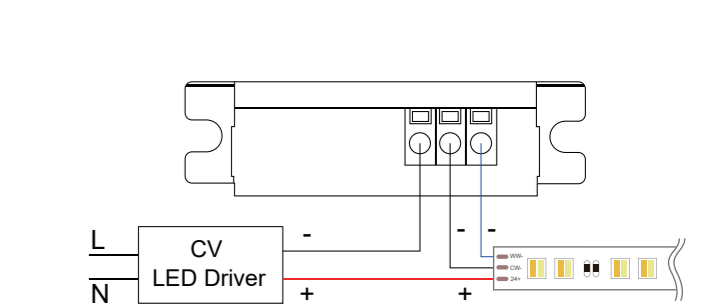
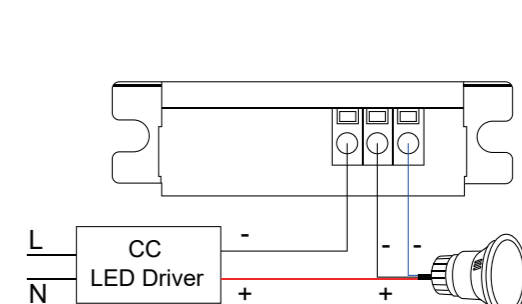
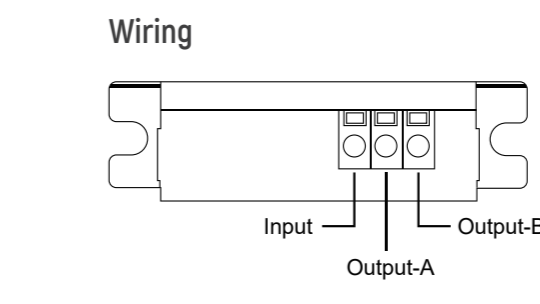
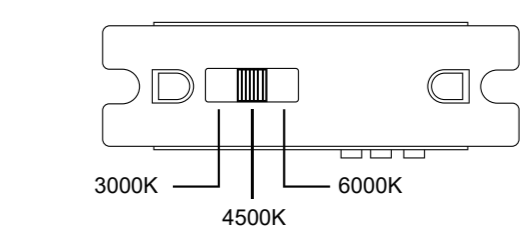
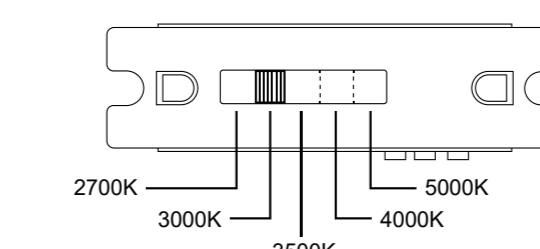

**Euchips Electronics Inc.**  
 ADDR:12328 Valley Blvd, #B, El Monte, CA 91732  
**SHANGHAI EUCHIPS INDUSTRIAL CO., LTD.**  
 ADDR: 309, 3rd Floor, No. 1929 Lianhua South Road, Minhang District, Shanghai, China  
 Email: sales@euchips.us  
 Http://www.euchips.us