

The Tablecraft logo is a red oval with the word "TABLECRAFT" in white, uppercase, serif font. There are horizontal lines above and below the text.

TABLECRAFT

Providing Solutions for over 75 Years
Every Ware. Every Day.

2024 PRODUCT CATALOGUE

Customer Service

+44 1536 400091

salesuk@tablecraft.com



THE TABLECRAFT LEGACY

As a company, TableCraft is focused on the trends and needs of our industry to develop relevant products.

As a partner, TableCraft is focused on providing meaningful solutions that will enhance the operator's experience.

As a family business over 4 generations, TableCraft is focused on fostering strong, long-lasting relationships by serving our customers.

Thank you for all your support through the years and for the many more years to come!

ICONOGRAPHY:



Oven Safe



Induction Ready



Microwave Safe



Dishwasher Safe



Hand Wash Only



Temperature Safe Range



Cash & Carry Select Items



BPA Free



Listed Items



Scan to explore the new eu.tablecraft.com



Smart & Safe Food Practices

European Headquarters
27 Causeway Road, Corby
Northants. NN17 4DU

Customer Service: 01536 400091
salesuk@tablecraft.com

eu.tablecraft.com

1 EA 12148



7 27875 27750 3

©2024 TPC, Inc.

2024 CATALOGUE TABLE OF CONTENTS

BUFFET, CATERING & DISPLAY | 02

BEVERAGE & COUNTER | 40

BAR SOLUTIONS | 52

TABLETOP SOLUTIONS | 74

SERVING SOLUTIONS | 86

DINING ROOM SOLUTIONS | 108

SQUEEZE BOTTLE | 114

KITCHEN TOOLS & FOOD PREP | 126

CARE & USE | 158

TERMS & CONDITIONS | 160

WORLDWIDE SALES | 161

INDEX | 162



ADD ELEVATION TO YOUR PRESENTATION

TableCraft offers an array of products that elevate your food presentation, enhance your buffet line and deliver dependable, durable solutions.



DISPLAY SOLUTIONS | 4

Universal Adapter Bars4
 Cooling Plates & Displays4
 Gastronorm Pans5

CHAFER AND COOKWARE | 6

Quick View (Fuel) Chafers.....6-7
 Food Pans for Chafers8-9
 Tri-Ply Cookware10
 Die Cast Cookware.....11
 Cast Iron Cookware & Servers12-13

CRATES, RISERS & DISPLAYS | 14

Gastronorm Display & Serving Crates.....14-15
 Crate Risers.....15
 Tiered Risers16
 Grab & Go Risers17
 Folding Crate Risers.....17
 Two-Tiered Crate Frame Risers18
 Lazy Susan Rotating Displays.....19
 Forge Collection™20-21
 Tiered and Storage Baskets22
 Grand Master™ Collection23
 Fruit Baskets.....23
 Cereal Dispensers23

RISERS AND DISPLAYS | 24

Cascade Risers™24
 Barclay Risers™24
 Non-Slip Risers.....25
 Nesting Risers25
 Fold-A-Way.....26-27

CAKE STANDS, DOMES, & COVERS | 28

Acacia Collection™ Cake Stands.....28
 Plastic Cake Plates & Domes.....29
 Cake Sets, Stands & Covers.....30
 Half & Full Size Covers.....31

ACCESSORIES & UTENSILS | 32

High Heat Utensils.....32
 Spoon Rests32
 Silicone & Stainless Steel Utensils.....33
 Antimicrobial™ Serving Ladles.....33
 Holden Collection™34-35

ACCESSORIES & DISPOSABLES | 36

Bamboo Picks.....36-37
 Disposable Cones, Cups & Boats38
 Disposable Cone Holders.....39
 Card Holders39



11794 Two-Tiered Riser Frame with:
 (2 ea) CRATE12W Half Size Crate
 (1 ea) CRATE11W Full Size Crate
 Crates sold separately (Food pan not included)

KEEPING IT COOL

Keep food perfectly chilled for up to 3 hours with this versatile solution. Our cooling plates are available in three sizes (Half, Half Long and Full). Use them separately or on stands. For best results, pre-chill cooling plates and cast aluminum bowls and trays in the freezer for 8-12 hours prior to use.



Full Size Cooling Plate shown on Individual Tiered Crate Frame (11448) See page 16 for more details.

UNIVERSAL ADAPTER BARS

- For use with cast aluminium pans in cold or hot well applications
- Use for dividing pans or filling gaps

Item #	Description	Min Order/ Case Pack
ADAPTER BARS – STAINLESS STEEL, MIRROR FINISH		
d.	CWA12 33cm Bar, fits 1/2 Gastronorm Pan	1 ea / 12 ea
e.	CWA20 53.5cm Bar, fits 1/1 Gastronorm Pan	1 ea / 12 ea



COOLING PLATES AND DISPLAYS



Item #	Description	Min Order/ Case Pack
COOLING PLATES – STAINLESS STEEL, BRUSHED FINISH		
a.	CW60100 Full Size, 53 x 32.5 x 4.5cm	1 ea / 4 ea
b.	CW60101 Half Size, 32.5 x 26.5 x 4.5cm	1 ea / 6 ea
c.	CW60103 Half Long Size, 53 x 16 x 4.5cm	1 ea / 8 ea

Low-profile for sleek presentations



Brushed finish resists smudges and finger prints and cleans up easily



Non-slip rubber feet keep plate in place and allow for easy pickup

GASTRONORM MELAMINE PANS

- Not microwave or oven safe
- Not to be kept under heat lamps

AVAILABLE IN 3 COLOURS



SaferFood
SOLUTIONS™

Item #	Description	Min Order/ Case Pack
GASTRONORM SIZE PANS - MELAMINE		
a.	MG2420BK 2/4 GN Black Pan, 20mm Deep	1 ea / 32 ea
	MG2420W 2/4 GN White Pan, 20mm Deep	1 ea / 32 ea
	MG1120BK 1/1 GN Black Pan, 20mm Deep	1 ea / 16 ea
	MG1120W 1/1 GN White Pan, 20mm Deep	1 ea / 16 ea
	MG1165BK 1/1 GN Black Pan, 65mm Deep	1 ea / 16 ea
b.	MG1165W 1/1 GN White Pan, 65mm Deep	1 ea / 16 ea
	MG11100BK 1/1 GN Black Pan, 100mm Deep	7 ea
	MG11100R 1/1 GN Red Pan, 100mm Deep	7 ea
	MG11100W 1/1 GN White Pan, 100mm Deep	7 ea
	MG1265BK 1/2 GN Black Pan, 65mm Deep	1 ea / 16 ea
	MG1265W 1/2 GN White Pan, 65mm Deep	1 ea / 16 ea
	MG12100BK 1/2 GN Black Pan, 100mm Deep	14 ea
	MG12100R 1/2 GN Red Pan, 100mm Deep	14 ea
	MG12100W 1/2 GN White Pan, 100mm Deep	14 ea
	MG1365BK 1/3 GN Black Pan, 65mm Deep	1 ea / 24 ea
	MG1365W 1/3 GN White Pan, 65mm Deep	1 ea / 24 ea
	MG13100BK 1/3 GN Black Pan, 100mm Deep	21 ea
c.	MG13100R 1/3 GN Red Pan, 100mm Deep	21 ea
	MG13100W 1/3 GN White Pan, 100mm Deep	21 ea
	MG1465BK 1/4 GN Black Pan, 65mm Deep	1 ea / 32 ea
	MG1465W 1/4 GN White Pan, 65mm Deep	1 ea / 32 ea

MIX OR MATCH... PRESENT AND SERVE.



CLEARLY, THE BEST WAY TO PRESENT YOUR POINT OF VIEW

QUICK-VIEW FUEL & INDUCTION CHAFERS

- Unique 'stop anywhere' hinge for ease of use, as well as noise reduction
- Available in three colours; mix and match stands and dishes (each sold separately) to create a unique look
- Steam vent offers reduced condensation



Item #	Description	Capacity	Min Order/ Case Pack
1/1 GN STAINLESS STEEL OR PVD COATED STAINLESS STEEL, GLASS WINDOWS			
a. 10422	1/1 GN Chafer, Stainless Steel	8 L	1 ea
10423	1/1 GN Chafer, Stainless Steel with Gold PVD Coating	8 L	1 ea
10424	1/1 GN Chafer, Stainless Steel with Black PVD Coating	8 L	1 ea
b. 10425	1/1 GN Rectangular Frame, Stainless Steel	-	1 ea
10426	1/1 GN Rectangular Frame, Stainless Steel with Gold PVD Coating	-	1 ea
10427	1/1 GN Rectangular Frame, Stainless Steel with Black PVD Coating	-	1 ea
2/3 GN STAINLESS STEEL OR PVD COATED STAINLESS STEEL, GLASS WINDOWS			
c. 10428	2/3 GN Chafer, Stainless Steel	5.7 L	1 ea
d. 10429	2/3 GN Chafer, Stainless Steel with Gold PVD Coating	5.7 L	1 ea
10430	2/3 GN Chafer, Stainless Steel with Black PVD Coating	5.7 L	1 ea
e. 10431	2/3 GN Square Frame, Stainless Steel	-	1 ea
10432	2/3 GN Square Frame, Stainless Steel with Gold PVD Coating	-	1 ea
f. 10433	2/3 GN Square Frame, Stainless Steel with Black PVD Coating	-	1 ea
ROUND - STAINLESS STEEL OR PVD COATED STAINLESS STEEL, GLASS WINDOWS			
g. 10434	Round Chafer, Stainless Steel	4 L	1 ea
10435	Round Chafer, Stainless Steel with Gold PVD Coating	4 L	1 ea
10436	Round Chafer, Stainless Steel with Black PVD Coating	4 L	1 ea
h. 10437	Round Frame, Stainless Steel	-	1 ea
10438	Round Frame, Stainless Steel with Gold PVD Coating	-	1 ea
10439	Round Frame, Stainless Steel with Black PVD Coating	-	1 ea
CHAFER REPLACEMENT PART			
i. 11564	Hydraulic Stop Anywhere Hinge for Chafers, Stainless Steel	-	1 ea / 10 ea

All dishes and stands sold separately



Unique 'stop anywhere' hinge



Steam pan included with every dish



Fuel & induction ready

All models are now available in polished Stainless Steel, Gold PVD Coated or Black PVD Coated



Glass window for quick view of contents

Steam vent



New claw shaped feet

CHAFERS & STANDS AVAILABLE TO MIX & MATCH IN THREE FINISHES



Stainless Steel

Gold

Black

Use without a frame for induction use



Hydraulic Stop Anywhere Hinge

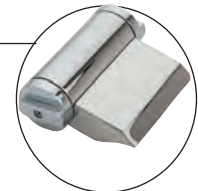



Unique divided food pan



Item #	Description	Capacity	Min Order/ Case Pack
STAINLESS STEEL FOOD PANS WITH POLISHED FINISH			
a.	1/1 GN Food Pan, 54 x 34 x 6.5cm (fits 10422, 10423, 10424)	8.5 L	1 ea / 8 ea
b.	1/2 GN Food Pan, 32.5 x 26.5 x 6.5cm (fits 10422, 10423, 10424)	3.8 L	1 ea / 16 ea
c.	2/3 GN Food Pan, 36 x 32.5 x 6.5cm (fits 10428, 10429, 10430)	5.7 L	1 ea / 8 ea
d.	1/3 GN Food Pan, 32.5 x 6.5 x 6.5cm (fits 10428, 10429, 10430)	2.6 L	1 ea / 16 ea
e.	Round Food Pan, 38.5cm dia x 6.5cm (fits 10434, 10435, 10436)	5.7 L	1 ea / 8 ea
STAINLESS STEEL FOOD PAN WITH MATTE FINISH			
f.	CW40297 Round Divided, 39cm dia x 7cm (fits 10434, 10435 and 10436)	(2) 2.6 L	1 ea / 6 ea

THE INSIDE SCOOP ON OUR POLISHED FOOD PANS



**CHAFER
FOOD PANS**
Add a touch of class to Chafer service using these high-polish food pans.

- Each pan will fit in a variety of chafers



TRI-PLY COOKWARE TO TABLETOP

What does tri-ply mean?

- 18/8 Stainless Steel interior
- Aluminium core
- 18/0 Stainless Steel exterior
- Stainless Steel and Aluminium construction ensures even heat distribution



**HOT
HOLDING**
UP TO 230°C

PROFESSIONAL
BAKEWARE
BY
TABLECRAFT



a



b



c



d

Grill Pan and Wok both feature helper handles for better, more comfortable cooking control



h



i

Sauce Pot and Lid sold separately

NEW



j



e



f



g

Fits CW2034 Roast Pan

Item #	Description	Capacity	Min Order/ Case Pack
TRI-PLY COOKWARE – STAINLESS STEEL, ALUMINIUM			
a.	CW7010 Braiser with Handles, 25.5cm dia x 6.5cm	3.4 L	1 ea / 6 ea
b.	CW7012 Wok with 2 Handles, 24cm dia x 7.5cm	3.4 L	1 ea / 6 ea
c.	CW7020 Grill Pan with Helper Handle, 28cm dia x 4.5cm	3.4 L	1 ea / 4 ea
d.	CW7014 Wok with Helper Handle, 30cm dia x 8cm	5.7 L	1 ea / 4 ea
	CW2042 Oval Pan with 2 Handles, 36 x 24.5 x 12cm	4.5 L	1 ea / 6 ea
e.	CW2044 Oval Pan with 2 Handles, 47 x 27.5 x 11cm	6.3 L	1 ea / 4 ea
f.	CW2030 Roast Pan with 2 Handles, 33.5 x 24.5 x 11cm	4 L	1 ea / 6 ea
	CW2032* Roast Pan with 2 Handles, 41 x 29.5 x 11cm (Not Induction Ready)	6.8 L	1 ea / 4 ea
	CW2034* Roast Pan with 2 Handles, 46.5 x 34.5 x 13.5cm (Not Induction Ready)	12.5 L	1 ea / 2 ea
g.	CW2034L Roast Pan Lid, Fits CW2034 (Lid sold separately)	—	1 ea / 4 ea
MINI-SAUCE POT & LID - STAINLESS STEEL, ALUMINIUM (SOLD SEPARATELY)			
h.	CW7000 Sauce Pot, 16cm dia x 6.5cm, 23cm dia with Handles	950ml	1 ea / 10 ea
i.	CW7000L Lid for CW7000, 16cm dia (Lid sold separately)		1 ea / 20 ea
j.	CW700LM ▶ Glass Lid for CW7000, 16cm dia (Lid sold separately)		1 ea / 20 ea

* Induction ready unless otherwise noted.



DIE CAST COOKWARE

- Use on stove top hot plate, induction ready and oven-safe
- Exterior coating is designed for exposure to high temperatures
- Features a non-stick interior and strong cast handles



Item #	Description	Capacity	Min Order/ Case Pack
DIE CAST ALUMINIUM – STAINLESS STEEL			
a.	CWDC1030 Sauce Pan with Lid, 32 x 25.5 x 20.5cm	5.7 L	1 ea / 6 ea
b.	CWDC1070 Grill Pan, 45.5 x 27.5 x 5.5cm	-	1 ea / 6 ea
c.	10454 Grill Pan with Flat Plate, 45.5 x 27.5 x 5.5cm	-	1 ea / 6 ea
d.	CWDC1040 Wok with Lid, 33cm dia x 19cm, 39.5cm dia with Handles	3.4 L	1 ea / 6 ea
e.	CWDC1050 Casserole with Lid, 32 x 25 x 16.5cm	3.4 L	1 ea / 6 ea



CAST IRON COOKWARE

- Pre-seasoned, naturally non-stick & easy to clean
- Simple solution for cooking and serving from one dish
- Durable and dependable, a good option for extended use
- For more detailed care and use instructions see page 158
- Safe to -17°C



Item #	Description	Capacity	Min Order/ Case Pack
PLATTER, PANS AND WOK			
a.	CW30152 Fajita Platter, 19cm dia x 3.5cm, 26cm dia with Handles	710ml	1 ea / 6 ea
b.	CW30114 Square Pan, 27 x 27 x 5.5cm, 33cm dia with Handles	2.6 L	1 ea / 4 ea
c.	CW30116 Wok, 36.5 dia x 11.5cm, 44.5cm dia with Handles	5.7 L	1 ea / 4 ea
d.	CW30118 Pizza Pan, 34.5cm dia x 2cm, 44.5cm dia with Handles	—	1 ea / 4 ea
OVAL AU GRATIN			
e.	CW30100 21.5 x 15.5 x 6.5cm, 27cm dia with Handles	710ml	1 ea / 6 ea
ROUND SKILLETS			
f.	CW30122 10cm dia x 3.5cm, with 9.5cm Handle	90ml	1 ea / 6 ea
g.	CW30124 14.5cm dia x 3cm, with 12cm Handle	240ml	1 ea / 6 ea
h.	CW30108 14cm dia x 4cm, with 9cm Handle	355ml	1 ea / 6 ea

CAST IRON WORKS



CAST IRON COOKWARE



Item #	Description	Capacity	Min Order/ Case Pack
ROUND CASSEROLES WITH LID			
a. CW30110	10cm dia x 8.5cm, 13cm dia with Handles	240ml	1 ea / 4 ea
CW30148	13cm dia x 9.5cm, 18cm dia with Handles	530ml	1 ea / 6 ea
OVAL CASSEROLES WITH LID			
b. CW30112	12.5 x 9.5 x 8cm, 15.5cm dia with Handles	240ml	1 ea / 4 ea
ROUND SERVERS			
c. CW30102	12.5cm dia x 4cm, 16.5cm dia with Handles	240ml	1 ea / 6 ea
CW30104	13.5cm dia x 4.5cm, 18cm dia with Handles	355ml	1 ea / 6 ea
CW30142	15.8cm dia x 4cm, 20.5cm dia with Handles	530ml	1 ea / 6 ea
CW30140	18.4cm dia x 5cm, 23cm dia with Handles	830ml	1 ea / 6 ea
SQUARE SERVERS			
d. CW30150	12.5 x 12.5 x 4cm, 17.5cm width with Handles	355ml	1 ea / 6 ea
SIZZLE PLATTER			
e. 10746	Oval, 23.5 x 17 x 1.5cm	—	1 ea / 6 ea
f. 10764	Oval Acacia Wood Underliner for Cast Iron Oval Skillet (10746)	—	1 ea / 40 ea
KETTLE			
g. CW30151	13cm dia x 8cm	475ml	1 ea / 6 ea
FAJITA SERVING BOARDS – ACACIA			
h. 10709	Rectangular, 47 x 22.5 x 2cm, Fits CW30100 or 10746	—	1 ea / 12 ea
i. 10710	Oval, 43.5 x 31 x 2cm, Fits CW30100 or 10746	—	1 ea / 12 ea

For more detailed care and use instructions see page 158 in back of book.





GASTRONORM DISPLAY CRATES



High quality designs that bring a rustic, yet contemporary, feel to your serving presentation

Handles for convenient transporting

Solid wood construction and reinforced corners



c

Designed to fit GN size food pans



d

Item #	Description	Min Order/ Case Pack
WHITE PAINTED WOOD		
a. CRATE11W	1/1 GN Crate, 70mm Deep	1 ea / 8 ea
CRATE12W	1/2 GN Crate, 70mm Deep	1 ea / 14 ea
b. CRATE13W	1/3 GN Crate, 70mm Deep	1 ea / 14 ea
CRATE14W	1/4 GN Crate, 70mm Deep	1 ea / 8 ea
ACACIA WOOD		
CRATE11	1/1 GN Crate, 70mm Deep	1 ea / 8 ea
CRATE114	1/1 GN Crate, 110mm Deep	1 ea / 3 ea
CRATE116	1/1 GN Crate, 160mm Deep	1 ea / 3 ea
CRATE12	1/2 GN Crate, 70mm Deep	1 ea / 8 ea
c. CRATE124	1/2 GN Crate, 110mm Deep	1 ea / 10 ea
CRATE126	1/2 GN Crate, 160mm Deep	1 ea / 14 ea
CRATE13	1/3 GN Crate, 70mm Deep	1 ea / 14 ea
CRATE134	1/3 GN Crate, 110mm Deep	1 ea / 10 ea
CRATE136	1/3 GN Crate, 160mm Deep	1 ea / 6 ea
CRATE14	1/4 GN Crate, 70mm Deep	1 ea / 14 ea
BLACK PAINTED WOOD		
d. CRATE11BK	1/1 GN Crate, 70mm Deep	1 ea / 8 ea
CRATE114BK	1/1 GN Crate, 110mm Deep	1 ea / 3 ea
CRATE12BK	1/2 GN Crate, 70mm Deep	1 ea / 8 ea
CRATE13BK	1/3 GN Crate, 70mm Deep	1 ea / 14 ea

SERVICE WITH **STYLE**

GASTRONORM SERVING & DISPLAY CRATES



- These trays bring a refined rustic feel to your serving presentation
- Designed to fit standard full or half size food pans
- Features solid plank bottom and handles for convenient use
- Full size crate fits standard 30 x 45cm placemats

Item #	Description	Min Order/ Case Pack
ACACIA WOOD		
a. CRATESB11	1/1 GN Crate, Solid Base, 53 x 32.5 x 7cm	1 ea / 8 ea
BLACK PAINTED WOOD		
b. CRATESB11BK	1/1 GN Crate, Solid Base, 53 x 32.5 x 7cm	1 ea / 8 ea



RISE TO ANY OCCASION

Our crate risers bring height and attraction to your displays. Crate styles feature one chalkboard panel for custom labelling and decorating. Crates also nest together for storage when not in use.

CRATE RISERS



Item #	Description	Min Order/ Case Pack
NATURAL OR DISTRESSED FIRWOOD		
c. *RCBCRATE1	Natural Wood 3pc Set, Small 35 x 25.5 x 18cm, Medium 40.5 x 30 x 23.5cm, Large 49 x 34.5 x 26.5cm	1 set
*RCBCRATE1SM	Natural Wood 2pc Set, Small 35 x 25.5 x 18cm, and Medium 40.5 x 30 x 23.5cm	1 set
d. *RCBCRATE2	Distressed Wood 3pc Set, Small 30.5 x 21 x 15.5cm, Medium 37 x 23 x 17.5cm, Large 42 x 30 x 19cm	1 set





TIERED CRATE FRAMES

Display and merchandise your baked goods, fruit, or grab & go prepacked foods with these new frames now available in white that fit our full-size and half-size crates perfectly.

- Black or White Powder Coated Steel
- Collapsible design for display or storage
- See our collection of crates that pair with these frames



Shown with our 1/2 GN Black Painted Wooden Crate (CRATE12BK), see page 14.

NEW



View the benefits of our Tiered Crate Frames!



Collapse down to store flat

Item #	Description	Min Order/ Case Pack
INDIVIDUAL TIERED FRAMES – WHITE POWDER COATED STEEL		
a. 11797 ▶	Fits GN 1/2 Wooden Crates 29 x 34 x 11.5cm	1 ea / 6 ea
b. 11798 ▶	Fits GN 1/1 Wooden Crates 55.5 x 34 x 11.5cm	1 ea / 6 ea
GRAB & GO TWO TIERED FRAME – BLACK POWDER COATED STEEL		
c. 11447	Fits GN 1/2 Wooden Crates 29 x 34 x 11.5cm	1 ea / 6 ea
d. 11448	Fits GN 1/1 Wooden Crates 55.5 x 34 x 11.5cm	1 ea / 6 ea



Works with our Half and Full Size Gastronorm Crates. Shown here with CRATE11, see pages 14-15 for our full assortment.

GRAB & GO TWO-TIERED FRAMES

Display and merchandise your baked goods, fruits, or grab & go prepacked foods with these new frames that fit our 1/1 GN and 1/2 GN Crates, Cooling Plates and Melamine Platters.

- Black or White powder coated steel
- See our collection of crates that pair with these frames
- Ships flat; lock & channel design for quick, easy assembly



g

Works with our 1/2 GN and 1/1 GN Crates. Shown here with CRATE11 (top) and CRATE114 (bottom), see page 14 for our full assortment.

Item #	Description	Min Order/ Case Pack
GRAB & GO TWO TIERED FRAME, WHITE POWDER COATED STEEL		
e. 11795 ▶	38.5 x 38.5 x 33cm (Fits GN 1/2)	1 ea
f. 11796 ▶	59.5 x 45 x 33cm (Fits GN 1/1)	1 ea
GRAB & GO TWO TIERED FRAME, BLACK POWDER COATED STEEL		
g. 11622	38.5 x 38.5 x 33cm (Fits GN 1/2)	1 ea
h. 11623	59.5 x 45 x 33cm (Fits GN 1/1)	1 ea



e

Works with our Half and Full Size Cooling Plates, shown here with CW60101, see page 32.

Keep products easily accessible with this space-efficient design.



Lip helps keep crates in place.

f

FOLDING CRATE STANDS



Perfect for room service, breakfast in bed or as a riser on your serving presentation. Our new folding crate stands work with our 1/1 GN Crates, Cooling Plates and 1/1 Melamine Platters.

- Available in both Acacia and Black Painted Rubberwood
- Integrated cutouts for easy handling while transporting stand and crate
- Do not submerge in water, wipe with a damp cloth and dry immediately
- 67.5 x 34 x 22cm (open) and 54.5 x 34 x 3cm (closed)
- Stackable for convenient storage
- Weight limit: 12kg



i

19cm clearance

Item	Description	Min Order/ Case Pack
FOLDING CRATE STANDS (FITS GN 1/1)		
i. 10765	Folding Crate Stand, 67.5 x 34 x 22cm, Acacia	1 ea / 4 ea
j. 10766	Folding Crate Stand, 67.5 x 34 x 22cm, Black Painted Rubberwood	1 ea / 4 ea

HELPFUL HINT:

We do not recommend using folding crate stands to transport heavy items for display; position stand, add crate, and fill.



j

Legs stay in place when in use, collapse down to store flat

TAKING IT TO THE NEXT LEVEL

TWO-TIERED CRATE FRAME RISER

Perfect for breakfast buffets, grab-and-go stations or merchandising

Each tier of this riser display is designed to fit: (1 ea) 1/1 GN, (2 ea) 1/2 GN, (3 ea) 1/3 GN or (4 ea) 1/4 GN Size Wooden Crates featured on page 14, Wooden Crates sold separately

- Ships flat. Lock & channel design for quick, easy assembly



Removable chalkboard panel to customise presentation

Features adjustable shelves so you can display flat or on an angle



a

NEW



b

Item #	Description	Min Order / Case Pack
TWO-TIERED CRATE FRAME RISER – POWDER COATED STEEL, BLACK OR WHITE		
a. 11000	Black, 54.5 x 34.5 x 56.5cm	1 ea
b. 11794 ▶	White, 54.5 x 34.5 x 56.5cm	1 ea

Chalkboard sign can be removed for more space saving display options.



11000 Two-Tiered Riser Frame with:
(2 ea) CRATE12 1/1 GN Wooden Crate
(2 ea) CRATE124 1/2 GN Wooden Crate



11000 Two-Tiered Riser Frame with:
(1 ea) CRATE114BK 1/1 GN Wooden Crate
(1 ea) CRATE11BK 1/1 GN Wooden Crate
Crates sold separately (Food pan not included)



11000 Two-Tiered Riser Frame with:
(1 ea) CW60100 Full Size Cooling Plate
(1 ea) CRATE11W Full Size Crate
Crates sold separately (Food pan not included)



11794 Two-Tiered Riser Frame with:
(2 ea) CRATE12W 1/2 GN Wooden Crate
(1 ea) CRATE11W 1/1 GN Wooden Crate
Crates sold separately (Food pan not included)



LAZY SUSAN ROUND SERVER

Our new lazy susan offers a turntable solution to your tabletop, countertop, or buffet line. Display anything from bakery items, entrees, appetisers, or desserts while offering a solution to easily share dishes among diners or easily grab condiments from the center of the table.

- Acacia wood
- Available in 3 different sizes
- Hand wash only



Scan code to view a video on our Lazy Susan Round Servers.



Item #	Description	Min Order/ Case Pack
LAZY SUSAN – ACACIA WOOD		
a. 11828 ▶	33cm dia x 4cm rotating disc	1 ea / 6 ea
b. 11829 ▶	38cm dia x 4.5cm rotating disc	1 ea / 6 ea
c. 11830 ▶	45.5cm dia x 4cm rotating disc	1 ea / 6 ea

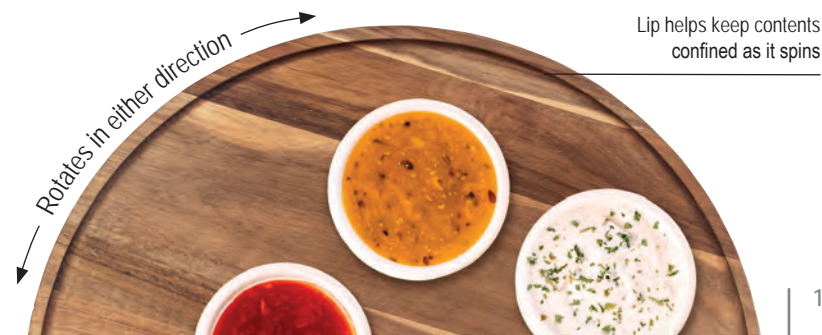



FORGE AHEAD

e

FORGE COLLECTION™ BASKETS



Perfect baskets for indoor and outdoor service that provide rustic style to your tabletop or buffet. They can also be used for grab & go service as well as placing a liner inside for tabletop service.

- Black Galvanized Steel
- Hand wash only

NEW

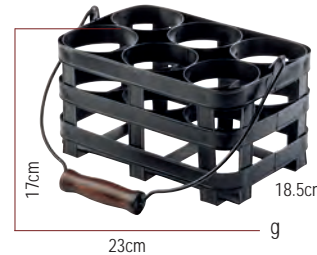
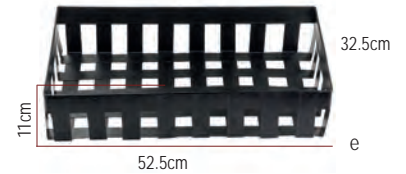
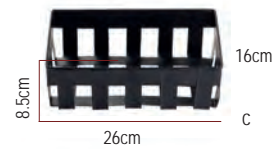
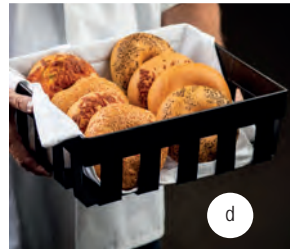
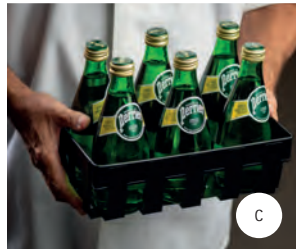

BUFFET & CATERING
FORGE COLLECTION™

Item #	Description	Min Order/ Case Pack
GALVANIZED STEEL, BLACK COATED		
a. 11692 ▶	Round Basket, 20.5cm dia x 7cm	1 ea / 36 ea
b. 11693 ▶	Round Basket, 26cm dia x 10cm	1 ea / 36 ea
c. 11694 ▶	Rectangular Basket, 26 x 16 x 8.5cm (GN 1/3 size)	1 ea / 36 ea
d. 11695 ▶	Rectangular Basket, 32.5 x 26.5 x 11cm, fits 11622 Display (GN 1/2 size)	1 ea / 6 ea
e. 11696 ▶	Rectangular Basket, 52.5 x 32.5 x 11cm, fits 11623 and 11000 Displays (GN 1/1 size)	1 ea / 6 ea
f. 11846 ▶	Bottle Caddy, 18.5 x 18 x 17cm, holds (4) 63mm bottles	1 ea / 18 ea
g. 11847 ▶	Bottle Caddy, 23 x 18.5 x 17cm, holds (6) 63mm bottles	1 ea / 12 ea



Scan code to view a video on our Forge Collection™

BRIGHTEN UP BREAKFAST, BRUNCH & BEYOND

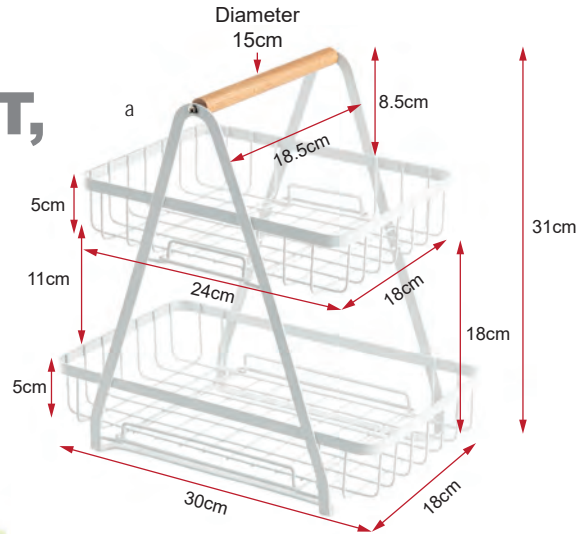

TWO-TIERED BASKET DISPLAY AND STORAGE BASKETS WITH WOODEN HANDLES



Create a brighter, lighter grab & go station for breakfast items, baked goods, fruits, every ware. every day.

- White Powder Coated Steel with Wooden Handles
- 2-Tier basket display requires minimal assembly

NEW

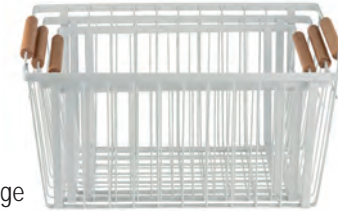

Scan code to view a video on our Baskets.

Storage baskets nest together for compact storage

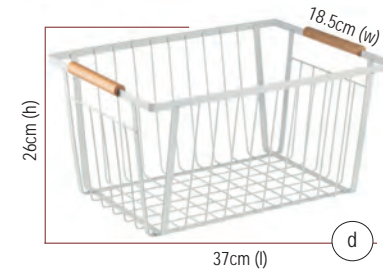
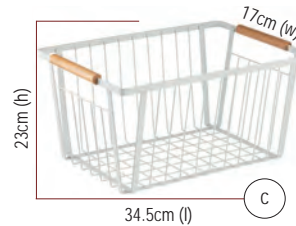
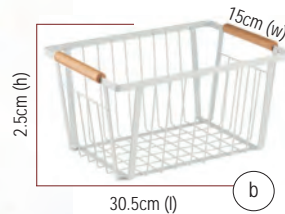

Item #	Description	Min Order/ Case Pack
WHITE POWDER COATED METAL WITH WOODEN HANDLES		
a.	11784 ▶ 2-Tier Basket Display, White, 30 x 23 x 31cm (overall) Small Basket (top) 24 x 18 x 5cm, Large Basket (bottom) 30 x 18 x 5cm	1 ea / 6 ea
b.	11785 ▶ Storage Basket with Handles, White 30.5 x 20.5 x 15cm	1 ea / 6 ea
c.	11786 ▶ Storage Basket with Handles, White 34.5 x 23 x 17cm	1 ea / 6 ea
d.	11787 ▶ Storage Basket with Handles, White 37 x 26 x 18.5cm	1 ea / 6 ea

GRAND MASTER™ TRANSFORMER® COLLECTION



Versatile wire baskets can be filled as-is, with a cloth insert, melamine bowl and more. All baskets feature adjustable legs for versatile display height and angle options.

Item #	Description	Min Order/ Case Pack
BLACK POWDER COATED METAL		
a.	GMT13105 Rectangular, 1/2 GN Size, 125mm Deep	1 ea / 6 ea
b.	GMT21125 Rectangular, 1/1 GN Size, 125mm Deep	1 ea / 6 ea
c.	GMT2412 Oblong, 61 x 30.5 x 15cm	1 ea / 4 ea
	GM1212 Angled Square, 30.5 x 30.5cm, 6.5cm Front, 11.5cm Back	1 ea / 4 ea
d.	GM1519 Angled Square, 38 x 49.5cm, 6.5cm Front, 20.5cm Back	1 ea / 4 ea
	GM1608 Rectangular, 40.5 x 20.5 x 11cm	1 ea / 4 ea
e.	GM2113 Rectangular, 53.5 x 33.5 x 13.5cm	1 ea / 4 ea

TRANSFORMS YOUR PLACE TO SAVE YOU SPACE



Raised up 1 level

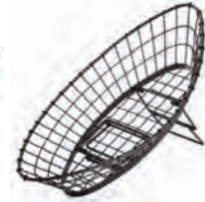

Angled up 2 levels



d



FRUIT & CEREAL DISPENSERS



Save space and keep fruit organised on your buffet line, while bringing a touch of the unusual to your healthy fruit display with these fun metal baskets. Suitable for all single-serve fruit; ideal for grab-and-go and for point of sale displays.

Item #	Description	Min Order/ Case Pack
FRUIT BASKETS, CHROME PLATED WIRE		
f.	FC1649 Curved Basket, 35.5 x 16 x 45.5cm (Maximum fruit diameter 10.5cm)	1 / 12 ea
CEREAL DISPENSER, POLYCARBONATE, STAINLESS STEEL		
g.	693 3 Compartment Rotating Cereal Dispenser, ((3) 8.5 L capacity, 49.5 x 49.5 x 67.3cm	1 ea

FRUIT BASKET



CEREAL DISPENSER





STEP IT UP

Display on or in risers
Mix or match sets



BARCLAY RISERS™



- Set of three risers nest together for easy storage

Item #	Description	Min Order/ Case Pack
SQUARE-WOOD, BRUSHED STAINLESS STEEL OR BAMBOO		
a.	WBK3 3-Pc Set, Black, Wood Set Includes: 12.5, 17.5 & 23cm	1 set / 2 sets
b.	RS3 3-Pc Set, Brushed S/S Set Includes: 12.5, 17.5 & 23cm	1 set / 2 sets
c.	WBAM3 3-Pc. Set, Bamboo Set Includes: 12.5, 17.5 & 23cm	1 set / 2 sets



CASCADE RISERS™



- Versatile and attractive buffet solution, can be nested together or fanned apart
- Set of 3: Small (44x18x11.5cm) Medium (48.5x18x15.5cm) Large (56x18x18cm)

Item #	Description	Min Order/ Case Pack
d.	RACA300 Acacia	1 set
e.	RBAM300 Bamboo	1 set
f.	RBK300 Black painted wood	1 set

SUPPORT SYSTEMS

Our riser collections can play a supporting role in any buffet line catering event or tablescape with ease and versatility.

NON-SLIP RISERS



15 x 15cm top plate
17.5 x 17.5cm footprint



Item #	Description	Min Order/ Case Pack
CHROME PLATED OR BLACK POWDER COATED		
a. CR3	3-Pc Set, Chrome Plated 15 x 15 x 5cm / 15 x 15 x 7.5cm / 15 x 15 x 10cm	1 set / 8 sets
b. BKR4	4-Pc Set, Black 5cm H / 7.5cm H / 10cm H / 15cm H	1 set / 6 sets

NESTING RISERS



- Multi-purpose design—can be used as a base for a bowl or to elevate your dishes
- Set of three graduated-size risers nest together for easy storage

Item #	Description	Min Order/ Case Pack
BRUSHED STAINLESS STEEL		
c. RR3	Set Includes: 20cm dia x 22.5cm H, 17.5cm dia x 15cm H, 15cm dia x 7.5cm H	1 set / 2 sets



POP-UPS



a

b

c

FOLD-A-WAY™ RISER SET



- A charming way to display a variety of different sized bowls and platters
- Collapsible design helps to save valuable storage space
- Features heat safe, non-slip grips and safely holds up to 15kg
- Available in three sizes : Small (19 x 19 x 18cm),
Medium (27 x 27 x 25cm)
Large (30 x 30 x 38cm)

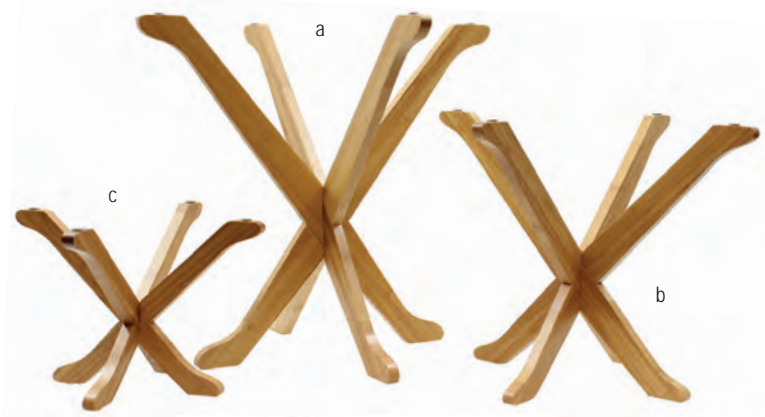

Item #	Description	Min Order/ Case Pack
FOLD-A-WAY™ RISERS – BAMBOO		
a. RFTT3BAML	Large Bamboo Riser, 30 x 30 x 38cm	1 ea / 12 ea
b. RFTT3BAMM	Medium Bamboo Riser, 27 x 27 x 25cm	1 ea / 12 ea
c. RFTT3BAMS	Small Bamboo Riser, 19 x 19 x 18cm	1 ea / 12 ea
FOLD-A-WAY™ RISERS – BLACK		
d. RFTT3BKL	Large Black Riser, 30 x 30 x 38cm	1 ea / 12 ea
e. RFTT3BKM	Medium Black Riser, 27 x 27 x 19cm	1 ea / 12 ea
f. RFTT3BKS	Small Black Riser, 19 x 19 x 18cm	1 ea / 12 ea



ACACIA COLLECTION™ CAKE PLATE, STANDS & DOME



Upgrade your buffet or serving presentation with these new cake plates, stands and cake dome that fit perfectly into our Acacia Collection™. Natural Acacia wood provides warm, earthy texture. Perfect for dressing up your buffet or serving meat and cheese boards, appetisers, entrees and desserts.

- Acacia wood finish
- Cake dome made from acrylic with an acacia wood knob
- Do not submerge in water, wipe clean with a damp cloth and dry immediately.



Item #	Description	Min Order/ Case Pack
a.	11440 Round Cake Plate, 31.5cm dia x 1.5cm	1 ea / 12 ea
b.	11441 Round Cake Stand, Un-assembled, 31.5cm dia x 15cm	1 ea / 6 ea
c.	11442 Round Cake Stand, Un-assembled, 31.5cm dia x 22.5cm	1 ea / 6 ea
d.	11443 Round Cake Dome, Clear Acrylic /Acacia Wooden Handle, 30cm dia x 14.5cm	1 ea / 8 ea
e.	PCD1 Round Cake Dome, Clear, 30.5cm dia x 14.5cm	1 ea / 6 ea





NEW

PLASTIC (SAN) CAKE PLATE, STANDS & DOME



These new plastic cake plates, stands, and domes add style to your serving presentation. They are durable and clear so you can easily see your appetizer, dessert, bakery, or sandwich item being displayed.

- Made from BPA free plastic (SAN)
- Round and rectangular options available
- Easy to clean, dishwasher safe

Item #	Description	Min Order/ Case Pack
a.	11884 ▶ Round Cake Dome, Clear, 30cm dia x 22cm	1 ea / 6 ea
b.	11885 ▶ Round Cake Stand, Clear, 32.5cm dia x 13.5cm	1 ea / 2 ea
c.	11886 ▶ Rectangular Cake Plate, Clear, 37.5x 18.5 x 3cm	1 ea / 12 ea
d.	11887 ▶ Rectangular Cake Cover, Clear, 34.5 x 15 x 19.5cm	1 ea / 2 ea



WE'VE
GOT YOU
COVERED



a (2-piece set)



b (2-piece set)



e



f



g



h

CAKE SETS STANDS & COVERS

- Stainless Steel stands and cake plates
- Polystyrene covers



Item #	Description	Min Order/ Case Pack
CAKE SETS		
a.	821422 Cake Stand / Cover Set, 32.5 x 35cm H	1 ea
b.	*H820P422 Cake Plate / Cover Set, 33 x 20.5cm H	1 ea
STANDS & COVERS		
c.	422 Metal Handle Cover, 30.5cm dia x 19cm H	6 ea
d.	H820P Low Profile Cake Plate, 33cm dia x 3cm H	1 ea / 12 ea
e.	421 Polystyrene Cover with Handle, 30.5cm dia x 19cm H	6 ea
	821U Unassembled Stand, 32.5cm dia x 7.5cm H	1 ea / 6 ea
CAKE DOME, SAN PLASTIC		
f.	PCD1 Cake Dome, 30.5cm dia x 14.5cm H	1 ea / 6 ea
g.	PCD2 Cake Dome, Square Edge, 31cm dia. 11.5cm Height	1 ea / 3 ea
h.	11519 Round Cake Dome Clear, SAN Plastic 28cm dia x 15.5cm	1 ea / 6 ea

HALF SIZE AND RECTANGULAR COVER

DISPLAY FOR TRAYS & CRATES

Dome displays keep your food covered and fresh on the serving line. Half Size Cover fits our Frostone Collection™ Black Slate Tray (MG2EU). Rectangular Full Size Cover can be use with our 1/1 GN crates.



- Keep your food covered and fresh on the serving line
- Coordinating crates and trays sold separately
- Made of polycarbonate plastic



b

Tray for reference only



Half Size Cover shown with Frostone Collection™ Black Slate Tray (MG2EU) see page M24, sold separately

BUFFET & CATERING
CAKE STANDS, COVERS & DOMES

Item #	Description	Min Order/ Case Pack
POLYCARBONATE		
a. 11688 ▶	Rectangular Half Size Cover, 33.5 x 27.5 x 19cm	1 ea
b. PC1	Rectangular Full Size Cover, 54.5 x 33.5 x 19cm	1 ea



Easy rollopt cover with lip to keep it in place while serving and displaying.

HIGH HEAT UTENSILS

Upgrade your kitchen tools with these NSF certified high heat tools. Never leave a scratch or mark with these non-abrasive silicone tools.

- Heat resistant up to 204°C
- One-piece construction, odour and stain resistant
- Conveniently packaged for Cash & Carry



Item #	Description	Min Order/ Case Pack
HIGH HEAT TOOLS – SILICONE OVER NYLON, GREY		

a.	11834 ▶ Wide Spatula Spurtle, 7.5 x 2 x 32cm	1 ea / 6 ea
b.	11835 ▶ Narrow Spatula Spurtle, 5 x 2 x 33cm	1 ea / 6 ea
c.	11836 ▶ Wide Slotted Spatula Spurtle, 7.5 x 2 x 26.5cm	1 ea / 6 ea
d.	11837 ▶ Angled Spatula Spurtle, 5.5 x 2 x 26.5cm	1 ea / 6 ea
e.	11838 ▶ Slotted Spurtle, 5 x 2 x 26.5cm	1 ea / 6 ea
f.	11839 ▶ Solid Spurtle, 5 x 1.5 x 22cm	1 ea / 6 ea
g.	11840 ▶ Narrow Spatula Spurtle, 2.5 x 1.5 x 22cm	1 ea / 6 ea
h.	11841 ▶ Small Basting Brush, 3.5 x 1.5 x 21cm	1 ea / 6 ea
i.	11842 ▶ Large Basting Brush, 4.5 x 1.5 x 27.5cm	1 ea / 6 ea
j.	H3900GY 150ml Ladle, 8.5 x 6.5 x 27.5cm	1 ea / 6 ea
k.	H3902GY Spoon, 8.5 x 3 x 29cm	1 ea / 6 ea
l.	H3903GY Perforated Spoon, 10 x 2.5 x 34.5cm	1 ea / 6 ea
m.	H3905GY Slotted Turner, 8 x 3.5 x 30.5cm	1 ea / 6 ea
n.	H3909GY Spatula, 5.5 x 1.5 x 26cm	1 ea / 6 ea
o.	H3910GY Spatula Spoon, 6 x 1.5 x 26cm	1 ea / 6 ea



SPOON REST

Item #	Description	Min Order/ Case Pack
STAINLESS STEEL		
HB1	Single Spoon Rest, Brushed Finish, 20.5 x 10 x 4cm	12 ea / 12 ea



SILICONE & STAINLESS STEEL UTENSILS

- Stainless Steel core with silicone exterior construction provides a durable, flexible and scratch-resistant serving option
- Heat safe up to 204°C

Item #	Description	Capacity	Min Order/ Case Pack
SILICONE & STAINLESS STEEL			
a.	39100 Tongs, 18 x 11.5 x 4.5 cm	-	1 ea / 6 ea
b.	39101 Tong, 22 x 11.5 x 4 cm	-	1 ea / 6 ea
c.	39102 Tongs, 16.5 x 4.5 x 30.5 cm	-	1 ea / 6 ea
d.	10050 Serving Ladle, 5.5 x 5 x 29 cm	30ml	1 ea / 6 ea
e.	10051 Serving Ladle, 6.5 x 6 x 29.5 cm	60ml	1 ea / 6 ea
f.	10052 Serving Ladle, 8 x 8 x 31 cm	118ml	1 ea / 6 ea
g.	10053 Fish Turner, 8 x 2 x 35 cm	-	1 ea / 6 ea
h.	10054 Slotted Spatula, 8 x 6 x 33 cm	-	1 ea / 6 ea
i.	10055 Solid Spatula, 8 x 6 x 33 cm	-	1 ea / 6 ea

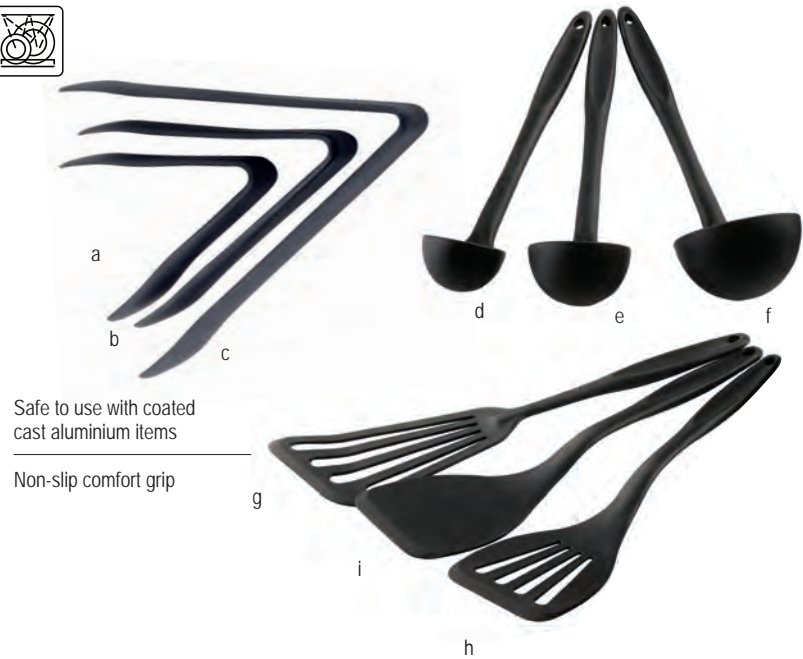

Safe to use with coated cast aluminium items

Non-slip comfort grip

BUFFET & CATERING
HIGH HEAT, SILICONE & ANTIMICROBIAL UTENSILS

ANTIMICROBIAL™ SERVING LADLES



Antimicrobial-infused vinyl handles provide protection against contamination from human contact and food residues. It is safe for food contact and will not wash or wear away from use or cleaning. This antimicrobial formula is USA Environmental Protection Agency (EPA) registered and EU Biocidal Products Regulation (BPR) certified.

Item #	Description	Capacity	Min Order
ANTIMICROBIAL MEASURING LADLES – STAINLESS STEEL			
j.	AM5301BK 1oz Measuring Ladle	30ml	1 ea / 6 ea
k.	AM5302BK 2oz Measuring Ladle	60ml	1 ea / 6 ea
l.	AM5303BK 3oz Measuring Ladle	90ml	1 ea / 6 ea
m.	AM5304BK 4oz Measuring Ladle	120ml	1 ea / 6 ea
n.	AM5306BK 6oz Measuring Ladle	180ml	1 ea / 6 ea

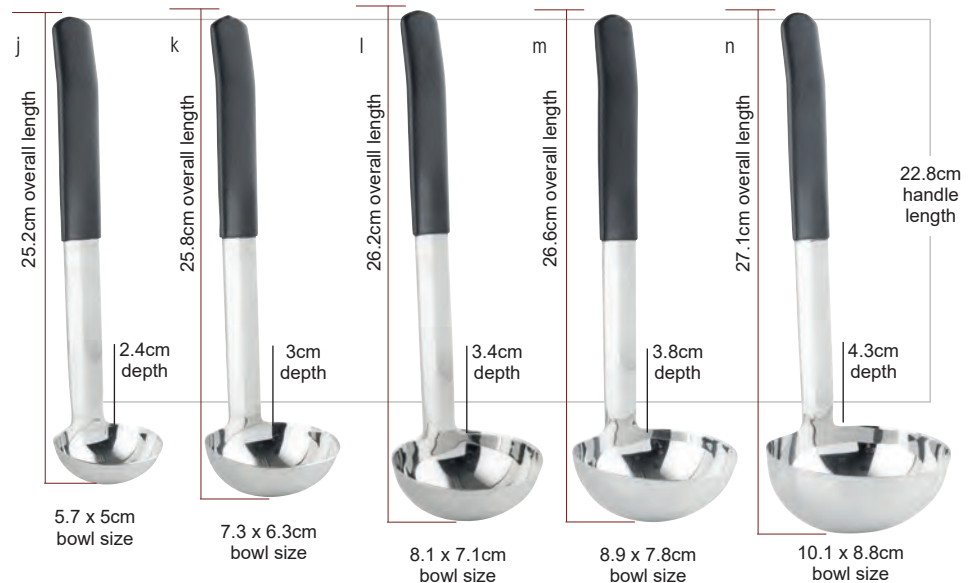

HOLDEN COLLECTION™ **NEW**

Our Holden Collection™ is ergonomically designed to achieve ideal balance, weight and feel required for serving. After service, these tools go right in the dishwasher, reducing cleanup time.

- Stylish and easy-to-use serving utensils for your buffet
- Features brushed finish handles and mirror finish heads for a unique serving presentation
- Utensils have a hollow handle with the exception of the tongs



Packaged for Cash & Carry



Item	Description	Min Order/ Case Pack
------	-------------	-------------------------

HOLDEN COLLECTION™ UTENSILS – 18/0 OR *18/8 STAINLESS STEEL

a.	11626 ▶ Solid Spoon, 30 x 6.5 x 3.5cm	1 ea / 12 ea
b.	11627 ▶ Slotted Spoon, 30 x 6.5 x 3.5cm	1 ea / 12 ea
c.	11628 ▶ Notched Spoon, 30 x 6.5 x 3.5cm	1 ea / 12 ea
d.	11629 ▶ Two-Tine Fork, 28.5 x 2 x 2.5cm	1 ea / 12 ea
e.	11630 ▶ Four-Tine Fork, 27.5 x 4.5 x 2cm	1 ea / 12 ea
f.	11631 ▶ 30ml Ladle with Spout, 30 x 9 x 5cm	1 ea / 12 ea
g.	11632 ▶ 60ml Ladle with Spout, 32 x 11 6.5cm	1 ea / 12 ea
h.	11633 ▶ 120ml Soup Ladle, 33 x 9 x 7.5cm	1 ea / 12 ea
i.	11634 ▶ Cake Server, 28 x 5.5 x 3cm	1 ea / 12 ea
j.	11635 ▶ Pie Server, 30.5 x 10 x 4.5cm	1 ea / 12 ea
k.	11636 ▶ Slotted Turner, 37.5 x 8.5 x 2cm	1 ea / 12 ea
l.	11637 ▶ Skimmer, 37.5 x 11 x 4.5cm	1 ea / 12 ea
m.	11638 ▶ Bread Knife, 35 x 2 x 1.5cm	1 ea / 12 ea
n.	11639 ▶ Steak Knife, 33 x 2 x 1.5cm	1 ea / 12 ea
o.	11640 ▶ Tong, 16 x 4.5 x 2cm (*18/8)	1 ea / 12 ea
p.	11641 ▶ Tong, 23 x 7 x 3.5cm (*18/8)	1 ea / 12 ea
q.	11642 ▶ Tong, 29 x 8.5 x 4.5cm (*18/8)	1 ea / 12 ea



A PERFECT **BALANCE** BETWEEN **VERSATILITY** AND SIMPLE **BEAUTY.**

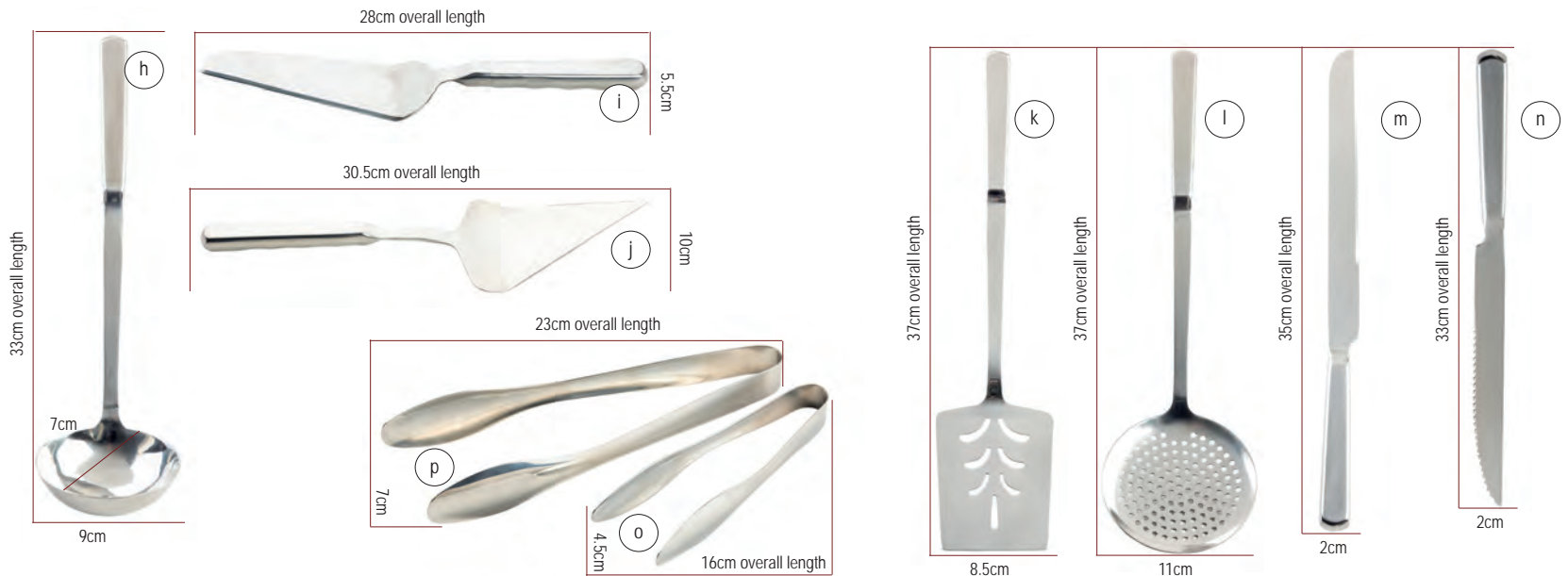

GO AHEAD... BE PICKY!

In fact, we encourage it. Whether it's for a special occasion or to help identify ham and swiss from turkey and provolone, our eco-friendly, disposable picks are a welcomed accessory to any buffet, banquet or catering function. For sanitary reasons, single use only.



BAMBOO PICKS

Item #	Description	Min Order/ Case Pack
FORK PICKS (100 PER POLYBAG)		
a. BAMF35	9cm Fork Pick	12 pk
CARD HOLDER PICKS (100 PER POLYBAG)		
b. BAML35	9cm Card Holder	12 pk
BAML7	17.5cm Card Holder	12 pk
SPORTS PICKS (100 PER POLYBAG)		
c. BAMSP145	11.5cm Baseball Sport	12 pk
d. BAMSP245	11.5cm Basketball Sport	12 pk
e. BAMSP345	11.5cm Golf Tees (Assorted Colors)	12 pk
f. BAMSP545	11.5cm Football Sport	12 pk
g. BAMSP645	11.5cm American Football Sport	12 pk

Item #	Description	Min Order/ Case Pack
KNOT PICK (100 PER POLYBAG)		
h. BAMK35	9cm Knot	12 pk
BAMK45	11.5cm Knot	12 pk
BAMK7	18cm Knot	12 pk
LOOPED & HEART LOOPED PICKS (100 PER POLYBAG)		
i. BAML45	11.5cm Looped	12 pk
j. BAMH45	11.5cm Heart Looped	12 pk
BAMH6	15cm Heart Looped	12 pk
CHALKBOARD PICKS (100 PER BOX)		
k. BAMDCB35	9cm Chalkboard	1 pk / 12 pk



...ADD
SOME
FLARE



BAMBOO PICKS



Item #	Description	Min Order/ Case Pack
PADDLE PICKS, STEAK MARKERS (100 PER POLYBAG)		
a	RARE 9cm "Rare" Paddle Pick	12 pk
b	MEDRARE 9cm "Medium Rare" Paddle Pick	12 pk
c	MEDIUM 9cm "Medium" Paddle Pick	12 pk
d	MEDWELL 9cm "Medium Well" Paddle Pick	12 pk
e	WELLDONE 9cm "Well Done" Paddle Pick	12 pk
FRENCH PADDLE PICKS, STEAK MARKERS (100 PER POLYBAG)		
f	A POINT 9cm "A Point" Paddle Pick	1 pk / 12 pk
g	BIEN CUIT 9cm "Bien Cuit" Paddle Pick	1 pk / 12 pk
h	BLEU 9cm "Bleu" Paddle Pick	1 pk / 12 pk
i	SAIGNANT 9cm "Saignant" Paddle Pick	1 pk / 12 pk
VEGAN PADDLE PICKS (50 PER POLYBAG)		
j	BAMP45VG 11.5cm Vegan Paddle Pick	12 pk

Item #	Description	Min Order/ Case Pack
SWORD PICKS (50 PER BOX)		
k.	BAMP35 11.5cm Sword Pick	12 pk
	BAMP36 15cm Sword Pick	12 pk
PADDLE PICK (100 PER POLYBAG)		
l.	BAMP35 9cm Paddle	12 pk
	BAMP45 11.5cm Paddle	12 pk
	BAMP7 18cm Paddle	12 pk
PADDLE PICKS, ALLERGY & GLUTEN FREE (100 PER POLYBAG)		
	BAMP35A 9cm Allergy Paddle	12 pk
m.	BAMP45A 11.5cm Allergy Paddle	12 pk
n.	BAMP35G 9cm Gluten-Free Paddle	12 pk
	BAMP5G 13cm Gluten-Free Paddle	12 pk
PURPLE PADDLE PICKS (100 PER POLYBAG)		
o.	BAMP45PR 11.5cm Purple Paddle	12 pk

HOLDERS FROM CONES TO CARDS



DISPOSABLE CUPS, CONES AND BOATS

- A refreshing way to present appetisers, desserts and samples
- Easy to serve and comfortable for guests to hold



Item #	Description	Capacity	Min Order/ Case Pack
CONES, PINEWOOD (50 PER BOX)			
BAMDCN5	Mini, 5 x 5.5 x 12.5cm	45ml	12 pk
BAMDCN6	Small, 6.5 x 7 x 15cm	90ml	12 pk
a. BAMDCN7	Large, 7.5 x 9 x 18cm	140ml	12 pk
CUPS, PINEWOOD (50 PER BOX)			
BAMDCP2	Small, 6cm dia x 6cm	120ml	12 pk
b. BAMDCP1	Mini, 4.5cm dia x 4.5cm	60ml	12 pk
BOATS, PINEWOOD (50 PER BOX)			
c. BAMDB3	Mini, 8.5 x 5.5 x 2.5cm	30ml	12 pk
BAMDB45	Small, 11.5 x 6.5 x 3cm	45ml	12 pk
d. BAMDB5	Medium, 13.5 x 8.5 x 4cm	90ml	12 pk
BAMDB65	Large, 16.5 x 9 x 4cm	150ml	12 pk
BAMDB8	Extra Large, 19.5 x 9.5 x 4.5cm	235ml	12 pk



b

- Disposable
- Single-use
- Eco-friendly



c



a



d

DISPOSABLE CONE HOLDERS

- Display your disposable cones in style with our selection of tiered cone holders
- All styles include handles for easy transportation to and from the serving line



Item	Description	Min Order/ Case Pack
a. DCH27	Chrome Plated Metal, Holds 27 Cones, 18.5cm dia x 42cm	1 ea / 6 ea
b. DCH01	Black Powder Coated Metal, Holds 1 Cone, 5.5 x 6.5 x 10 cm	1 ea / 12 ea



CARD HOLDERS



Item #	Description	Min Order/ Case Pack
BLACK POWDER COATED METAL		
c.	BKC2202 5cm dia, Stand with Clip	1 ea / 12 ea
	BKC2206 5cm dia x 15cm, Stand with Clip	1 ea / 12 ea
d.	BKC2208 5.5cm dia x 20.5cm, Stand with Clip	1 ea / 12 ea
	BKC2212 5.5cm dia x 30.5cm, Stand with Clip	1 ea / 12 ea
STAINLESS STEEL – PLASTIC		
e.	CH2 5 x 5 x 9 cm, Circle Clip, Stainless Steel	1 ea / 12 ea
f.	CH5 2.5 x 2.5 x 11.5cm, Cube with Clip, Clear Plastic	1 ea / 12 ea
g.	CHX4 1 x 1.5 x 11.5cm, Double-sided Clip, Stainless Steel	1 ea / 12 ea
STAINLESS STEEL		
h.	2504 5 x 5 x 10cm Harp Clip	1 ea / 6 ea
	2508 6.5 x 6.5 x 20cm Harp Clip	1 ea / 6 ea
	2512 7.5 x 7.5 x 30.5cm Harp Clip	1 ea / 6 ea
i.	797 2 x 2 x 4cm Harp Clip	12 ea / 120 ea
HAMMERED TEXTURE STAINLESS STEEL		
j.	11575 5 x 5 x 3.5cm Card Holder, Stainless Steel	1 ea / 24 ea
k.	11576 5 x 5 x 3.5cm Card Holder, Gold PVD	1 ea / 24 ea
l.	11577 5 x 5 x 3.5cm Card Holder, Black Powder Coating	1 ea / 24 ea





REFRESHING BEVERAGE OPPORTUNITIES

TableCraft has a variety of solutions to fit your beverage dispensing needs. Our high quality dispensing options are designed to keep beverage stations organised and your operation moving.

COLD BEVERAGE DISPENSERS | 42

Upscale Beverage Dispensers 42
 Silhouette™ Beverage Dispensers..... 42
 Dual Beverage Dispensers..... 43
 Plastic Stackable Dispenser 43
 Slimline Beverage Dispensers..... 43
 Clear Glass Beverage Dispensers 44-45
 Glass Beverage Dispenser Stands..... 46
 Glass Beverage Dispenser Accessories..... 46
 Touchless Faucets..... 46

COLD BEVERAGE ACCESSORIES & TUBS | 47

Single Wall Beverage Tubs 47
 Bali Collection™ Beverage Tubs 47
 Remington Collection™ Beverage Tubs..... 47
 Brickhouse Collection™ Single Wall..... 47
 Double Wall Beverage Tubs 47

COLD BEVERAGE PITCHERS & ACCESSORIES | 48

Resealable Water Carafes 48
 Premium Water Servers 49
 Beverage Pitchers 49
 Tea Infuser..... 50
 Measuring Spoons..... 50
 Frothing Cups..... 51
 Bell Creamer..... 51
 Malt Cup 51
 Straw Dispensers 51



Port-A-Party: Beverage Tubs for Every Day Use, Every Where You Need Them. See page 35.



Scan code or go to our YouTube channel to watch our touchless faucet video

INFUSIBLES ARE UNREFUSABLE

More serving options and opportunities from chilled to flavored beverages in our Upscale, Silhouette™ and Stackable plastic beverage dispensers. Assorted styles available in multiple capacities for small to large groups.

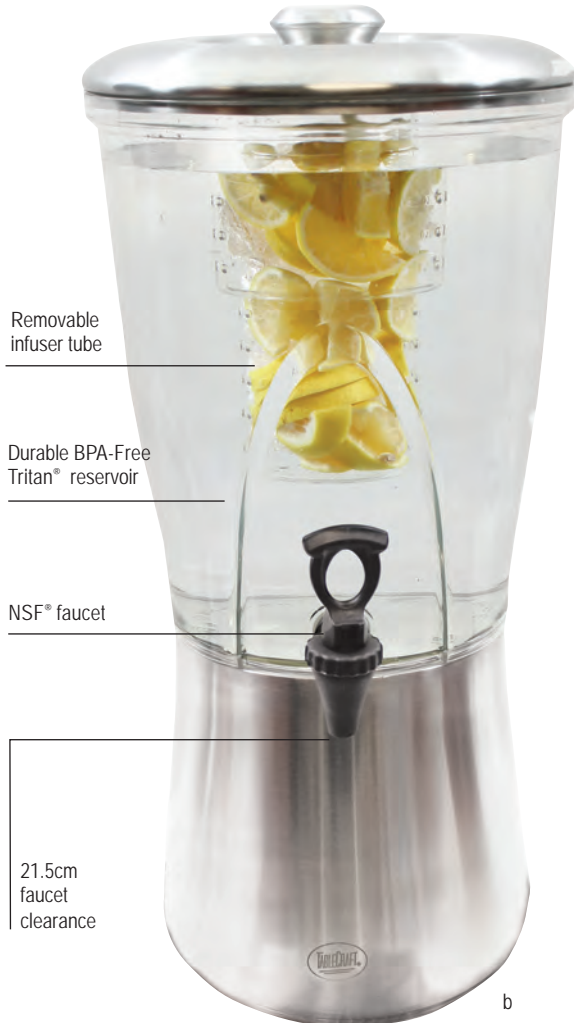

Removable infuser tube

Durable BPA-Free Tritan® reservoir

NSF® faucet

21.5cm faucet clearance

SILHOUETTE™
BEVERAGE DISPENSER



Hands free faucet option available (10626) see page 46

18cm faucet clearance on item 85



18.9 L capacity

Other capacities available

Durable BPA-Free Tritan® Reservoir

Removable infuser (75IC)

Removable ice core (75T)

Removable ice core tube fits into removable infuser

Item #	Description	Capacity	Min Order/ Case Pack
UPSCALE BEVERAGE DISPENSERS—STAINLESS STEEL, BPA-FREE TRITAN® PLASTIC			
*75	Upscale Beverage Dispenser, 17cm faucet clearance, 27.5 x 27.5 x 49.5cm	11.4 L	1 ea / 2 ea
a. *85	Upscale Beverage Dispenser, 18cm faucet Clearance, 31 x 33.5 x 62cm	18.9 L	1 ea
SILHOUETTE™ BEVERAGE DISPENSERS –STAINLESS STEEL, BPA-FREE TRITAN® PLASTIC			
b. *N175	NSF® Single, 21.5cm Faucet Clearance, 28.5 x 28.5 x 59.5cm	13.2 L	1 ea
REPLACEMENT PARTS & ACCESSORIES (MOST DISPENSERS)			
75FM	Universal Stainless Steel Faucet, Fits 75, 85, 7515, BDG1000, BDG2000, BDG3000, 123494, 123495 and 123496	-	1 ea / 100 ea
BDGF	Chrome Plated ABS Faucet for BAD1500 and BDG Glass Beverage Dispensers	-	1 ea / 120 ea
75F	Heavy Duty Nickel Plated ABS Faucet for 75, 85	-	1 ea / 200 ea
N175F	NSF® Polypropylene Faucet for N175	-	1 ea / 200 ea

DUAL BEVERAGE OPTIONS



a



b



c

DUAL

- Perfect addition to your breakfast buffet
- A simple way to offer a variety of drinks
- Includes a removable reservoir with built-in drainable ice chamber to keep drinks cool



STACKABLE*

- Stackable design, ideal solution for serving a variety of drinks on even a smaller serving station
- Compact and lightweight, perfect for smaller spaces
- Includes a removable infuser tube
- Sold individually



SLIMLINE BEVERAGE DISPENSER

- Detachable reservoirs and quality Tomlinson® faucets
- Simple to clean, easy to refill and quick to serve.
- Graduated measurements displayed on the side of reservoir for efficient and consistent filling.



e



d

Item #	Description	Capacity	Min Order/ Case Pack
DUAL BEVERAGE DISPENSERS			
a. 70	Double, 14cm faucet clearance, 30.5 x 35 x 58.5cm	(2) 5.7 L	1 ea
PLASTIC STACKABLE BEVERAGE DISPENSERS			
b. *BAD1500	BPA Free Dispenser with Infuser, 12cm faucet clearance, 24 x 24 x 34cm	5.7 L	1 ea / 4 ea
SLIMLINE BPA-FREE POLYPROPYLENE BEVERAGE DISPENSERS			
c. 353DP	Single, Black, 21cm faucet clearance, 20.5 x 41 x 52.5cm	11.4 L	1 ea
REPLACEMENT PARTS & ACCESSORIES			
d. 70F	Faucet for 70	-	1 ea
e. 852F	Heavy Duty Tomlinson® Faucet Assembly for 353DP	-	1 ea / 100 ea



Citrus
Infused
Water

Chalkboard
Necklace
(BDCHBD)

Choose from four styles; Beehive™, Rustic Country™, Mason Jar (2 sizes) and Industrial Collection™ — mix and match with our raised galvanized bases or a variety of wire bases to fit the style of your presentation (see page 46).

Each dispenser brings character and charm to your drink station.

All include a chalkboard necklace (BDCHBD - shown above) for labelling your drinks.

GET READY TO FILL, CHILL AND THRILL



a/d



b/e



c/f



g



h

BEVERAGE DISPENSERS *

CLEAR GLASS

Item #	Description	Capacity	Min Order/ Case Pack
CLEAR GLASS BEVERAGE DISPENSERS (ALL INCLUDE x1 CHALKBOARD NECKLACE – BDCHBD)			
a.	*BDG1000 Beehive™ with Chrome Plated Plastic Tap, Ice Core and Infuser, 23 x 27.5 x 37cm	9.5 L	1 ea
b.	*BDG2000 Rustic Country™ with Chrome Plated Plastic Tap, Resealable Lid, 21 x 26.5 x 35.5cm	8.5 L	1 ea
c.	*BDG3000 Mason Jar with Chrome Plated Plastic Tap, Ice Core and Infuser, 19.5 x 26 x 32cm	8 L	1 ea
d.	123494 Beehive™ with Stainless Steel Tap, Ice Core and Infuser, 23 x 27.5 x 37cm	9.5 L	1 ea
e.	123495 Rustic Country™ Resealable Lid with Stainless Steel Tap, 21 x 26.5 x 35.5cm	8.5 L	1 ea
f.	123496 Mason Jar with Stainless Steel Tap, Ice Core and Infuser, 19.5 x 26 x 32cm	8 L	1 ea
g.	*10090 Industrial Collection™ with Chrome Plated Plastic Tap, Ice Core and Infuser, 20.5 x 25.5 x 32.5cm	9 L	1 ea
h.	*10360 Mini Mason Jar with Chrome Plated Plastic Tap, Ice Core and Infuser, 18 x 18 x 31cm	5.5 L	1 ea
REPLACEMENT FAUCETS			
i.	BDGF Faucet for BAD1500, BDG1000, BDG2000, and BDG3000, Chrome Plated Plastic	-	1 ea
j.	123497 Faucet for All Beverage Dispensers, Stainless Steel	-	1 ea / 48 ea



STAND AND DELIVER

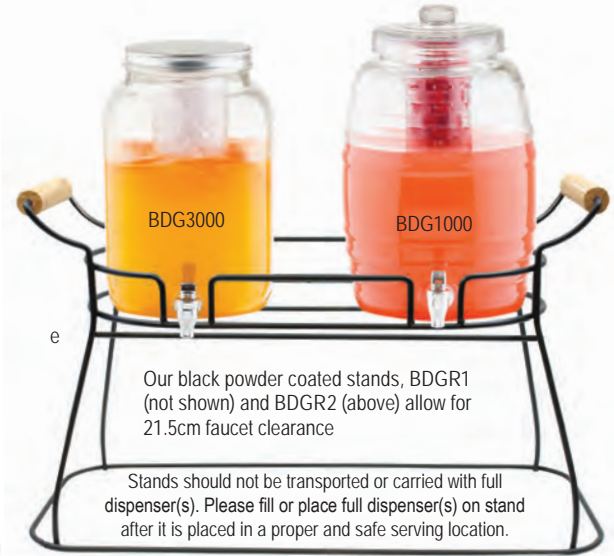
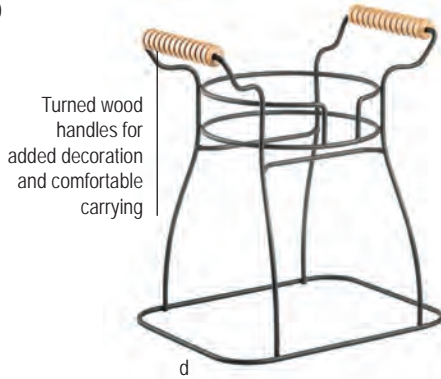

STANDS & ACCESSORIES

Elevate your beverage service! Our stands fit our range of Glass Beverage Dispensers and are available in many options to match with our existing buffet risers, crates and platters to create a consistent look on the serving presentation.

- Do not submerge in water, wipe with a damp cloth and dry immediately

TOUCHLESS FAUCETS



- Our new touchless faucets provide sanitary, no contact dispensing to keep your employees, customers and operation safe and clean
- Simple, push designs are convenient, clean and easy to use
- Great for self-serve



Faucet:	Fits Dispenser(s):
10626	75, BDG1000, BDG2000, BDG3000, 123494, 123495, 123496, 10360, BAD1500, 10090, 353DP & 356DP
70F	70

Item #	Description	Min Order/ Case Pack
ACCESSORIES & REPLACEMENTS PARTS		
a.	BDCHBD Chalkboard Necklace Fits All Glass Beverage Dispensers, 10 x 0.1 x 7.5cm	1 ea / 48 ea
b.	BDGF Faucet for BAD1500, BDG1000, BDG2000, & BDG3000, Chrome Plated Plastic	1 ea / 120 ea
c.	BDGTUB Round Beverage Tub, Galvanised Steel, 24cm dia x 19.5cm	1 ea / 6 ea
	BDGR1 Single Wire Beverage Dispenser Base, Black Powder Coated, (21.5cm faucet clearance)	1 ea / 6 ea
d.	10361 Beverage Stand for Mini Mason Jar 10360 Beverage Dispenser (21.5cm faucet clearance)	1 ea / 6 ea
e.	BDGR2 Double Wire Beverage Dispenser Base, Black Powder Coated, (21.5cm faucet clearance)	1 ea / 6 ea
f.	10262 Industrial Collection™ Dispenser Base, Black Powder Coated, (Fits 10090 and BDG2000)	1 ea
	10173 Faucet for 10090, Black Plated Plastic	1 ea / 120 ea
TOUCHLESS FAUCETS		
g.	10626 Universal Faucet, Black	1 ea / 200 ea
h.	70F Faucet with Chrome Plated Metal	1 ea

For full product dimensions see our website.



BEVERAGE TUBS

SINGLE OR DOUBLE WALL

Item #	Description	Capacity	Min Order/ Case Pack
SINGLE WALL BEVERAGE TUBS – GALVANISED			
a.	BDGTUB Round, 24cm dia x 19.5cm	5.5 L	1 ea / 6 ea
b.	BT1914 Oval, 58 x 37 x 24cm	21 L	1 ea
c.	HBT1914 Oval, 58 x 37 x 24cm (bulk pack)	21 L	6 ea
d.	GT2313 Oval, Pebbled Texture, 58 x 31 x 19cm	16.8 L	1 ea
BEVERAGE TUBS – STAINLESS STEEL			
e.	Bali Collection™ Single Wall Oval Tub, 52 x 33.5 x 22cm	15.1 L	1 ea
f.	Remington Collection™ Double Wall Tub with Base, Rice Pattern, 42cm dia x 24cm	28.4 L	1 ea
BEVERAGE TUB SETS – STAINLESS STEEL			
g.	GTSS2313N Brickhouse Collection™ Set includes Tub, Stand, Accessory, Condensation Tray (Overall 70 x 38 x 81.5cm)	48.3 L	1 ea
h.	BT2137N Double Wall Tub Set includes & Black Powder Coat Stand, (Overall 51cm dia x 95.5cm)	41.4 L	1 ea
REPLACEMENT PARTS & ACCESSORIES			
GTSS2313	Beverage Tub for GTSS2313N Set, 58 x 31 x 19cm	48.3 L	1 ea
GTSS2313CT	Condensation Tray for GTSS2313N Set, 60.5 x 32.5 x 5cm	-	1 ea / 12 ea
GTSS2313AT	Accessory Tray for GTSS2313N Set, 63 x 32 x 5.5cm	-	1 ea / 12 ea
GTSS2313S	Beverage Tub Stand for GTSS2313N Set, 59.5 x 32.5 x 57cm	-	1 ea / 4 ea



From single to double walled, and tabletop to floor standing, Our unique collection of beverage tubs are available in a variety of shapes, sizes and styles for any occasion.

**REFRESH,
REUSE
AND
REPEAT**



Silicone seal
and snap-lock
closures for safe
storage and
transport



RESEALABLE GLASS CARAFES

Upscale your beverage service again and again.



Item #	Description	Capacity	Min Order/ Case Pack
RESEALABLE WATER SERVERS - GLASS			
a.	*RSB33 Bottle with Silicone Seal, 8.5 x 8.5 x 32 cm	1 L	12 ea
b.	*RGC34 Bottle with Silicone Seal, 11 x 9 x 27cm	1 L	6 ea



COLD BEVERAGE PITCHERS

Item #	Description	Capacity	Min Order/ Case Pack
PREMIUM WATER SERVERS – 18/8 STAINLESS STEEL, MIRROR FINISH			
a. 300	Pitcher, Ice Guard, 22 x 12.5 x 21.5cm	2 L	1 ea / 12 ea
b. RP68	Remington Collection™ Pitcher w/ Base, Ice Guard, Rice Pattern, 20.5 x 14.5 x 21.5 cm	2 L	1 ea / 12 ea
BEVERAGE PITCHERS – SAN PLASTIC, CLEAR			
c. 364	Clear Pitcher, 18 x 12.5 x 20.5cm	1.8 L	1 ea / 12 ea
d. PP321	Pitcher with Lid, 18 x 11.5 x 25 cm	2 L	1 ea / 12 ea



PREMIUM SERVERS



Highly polished
Stainless Steel

BEVERAGE PITCHERS



BPA
FREE



Lid features
free flow and
ice guard

YOUR SPOT FOR TEA

TEA INFUSER

Our new stainless steel tea infuser is perfect for your morning or afternoon tea. It keeps all your loose-leaf tea inside the filter infusing your tea into your water. The bent handle is perfect to aid filling with loose tea leaves. Simple action allows zero contamination of tea leaves with hands.

- Stainless Steel construction
- Easy to clean, dishwasher safe



MEASURING SPOONS

Great for coffee service and precise portion control.



a

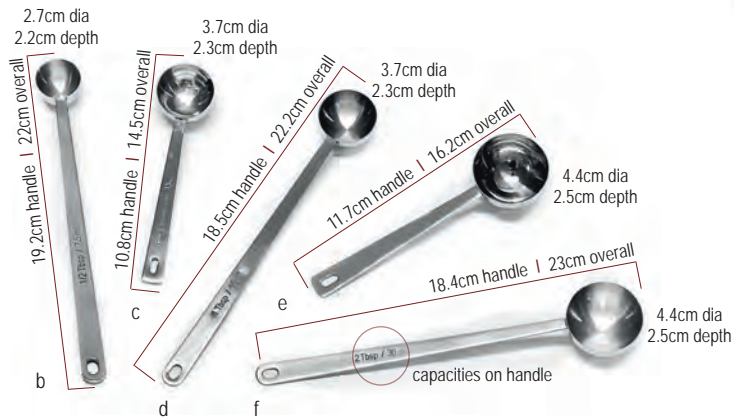

Item #	Description	Capacity	Min Order/ Case Pack
TEA INFUSER – (18-8) STAINLESS STEEL			
a. 11758 ▶	Tea Infuser 15 x 2 x 2cm Stainless Steel for Loose Tea Leaves	-	1 ea / 6 ea
MEASURING SPOONS – STAINLESS STEEL			
b. 40400	½ tbsp Long Handled Scoop, 22 x 2.5 x 2cm	7.5 ml	1 ea / 12 ea
c. 401	1 tbsp Scoop, 14.5 x 3.5 x 2cm	15 ml	1 ea / 12 ea
d. 40401	1 tbsp Long Handled Scoop, 22 x 3.5 x 2.5cm	15 ml	1 ea / 12 ea
e. 402	2 tbsp Scoop, 16 x 4.5 x 2.5cm	30 ml	1 ea / 12 ea
f. 40402	2 tbsp Long Handled Scoop, 23 x 4.5 x 2.5cm	30 ml	1 ea / 12 ea

PREPARE AND PRESENT

FROTHING CUPS



Handled cups for your barista stand

Essential tool for frothing milk for lattes, cappuccinos, and more



BELL CREAMER



d

MALT CUP



- Great for malts and shakes
- Fits most standard mixers



e

STRAW DISPENSERS

- Stainless Steel and fluted glass options



f



g

Item #	Description	Capacity	Min Order/ Case Pack
FROTHING CUPS – STAINLESS STEEL			
a.	*2014 12-14oz Cup, 11 x 8 x 9cm	415 ml	1 ea / 12 ea
b.	2024 20-24oz Cup, 14 x 8 x 10cm	710 ml	1 ea / 12 ea
c.	2036 32-36oz Cup, 15 x 10.5 x 12.5cm	1.1 L	1 ea / 12 ea
BELL CREAMER – STAINLESS STEEL			
d.	2303 Creamer, 8 x 4.5 x 6cm	90ml	1 ea / 12 ea
MALT CUP – STAINLESS STEEL			
e.	*64E Malt Cup 10.5cm dia x 18cm	890 ml	1 ea / 12 ea
STRAW DISPENSERS			
f.	237 Two-Sided Straw Dispenser, Stainless Steel, 24.5 x 18 x 18.5cm (Holds up to 500 individually wrapped straws - not included)		1 ea / 8 ea
g.	*H714CH Glass Straw Dispenser, Chrome Plated Insert, 11cm dia x 28.5cm (Straws not included)		6 ea / 6 ea

MEASURE, MIX & POUR

We offer professional, well-designed essentials for any bar or restaurant. From bartending tools, bar equipment and supplies, to providing wine service and bar accessories, TableCraft's products tend to the bar so you can tend to your customers.



BARTENDING TOOLS | 54

Waverly Collection™ Mixing Glasses	54
PVD Barware Collections	55
Black Floral Finish Barware	56
Champagne Finish Barware	57
Premium Barware Collections	58
Premium Brushed Finish Barware	59
Pourmaster® One-Piece Neck/Spout	60
Pourmaster® Backups	60
Pourmaster® Series	61
Pourmaster® Completes	61
Measured Pourers	62
Proper Pour® III Measured Pourers	62
Free Flow Pourers	62
Whiskey Pourers	62
Economy Pourers	62
Screen Em™ Pourers	62
Pourer Covers	62
Japanese Style Jiggers	63
Classic Style Jiggers	63
3-Piece Bar Shakers	63
Bar Shaker Cups	63
Bar Strainers	63
Muddlers	63
Citrus Squeezers	64
Firmgrip™ Paring Knives	64
Bar Spoons	64
Pom Tongs	64
Bottle Openers	64
Glass Rimmers	65
Ice Scoops	66
Pitcher	66
Bar Mats and Mesh Liner	67
Single Speed Rails	67
Double Speed Rails	67

BAR SUPPLIES & EQUIPMENT | 68

Ultimate Garnish Station	68
First In, First Out Garnish Station	69
Condiment Dispensers	69-70

BEER & WINE ACCESSORIES | 71

Paddle Flights	71
Wine Flights	71
Glass Hangers	71
Ice Buckets & Wine Servers	72
Wine/Champagne Serving Tools	72
2-Piece Windproof Ashtrays	72
Classic Stacking Deepwell Ashtrays	72
Economy Stacking Deepwell Ashtrays	72
Champagne/Wine Buckets & Stand	73



View a video on all the benefits of our 4 Swing Out Trays Glass Rimmer



View a video on crafting the perfect Mojito





WAVERLY COLLECTION™ MIXING GLASSES

Upgrade your bar assortment with our mixing glasses that come in three different designs. These are great for mixing cocktails in style.

- Easy to clean, dishwasher safe



Scan code to view a video on our Waverly Collection™



Item	Description	Capacity	Min Order/ Case Pack
MIXING GLASSES - CLEAR			
a.	11699 ▶ Starburst Pattern, 10.5 x 9.5 x 14.5cm	700ml	1 ea / 6 ea
b.	11698 ▶ Vertical Pattern, 10.5 x 9.5 x 14.5cm	700ml	1 ea / 6 ea
c.	11697 ▶ Diamond Cut Pattern, 10.5 x 9.5 x 14.5cm	700ml	1 ea / 6 ea



PVD BARWARE

Refresh your bar assortment with our new PVD barware available in gold, bronze, and gunmetal. We have all the necessary tools to make cocktails in style.

- Stainless Steel with a PVD matte finish
- Easy to clean, dishwasher safe
- Conveniently packaged for cash & carry



NEW

Item #	Description	Capacity	Min Order/ Case Pack
18/8 STAINLESS STEEL, GOLD			
a.	11867 ▶ 2-Piece Can-on-Can Boston Shaker, 9cm dia x 17cm	530ml	1 ea / 6 ea
b.	11814 ▶ Muddler with Plastic Head, 3.5cm dia x 20.5cm	-	1 ea / 6 ea
c.	11815 ▶ 2-Prong Strainer, 14.5 x 9 x 2cm	-	1 ea / 6 ea
d.	11816 ▶ Bar Spoon, 3 x 2 x 27.5cm	-	1 ea / 6 ea
e.	11817 ▶ Jigger, 4cm dia x 6.5cm	15ml / 30ml	1 ea / 6 ea
18/8 STAINLESS STEEL, BRONZE			
f.	11868 ▶ 2-Piece Can-on-Can Boston Shaker, 9cm dia x 17cm	530ml	1 ea / 6 ea
g.	11819 ▶ Muddler with Plastic Head, 3.5cm dia x 20.5cm	-	1 ea / 6 ea
h.	11820 ▶ 2-Prong Strainer, 14.5 x 9 x 2cm	-	1 ea / 6 ea
i.	11821 ▶ Bar Spoon, 3 x 2 x 27.5cm	-	1 ea / 6 ea
j.	11822 ▶ Jigger, 4cm dia x 6.5cm	15ml / 30ml	1 ea / 6 ea
18/8 STAINLESS STEEL, GUNMETAL			
k.	11869 ▶ 2-Piece Can-on-Can Boston Shaker, 9cm dia x 17cm	530ml	1 ea / 6 ea
l.	11824 ▶ Muddler with Plastic Head, 3.5cm dia x 20.5cm	-	1 ea / 6 ea
m.	11825 ▶ 2-Prong Strainer, 14.5 x 9 x 2cm	-	1 ea / 6 ea
n.	11826 ▶ Bar Spoon, 3 x 2 x 27.5cm	-	1 ea / 6 ea
o.	11827 ▶ Jigger, 4cm dia x 6.5cm	15ml / 30 ml	1 ea / 6 ea



BLACK FLORAL PATTERN STAINLESS STEEL BARWARE



	Item #	Description	Capacity	Min Order/ Case Pack
a.	10778	24oz Boston Can, 8.5cm dia x 16.5cm (Fits 10780)	710 ml	1 ea / 6 ea
b.	10779	16oz Mini Boston Can, 8.5cm dia x 12.5cm	470 ml	1 ea / 12 ea
c.	10780	28oz Can-on-Can Boston Shaker, 9.5cm dia x 17.5cm (fits 10778)	830 ml	1 ea / 12 ea
d.	10781	4-Prong Strainer, 12 x 2.5 x 15cm	-	1 ea / 12 ea
e.	10784	Bar Spoon with Muddler, 4 x 2 x 31.5cm	-	1 ea / 24 ea
f.	10785	Bar Tongs, 5.5 x 2 x 17.5cm	-	1 ea / 12 ea
g.	10786	Flat Bottle Opener, 18 x 4 x 0.2cm	-	1 ea / 12 ea
h.	10787	1oz & 2oz Jigger, 5cm dia x 12.5cm	30/60ml	1 ea / 6 ea



CHAMPAGNE FINISH STAINLESS STEEL BARWARE

	Item #	Description	Capacity	Min Order/ Case Pack
a.	10788	24oz Boston Can, 8.5cm dia x 16.5cm (Fits 10790)	710 ml	1 ea / 6 ea
b.	10789	16oz Mini Boston Can, 8.5cm dia x 12.5cm	470 ml	1 ea / 12 ea
c.	10790	28oz Can-on-Can Boston Shaker, 9.5cm dia x 17.5cm (fits 10788)	830 ml	1 ea / 12 ea
d.	10791	4-Prong Strainer, 12 x 2.5 x 15cm	-	1 ea / 12 ea
e.	10794	Bar Spoon with Muddler, 4 x 2 x 31.5cm	-	1 ea / 24 ea
f.	10795	Bar Tongs, 5.5 x 2 x 17.5cm	-	1 ea / 12 ea
g.	10796	Flat Bottle Opener, 18 x 4 x 0.2cm	-	1 ea / 12 ea
h.	10797	1oz & 2oz Jigger, 5cm dia x 12.5cm	30/60ml	1 ea / 6 ea

HEY BARTENDER... ARE YOU READY FOR A REFRESH?

PREMIUM BARWARE IN BLACK ACID ETCH FINISH

Our new barware ranges feature all the essential tools for bartenders while upgrading the look of your bar service.

- Available in Black PVD with our unique Random Acid Etching finish
- Easy to clean, dishwasher safe



18-8 STAINLESS STEEL, BLACK PVD WITH RANDOM ACID ETCH FINISH

Item #	Description	Capacity	Min Order/ Case Pack
a.	10904 2-Piece Cocktail Shaker, 9.5cm dia x 23.5cm	590 ml	1 ea / 6 ea
b.	10552 3-Piece Cocktail Shaker, 8.5cm dia x 20cm	530 ml	1 ea / 6 ea
c.	10553 3-Piece Cocktail Shaker, 9.5cm dia x 25cm	700 ml	1 ea / 6 ea
d.	10554 Boston Can, 8cm dia x 12.5cm	530 ml	1 ea / 6 ea
e.	10555 Boston Can, 9cm dia x 17.5cm	825 ml	1 ea / 6 ea
f.	10556 4-Prong Strainer, 9cm dia, 12cm dia Prongs	-	1 ea / 6 ea
g.	10557 Julep Strainer, 8cm dia with 7cm Handle	-	1 ea / 6 ea
h.	10558 Bar Spoon, 30cm	-	1 ea / 6 ea
i.	10559 Muddler with Plastic Head, 21cm	-	1 ea / 6 ea
j.	10560 ½oz / 1oz Japanese Jigger, 4cm dia x 7.5cm	15 / 30ml	1 ea / 6 ea
k.	10561 1oz / 1½oz Japanese Jigger, 4.5cm dia x 11cm	30 / 45ml	1 ea / 6 ea
l.	10562 1oz / 2oz Japanese Jigger, 4.5cm dia x 12cm	30 / 60ml	1 ea / 6 ea

PREMIUM BARWARE IN BRUSHED FINISH

Upscale barware constructed of durable 18-8 Stainless Steel with elegantly neutral finishes. Our new barware ranges feature all the essential tools for bartenders while upgrading the look of your bar service.

- Available in neutral brushed Stainless Steel finish
- Easy to clean, dishwasher safe



18-8 STAINLESS STEEL, BRUSHED FINISH

Item #	Description	Capacity	Min Order/ Case Pack
a.	10520 2-Piece Cocktail Shaker, 9.5cm dia x 23.5cm	590 ml	1 ea / 6 ea
b.	10468 3-Piece Cocktail Shaker, 8.5cm dia x 20cm	530 ml	1 ea / 6 ea
c.	10469 3-Piece Cocktail Shaker, 9.5cm dia x 25cm	700 ml	1 ea / 6 ea
d.	10470 Boston Can, 8cm dia x 12.5cm	530 ml	1 ea / 6 ea
e.	10471 Boston Can, 9cm dia x 17.5cm	825 ml	1 ea / 6 ea
f.	10472 4-Prong Strainer, 9cm dia, 12cm dia Prongs	-	1 ea / 6 ea
g.	10473 Julep Strainer, 8cm dia with 7cm Handle	-	1 ea / 6 ea
h.	10474 Bar Spoon, 30cm	-	1 ea / 6 ea
i.	10475 Muddler with Plastic Head, 21cm	-	1 ea / 6 ea



BAR SOLUTIONS
PREMIUM BARWARE: BLACK ETCHED & BRUSHED



a



b



c



d



e



f



g



h



i

POURMASTER®

ONE-PIECE NECK/SPOUT

- Integrated spout is easier to clean than traditional two-piece neck/spout and; no spout to lose, break or get clogged
- Colour-coded for easy identification and quick selection at busy times
- Better ergonomics with textured step design oval neck than competitors
- Thicker thread, improved design with greater overlap for superior hold and leak protection
- Assorted packs include 2 of each colour
- Necks are cross-compatible—our necks are interchangeable with most competitors' jars



MAKE SURE
TO **BACK**
IT UP

BACKUPS

- Includes container and color-coded cap
- "Assorted" includes 2 of each color for JC1032A
- "Assorted" includes 1 of each color for JC1064A and JC1128A



IT'S ALL ABOUT THE SPOUT

Integrated spout is easier to clean than traditional two-piece neck/spouts

Oval neck with textured step design provides better ergonomics—making gripping, holding, lifting, and pouring safer and easier than the competitors' smooth round design

Features ridges on the base of the neck to give positive grip when tightening or loosening the neck



Thicker thread with improved design and greater overlap for superior hold and leak protection

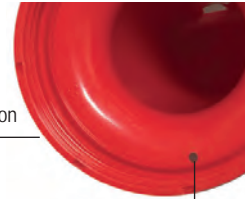

Integrated vent for fast, smooth pours



Packaged for Cash & Carry



Item #	Description	Capacity	Min Order/ Case Pack
POURMASTER® ONE-PIECE NECK/SPOUT COMPLETES – POLYETHYLENE			
a. *10285A	Complete, Assorted Colours	950 ml	12 ea
REPLACEMENT PARTS			
*10286BR	Brown, Neck/Spout Only	–	1 ea / 96 ea
*10286GN	Green, Neck/Spout Only	–	1 ea / 96 ea
b. *10286R	Red, Neck/Spout Only	–	1 ea / 96 ea
*10286W	White, Neck/Spout Only	–	1 ea / 96 ea
*10286X	Orange, Neck/Spout Only	–	1 ea / 96 ea
*10286Y	Yellow, Neck/Spout Only	–	1 ea / 96 ea
POURMASTER® BACKUPS – HIGH DENSITY POLYETHYLENE			
JC1032A	Backup. Includes White Jars with Assorted Coloured Lids	1.0 L	6 ea
c. JC1064A	Backup. Includes White Jars with Assorted Coloured Lids	1.9 L	6 ea
JC1128A	Backup. Includes White Jars with Assorted Coloured Lids	3.8 L	6 ea
REPLACEMENT PARTS & ACCESSORIES			
d. 10217	Pourmaster Replacement Spouts, Set of 3: Orange, Green & Red		1 set

COMPLETES

- Complete set includes: container, easy grip neck with snap-tight colour pourer and a colour-coded cap for easy storage
- Assorted packs include 2 of each colour for 8032A, 1 of each colour for 8064A & 8128A. Also available in single colours. Add colour code to order.



BPA FREE



Item #	Description	Capacity	Min Order/ Case Pack
POURMASTER® – LDPE BOTTLE WITH LONG NECK TOP			
a.	N32A Pourmaster® with Long Neck Top™ Assorted Colours	950 ml	12 ea
POURMASTER® – LDPE BOTTLE WITH LOW PROFILE TOP			
b.	N32LPA Pourmaster® with Low Profile Top™ Assorted Colours	950 ml	12 ea
POURMASTER® COMPLETES – POLYETHYLENE BOTTLE, SAN PLASTIC SPOUT			
c.	8032A Pourmaster® Complete, White Bottle, Assorted Coloured Spouts	950 ml	12 ea
	8032_* Pourmaster® Complete, White Bottle, Colour Cap & Spout (Add colour code to order)	950 ml	12 ea
d.	8032BKBK Pourmaster® Complete, Black Bottle & Cap, Clear Spout	950 ml	12 ea
	8064A Pourmaster® Complete, White Bottle, Assorted Coloured Spouts	2.2 L	6 ea
e.	8064_* Pourmaster® Complete, White Bottle, Colour Cap & Spout (Add colour code to order)	2.2 L	6 ea
f.	8128A Pourmaster® Complete, White Bottle, Assorted Coloured Spouts	3.8 L	6 ea

*Add colour code to order

IT'S THE COMPLETE PACKAGE

FOR CASH & CARRY

Assorted colours include: green (GN), white (WH), orange (X), red (R), yellow (Y) and brown (BR)

EASY TO ORDER, STOCK, STORE AND IDENTIFY



TO ORDER THE COMPLETE ASSORTMENT:
8064 A
item color
number code

TO ORDER A BOTTLE WITH RED POURER:
8064 RD
item color
number code



THE PROPER POUR MEETS THE PERFECT COVER

Accurately pour your craft mixes with reduced over pours, for more consistent drinks that don't rob profits.

- Multi-ball technology ensures accurate measured pours and prevents evaporation
- Proper Pour® III Measured Pourers feature a non-collared pour solution, ideal for cocktail ingredients

POURERS



Provide bartending staff with simple sanitary solutions to keep your service efficient and your customers safe.

FLIP TOP & SCREEN-EM™

Keep liquors free from contaminants



POURER COVERS



Air vent tube ensures smooth and consistent pouring

Item #	Description	Capacity	Min Order/ Case Pack
MEASURED POURERS			
a. *4244A	Black with Blue Dip Tube, 6 x 8mm opening	25 ml	12 ea
PROPER POUR® III POURERS – NON-COLLARED			
b. 146A	Red with Blue Dip Tube, 6 x 8mm opening	25 ml	12 ea / 144 ea
FREE FLOW POURERS – ASSORTED			
c. *330	S/S Tapered Speed Pourer, 5mm opening	-	12 ea / 60 ea
d. *320A	S/S Jet Pourer, 8mm opening	-	12 ea / 60 ea
e. *320C	S/S Hinged Flip Cap Pourer, 8mm opening	-	12 ea / 60 ea
f. *H320C	S/S Hinged Flip Cap Pourer (Pack of 2)	-	1 pk
345	18-8 S/S Pourer, 10mm opening	-	12 ea / 60 ea
g. *597P	S/S Weighted Flip Cap Pourer, 15 x 8mm opening	-	12 ea / 60 ea
h. *598P	S/S Hinged Flip Cap Speed Pourer Spout, Plastic Vent Tube, 15 x 8mm opening	-	12 ea / 60 ea
FREE FLOW WHISKEY POURERS – PLASTIC			
i. 1802	Clear, 6mm opening	-	12 ea / 144 ea
ECONOMY POURERS – CHROME PLATED ABS & PLASTIC			
j. *35R	Red Pourer, 9 x 5mm opening	-	12 ea / 144 ea
k. *35BK	Black Pourer, 9 x 5mm opening	-	12 ea / 144 ea
l. *35G	Green Pourer, 9 x 5mm opening	-	12 ea / 144 ea
m. *35W	White Pourer, 9 x 5mm opening	-	12 ea / 144 ea
SCREEN EM™ POURERS – PLASTIC, SANITARY SCREEN SPOUT			
n. *295X	Smoke Pourer, 8mm opening	-	12 ea / 144 ea
POURER COVERS – PLASTIC††			
o. *DCL	Universal Liquor Pourer Cover, Translucent Clear (12 per pack)	-	1 pk
p. *DCBK	Dust Cap Cover for Liquor Pourers, Opaque Black (12 per pack)	-	1 pk

JIGGERS & SHAKERS

Item #	Description	Capacity	Min Order/ Case Pack
JAPANESE STYLE JIGGERST†			
*JJ1202	½oz & 1oz, 4.5cm dia x 7.5cm	15 & 30 ml	1 ea / 6 ea
a. *JJ1205	1oz & 1½oz, 4.5cm dia x 11cm	30 & 45 ml	1 ea / 6 ea
*JJ1206	1oz & 2oz, 5cm dia x 12.5cm	30 & 60 ml	1 ea / 6 ea
CLASSIC STYLE JIGGERS			
*H1206	1oz & 2oz, 6.5cm dia x 8cm	30 & 60 ml	6 ea
3-PIECE BAR SHAKERS – STAINLESS STEEL			
*375	8oz, 8cm dia x 15cm	265 ml	6 ea
b. *376	16oz, 8cm dia x 19cm	445 ml	6 ea
*377	28oz, 9.5cm dia x 25cm	830 ml	6 ea
BAR SHAKER CUPS – STAINLESS STEEL			
c. 76	16oz, 8cm dia x 12cm	460 ml	12 ea
d. 77	28oz, 9.5cm dia x 17.5cm	870 ml	12 ea
*H77	28oz, 9.5cm dia x 17.5cm	870 ml	6 ea

†Not Government Stamped

BAR TOOLS

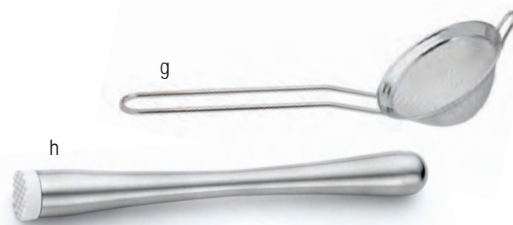

Item #	Description	Min Order/ Case Pack
BAR STRAINERS – STAINLESS STEEL		
e. S209	4 Prong Bar Strainer, 11.5 x 15 x 2cm	1 ea / 12 ea
f. *H211	Premium 2 Prong Strainer, 19 x 9.5 x 2.5cm	6 ea
g. *HS220	Fine Mesh Cocktail Strainer, 7 cm dia with 13cm Handle	12 ea
MUDDLERS – STAINLESS STEEL WITH PLASTIC TIP		
h. *H4258	Muddler, Stainless Steel with Plastic Tip, 2.5cm dia x 22cm	6 ea

JIGGERS JAPANESE & CLASSIC STYLE

- Combo, rolled edge
- 18/8 Stainless Steel
- Capacity stamping in ml & oz



Japanese jiggers have a tall, slender profile compared to the Classic version with a brushed finish and dual (oz/ml) capacity stamping.

*Not government stamped

3-PIECE BAR SHAKERS

- Built-in strainer separates your chilled cocktails from the ice
- Each 3-piece set includes: shaker, lid and built-in strainer



BAR SHAKERS



BAR STRAINERS

CITRUS SQUEEZERS

- Handheld juicing tool, ideal for citrus fruits
- Colour-coded for intended use
- Features a built in draining spout to eliminate seeds



PERFECTGRIP® PARING KNIVES

- A convenient tool that no bar should be without



NEW



Item #	Description	Min Order/ Case Pack
CITRUS SQUEEZERS – COATED ZINC ALLOY OR STAINLESS STEEL		
a. V119	Yellow, Coated Aluminium, 25.5 x 10 x 6cm	1 ea / 6 ea
b. V119GN	Green, Coated Aluminium, 25.5 x 10 x 6cm	1 ea / 6 ea
*H119Y	Yellow, Coated Aluminium, 25.5 x 10 x 6cm	1 ea / 6 ea
c. 95	Lime Squeezer, Stainless Steel, 16 x 10.5 x 3cm	12 ea
PERFECTGRIP® TOOLS		
d. 10973 ▶	Paring Knife, 9cm blade	1 ea / 12 ea
BAR SPOONS – STAINLESS STEEL		
e. *H503K	30.5cm Spoon with Fork	1 ea / 6 ea
f. 501K	28cm Spoon with Red Knob	24 ea
*H501K	28cm Spoon with Red Knob	12 ea

Item #	Description	Min Order/ Case Pack
POM TONGS – STAINLESS STEEL		
g. *H1246	17cm Pom Tongs	6 ea
h. 526T	15cm Pom Tongs	48 ea
BOTTLE OPENERS – STAINLESS STEEL		
j. 396	17.5cm Flat Pocket Opener	1 ea / 36 ea

WITH SUGAR ON TOP

GLASS RIMMERS *



Compact design for easy storage

Our professional 5-Tray Glass Rimmer includes four swing-out trays and one sponge tray to prep cocktail vessels, margarita glasses and shots with an extra special touch.



Item #	Description	Min Order/ Case Pack
GLASS RIMMERS - POLYSTYRENE		
a. *H5633	4 Swing-Out Trays, Black, 16 x 18 x 11cm	1 ea / 4 ea
GLASS RIMMERS - ABS PLASTIC		
b. *H633	3 Swing-Out Trays, Black, 16 x 20 x 7.5cm	4 ea



a

KEEP YOUR
ICE NICE

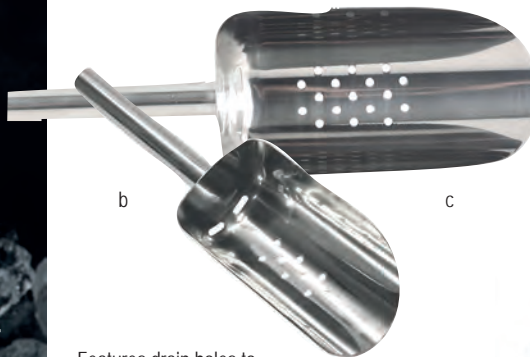

b

c

Features drain holes to prevent melted ice from watering down drinks

ICE SERVICE TOOLS



d

e



Aluminium Scoops are Hand Wash Only



j

i

h

g

f

Durable and lightweight polycarbonate ice scoops

Item #	Description	Capacity	Min Order/ Case Pack
PERFORATED ICE SCOOPS - 18/8 STAINLESS STEEL			

a.	BSC0610	6-10oz Stainless Steel Scoop	170 - 290 ml	1 ea / 12 ea
b.	BSC1216	12-16oz Stainless Steel Scoop	350 - 470 ml	1 ea / 12 ea
c.	BSC2024	20-24oz Stainless Steel Scoop	590 - 710 ml	1 ea / 12 ea

SOLID ICE SCOOPS - STAINLESS STEEL OR ALUMINIUM

d.	512	4oz Stainless Steel Scoop	120 ml	12 ea
e.	605	5oz Aluminium Scoop†	150 ml	1 ea / 12 ea
	612	12oz Aluminium Scoop†	355 ml	1 ea / 12 ea
	624	24oz Aluminium Scoop †	710 ml	1 ea / 12 ea
	638	38oz Aluminium Scoop†	1.1 L	1 ea / 12 ea
	658	58oz Aluminium Scoop †	1.7 L	1 ea / 12 ea
	685	85oz Aluminium Scoop †	2.5 L	1 ea / 12 ea

POLYCARBONATE ICE SCOOPS

f.	11401	6oz Polycarbonate Scoop	180 ml	1 ea / 12 ea
g.	11402	12oz Polycarbonate Scoop	355 ml	1 ea / 12 ea
h.	11403	24oz Polycarbonate Scoop	710 ml	1 ea / 12 ea
i.	11404	32oz Polycarbonate Scoop	950 ml	1 ea / 12 ea
j.	11405	64oz Polycarbonate Scoop	2 L	1 ea / 12 ea

PITCHER

k.	364	Clear Pitcher	1.8 L	1 ea / 12 ea
----	-----	---------------	-------	--------------

† Hand wash only

BEVERAGE PITCHER

Crystal Clear
SAN Plastic

BPA
FREE



j

BAR MATS & MESH LINERS



- A sanitary way to dry and store glassware
- Non-slip, drainable mats for your washing area, shelves or other storage
- Customise any shelf, countertop, sink or cooler with a variety of sizes/styles

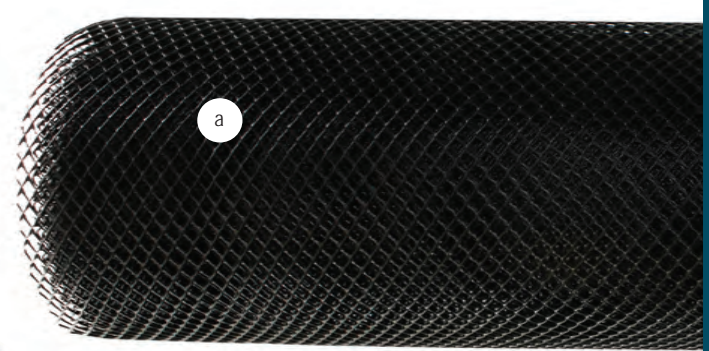

SPEED RAILS

- All speed rails are Stainless Steel
- Universal speed rails have adjustable length
- Single and double speed rails come in 56, 81 or 107cm length

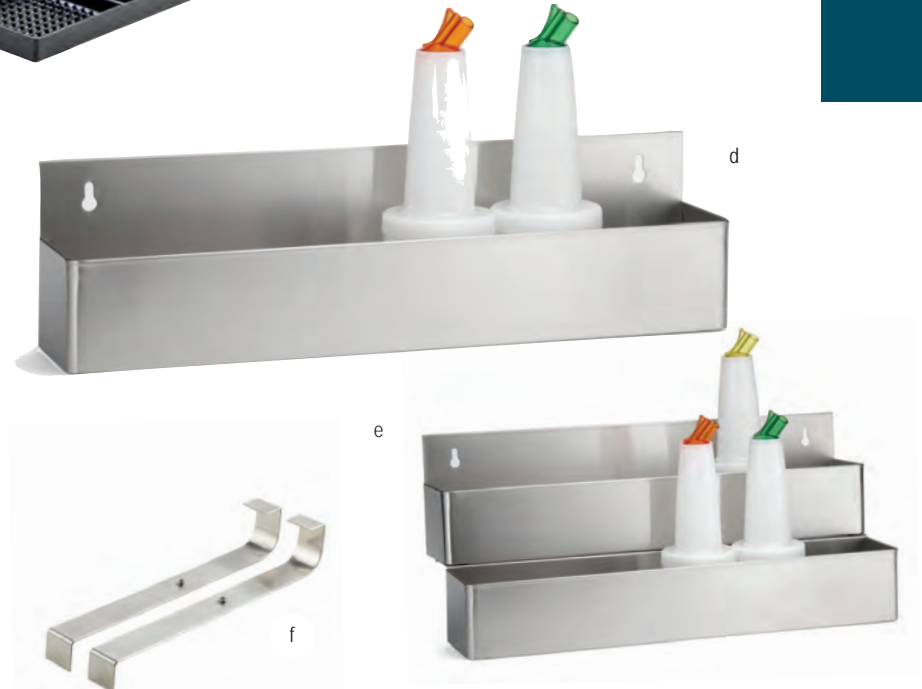

Item #	Description	Min Order/ Case Pack
BAR MATS & MESH LINERS – PLASTIC, RUBBER		
a.	5834 Black Bar Mesh, 12 metre roll	1 ea
b.	1218BK Black Service Mat, 45.5 x 30.5 x 1cm	1 ea / 12 ea
c.	753BK Black Bar Mat, 68.5 x 8 x 1cm	1 ea / 12 ea
SINGLE SPEED RAILS – STAINLESS STEEL		
d.	5122 56 x 10 x 15cm (Holds (5) 950 ml Pourmaster®)	1 ea / 6 ea
	5132 81 x 11.5 x 16cm (Holds (8) 950 ml Pourmaster®)	1 ea / 6 ea
	5142 107 x 10 x 15cm (Holds (11) 950 ml Pourmaster®)	1 ea / 4 ea
DOUBLE SPEED RAILS – STAINLESS STEEL		
e.	5222 56 x 20.5 x 24cm (Holds up to (10) 950 ml Pourmaster®)	1 ea / 3 ea
	5232 81x 20.5 x 25cm (Holds up to (16) 950 ml Pourmaster®)	1 ea / 3 ea
	5242 107 x 21 x 24cm (Holds up to (22) 950 ml Pourmaster®)	1 ea / 3 ea
REPLACEMENT PARTS & ACCESSORIES		
f.	5200 Hanger Straps, Set of 2	1 ea / 100 ea

GARNISH STATIONS

FIRST IN, FIRST OUT



FIRST
IN
FIRST
OUT
THAT'S
WHAT IT'S
ALL
ABOUT



Includes:
(1) 950 ml and
(4) 475 ml inserts,
plus (2) Caddies
to keep condiments
organised

ULTIMATE GARNISH STATION



All-in-one garnish
station includes
(5) swing-out trays,
and (1) sponge



Item #	Description	Min Order/ Case Pack
	ULTIMATE GARNISH STATION – BLACK POLYSTYRENE BASE, CLEAR (PS) LID AND POLYPROPYLENE INSERTS	
a. BCD1400	Ultimate Garnish Station, Includes: (1) 950 ml, (2) Caddies and Integrated 5-Tray Rimming Station, 62 x 18.5 x 16cm	1 ea / 4 ea
	REPLACEMENT PARTS & ACCESSORIES	
105	475 ml Insert, White, 14 x 7 x 7.5cm	1 ea / 12 ea
107	950 ml Insert, White, 14.5 x 14 x 7.5cm	1 ea / 12 ea
b. 667	Round replacement sponge, 14cm dia x 1cm	12 ea

Chillable design for food safety standards



a



Stackable design features bottom rotating lid

US Patent #9,936,822

Item #	Description	Min Order/ Case Pack
FIRST IN, FIRST OUT GARNISH STATION – BLACK ABS PLASTIC BASE, CLEAR ABS LID, POLYPROPYLENE INSERTS		
a. BCD6000	Garnish Station, (6) 710 ml White Inserts, 51 x 17 x 16cm	1 ea
b. BCD6000BK	Garnish Station, (6) 710 ml Black Inserts, 51 x 17 x 16cm	1 ea
CONDIMENT DISPENSERS – BLACK ABS PLASTIC BASE, CLEAR ABS LID, WHITE POLYPROPYLENE INSERTS		
c. 102	6 Compartment Holder with Enclosed Bottom, (6) 475ml, 49.5 x 15.5 x 11cm	1 ea / 6 ea
d. 103	4 Compartment Holder with Enclosed Bottom, (4) 800ml, 49.5 x 15.5 x 11cm	1 ea / 6 ea
e. 104	3 Compartment Holder with Enclosed Bottom, (3) 950 ml, 49.5 x 15.5 x 11cm	1 ea / 6 ea

b



Fill from top, dispense from bottom for an effective food rotation system

CONDIMENT DISPENSERS & CADDIES



BPA FREE

Keep your condiments cool and fresh, perfect for craft cocktails



c

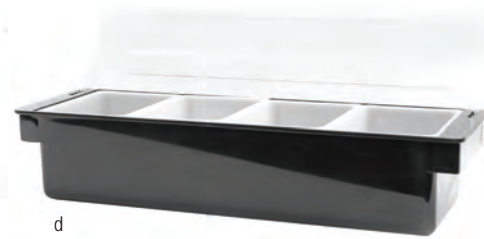

d



e

CONDIMENT DISPENSERS & CADDIES



Clear, lightweight, BPA-Free plastic designs with ice chamber keep your condiments ready to serve! Includes clear plastic bins which are removable for easy cleaning. Lid keeps your fruits and other garnishes fresh and free from contaminants.

- Easy to clean, handwash recommended
- Conveniently packaged for Cash & Carry



c

Pint inserts are dishwasher safe; housing and lid should be washed by hand with a non-abrasive cloth



Tongs included



a



b



e

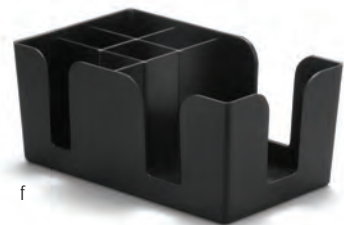

f



d

CHILLIN' CONDIMENT CADDIES

Item #	Description	Min Order/ Case Pack
CONDIMENT DISPENSERS – CLEAR PLASTIC		
a. *10006	Polystyrene with Enclosed Bottom, (4) 700ml Inserts, 41 x 16 x 12.5cm	6 ea
b. *10007	Polystyrene with Enclosed Bottom, (5) 565ml Inserts, 41 x 16 x 12.5cm	6 ea
CONDIMENT DISPENSERS – STAINLESS STEEL, CLEAR ACRYLIC LID		
1602	2 Compartment Holder, (2) 950 ml Plastic Inserts, Holds Four Freeze Packs (4937 not included), Notched Lid, Enclosed Bottom 30.5 x 15 x 12.5cm	1 ea / 16 ea
1603	4 Compartment Holder, (4) 475ml Plastic Inserts, Holds Four Freeze Packs (4937 not included), Enclosed Bottom, 30.5 x 15 x 12.5cm	1 ea / 16 ea
c. *H1604	Bar Caddy Set, Includes (4) 475ml Plastic Inserts and Stainless Steel Tongs, Open Bottom, 30.5 x 15 x 9cm	1 ea / 4 ea
d. 1604	Bar Caddy Set, Includes (4) 475ml Plastic Inserts, Open Bottom, 30.5 x 15 x 9cm	1 ea / 16 ea
1605	5 Compartment Holder, (5) 475ml Plastic Inserts, Open Bottom, 38 x 15 x 9cm	1 ea / 16 ea
1606	6 Compartment Holder, (6) 475ml Plastic Inserts, Open Bottom, 45 x 15 x 9cm	1 ea / 16 ea
REPLACEMENT PARTS & ACCESSORIES		
e. 4937	Freeze Pack for 1602 and 1603	1 ea / 36 ea
1607	475ml Insert, White	1 ea / 120 ea
105	475ml Insert, White	1 ea / 12 ea
107	950ml Insert, White	1 ea / 12 ea
BAR CADDY		
f. 101	Black, 24 x 15 x 10.5cm	1 ea / 12 ea

FLIGHTS AND HANGERS

PADDLE FLIGHTS



- Perfect for serving a variety of drinks or dessert samplings
- Recessed holes for holding small glasses, ramekins, sauce cups, etc.(not included)

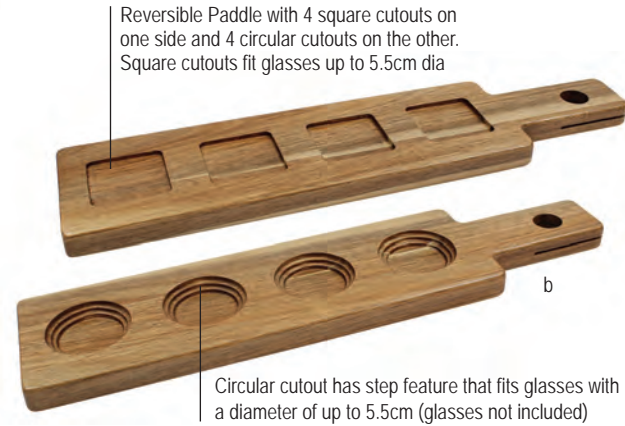

Reversible Paddle with 4 square cutouts on one side and 4 circular cutouts on the other. Square cutouts fit glasses up to 5.5cm dia

Circular cutout has step feature that fits glasses with a diameter of up to 5.5cm (glasses not included)

Item #	Description	Min Order/ Case Pack
PADDLE FLIGHTS		
a. 20002	Better Burger Spatula Drinks Flight, 31 x 8.5cm, with 13cm Handle (Product has (4) 6.3 x 1.8cm Indentations)	1 ea / 12 ea
b. FLIGHT1	Bamboo, Holds 4 Glasses (Up to 5.5cm dia) 43 x 10 x 1.5cm	1 ea / 10 ea
WINE FLIGHT - BLACK POWDER COATED STEEL		
c. WF200BK	Tasting Flight, 19 x 18 x 36cm	1 ea / 4 ea

GLASS HANGERS



Item #	Description	Min Order/ Case Pack
GLASS HANGER - BRASS		
d. GHB10	25.5cm	1 ea / 12 ea
GHB16	40.5cm	1 ea / 12 ea
GHB24	61cm	1 ea / 12 ea
GLASS HANGER - CHROME PLATED METAL		
GHC10	25.5cm	1 ea / 12 ea
GHC16	40.5cm	1 ea / 12 ea
e. GHC24	61cm	1 ea / 12 ea



WINE FLIGHT

- An appealing and convenient way to serve wine tastings
- WF200BK holds up to (3) 12.5cm dia wine glasses (Not Included)

13.5cm maximum stem length

Also a convenient option to serve your condiments and sides

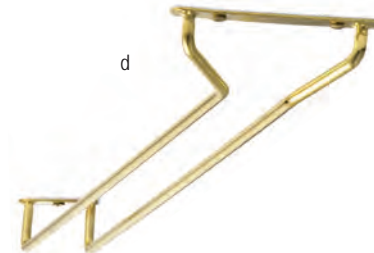

ASSORTED WINE SERVERS & STAINLESS STEEL ICE BUCKETS



For best results with marble coolers, place unit in the freezer before use. Do not fill with ice.



Item #	Description	Capacity	Min Order/ Case Pack
ICE BUCKETS – STAINLESS STEEL			
a. RIB76	Double Wall Bucket, 16cm dia x 16.5cm, 17.5cm dia with Handles	1.7 L	1 ea / 12 ea
WINE SERVER – MARBLE			
b. *5488	Black, 12.5cm dia x 18.5cm	Holds 10cm dia bottle	1 ea / 6 ea
c. *5488W	White, 12.5cm dia x 18.5cm	Holds 10cm dia bottle	1 ea / 6 ea
WINE SERVER – SAN PLASTIC			
d. PB5119	Wine Bucket, 18.5cm dia x 23cm, 22cm dia with Handles	2.6 L	1 ea / 12 ea

WINE & CHAMPAGNE SERVING TOOLS



Item #	Description	Min Order/ Case Pack
WINE/CHAMPAGNE SERVING TOOLS		
e. *H1230C	Waiter's Corkscrew, Black Rubber-Like Handle	6 ea
f. 398	Champagne Bottle Sealer, Stainless Steel	1 ea / 24 ea
*H398	Champagne Bottle Sealer, Stainless Steel	6 ea
g. *H1229	Premium Winged Corkscrew	6 ea

ASHTRAYS



Item #	Description	Min Order/ Case Pack
2-PIECE WINDPROOF – STAINLESS STEEL		
h. WPA5SS	18/8 Stainless Steel, 12.5cm dia	12 ea
2-PIECE WINDPROOF – MELAMINE		
i. WPA5BKEU	Black, 12.5 x 12.5 x 5.08 cm	12 ea
CLASSIC STACKING DEEPWELL, BLACK PHENOLIC		
j. *CST363B-1	Black, 10cm dia (12 per pack)	6 pk
ECONOMY STACKING DEEPWELL, BLACK PHENOLIC		
k. 131B	Black, 8.5cm dia	144 ea
l. ST363B-1	Black, 10cm dia	12 ea
m. 707B	Black, 9cm dia	144 ea

CHAMPAGNE/WINE BUCKETS & STANDS

Our Champagne / Wine Buckets & Stands are great for keeping champagne on ice or wines chilled without taking up valuable tabletop space



Unique
hammered
finish

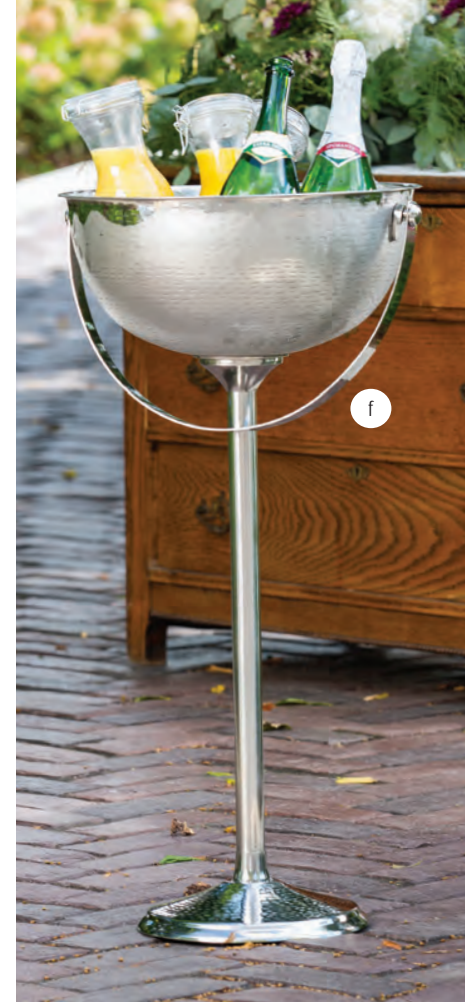
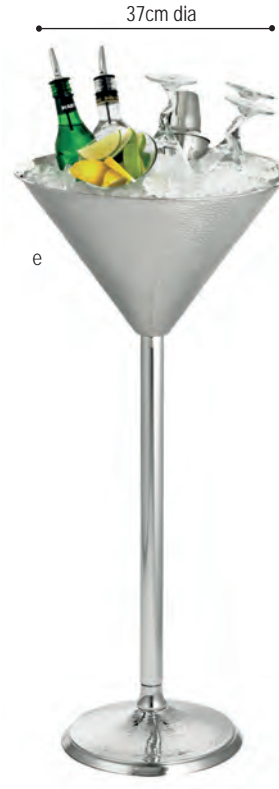

Item #	Description	Capacity	Min Order/ Case Pack
CHAMPAGNE/WINE BUCKETS & STANDS – ASSORTED FINISHES			
a. 5188	Stainless Steel Bucket, Mirror Finish (Fits stand 5288), 22cm dia x 25.5cm, 24cm dia with Handles	7.6 L	1 ea / 6 ea
b. 5288	Chrome Plated Bucket Stand (Fits 5188), 20cm dia x 76cm		1 ea / 12 ea
c. 5198	Stainless Steel Bucket, Shiny Hammered Finish (Fits stand 5398), 20cm dia x 21.5cm, 22cm dia with Handles	7.6 L	1 ea / 6 ea

Item #	Description	Capacity	Min Order/ Case Pack
CHAMPAGNE/WINE BUCKETS & STANDS – ASSORTED FINISHES			
d. 5398	Stainless Steel Bucket Stand (Fits 5198) 20cm dia x 59cm		1 ea / 6 ea
e. RS1432	Remington™ Rice Pattern Martini Glass Beverage Stand, Stainless Steel, 37cm dia x 82.5cm	4.4 L	1 ea
f. RS2132	Remington™ Rice Pattern Round Beverage Stand with Handle, Stainless Steel, 40.5cm dia x 81cm	9.8 L	1 ea

TOP CLASS TABLETOP

Mix & match our tabletop collections to enhance your customers' dining experience. Contemporary in design, our accessories will welcome your guests in a stylish and elegant manner.



COLLECTIONS | 76

- Gemelli Collection™ 76
- Marbella Collection™ 76
- Prima Collection™ 77
- European Collection™ 77
- Beehive Collection™ 78
- Syrup Dispenser 79
- Salad Dressing Gadgets 79
- Seafood Tools 79
- Siena Collection™ 80
- Serving Bottles 80



SALT & PEPPER | 80

- Eiffel Tower Salt & Pepper Shakers 80
- Nostalgia Salt & Pepper Shakers 80
- Cube Salt & Pepper Shakers 80
- Resealable Salt & Pepper Shakers 80
- Mason Jar Salt & Pepper Shakers 80
- Mini Mason Jar Salt & Pepper Shakers 80
- Paneled, Square & Round
Salt & Pepper Shakers 81
- Salt and Pepper Mill Sets 82
- Large Pepper Mill 82
- Authentic Collection™ 83
- Condiment Jar 83

SHAKERS & TABLETOP CADDIES | 84

- Plastic Shakers 84
- Glass Shakers 84
- Versa Rack™ Condiment Racks 85
- Paper Towel Holder & Caddy 85
- Table Sachet Holders 85

GO GREEN AUTHENTICALLY.

Our Eco-friendly Authentic Collection™ oil and vinegar and salt and pepper shaker bottles are made from recycled green. See page 87 for details.





AROUND THE WORLD TO YOUR TABLETOP

GEMELLI COLLECTION™

- Green tint glass bottles are dishwasher safe
- Racks and pourers are hand wash only



MARBELLA COLLECTION™

- Eco-friendly, recycled green glass
- Green tint glass bottles are dishwasher safe
- Tops are hand wash only



Item #	Description	Capacity	Min Order/ Case Pack
GEMELLI COLLECTION™ – CHROME PLATED METAL RACKS			
a. *H918N	3-pc Set, includes (2) 8.5 oz Bottles with Pourers (599P) & Chrome Plated Rack (918R), 12 x 9 x 30.5cm	250 ml	6 ea
REPLACEMENT PARTS & ACCESSORIES			
b. 918	2-pc Set, includes (2) 8.5 oz Bottles with Pourers (599P)	250 ml	6 ea
	918R Rack for 918, 12 x 9 x 30.5cm		1 ea / 6 ea
c. 599P	18-8 Stainless Steel Universal Pourer with Plastic Vent Tube		12 ea / 60 ea
d. 597P	18-8 Stainless Steel Weighted Flip Cap Pourer		12 ea / 60 ea
MARBELLA COLLECTION™ – RECYCLED GREEN GLASS, CHROME PLATED METAL TOPS			
e. 615	3 oz Salt & Pepper Shakers with Chrome Plated ABS Tops (615T)	90 ml	24 ea

PRIMA COLLECTION™



- Green tint glass bottles are dishwasher safe
- Racks and pourers are hand wash only

CLASSIC CRUETS

Item #	Description	Capacity	Min Order/ Case Pack
PRIMA COLLECTION™– STAINLESS STEEL POURERS, CHROME PLATED OR BLACK POWDER COATED METAL RACKS			
a.	*H9085N 3-pc Set, 8.5 oz, Includes: (2) 9085 & (1) 9085R, 11 x 6 x 32cm	250 ml	6 ea
b.	*H9085NBK Black 3-pc Set, 8.5 oz, Includes: (2) 9085 & (1) 9085RBK, 11 x 6 x 32cm	250 ml	6 ea
c.	*H916N 3-pc Set, 16 oz, Includes: (2) 916 & (1) 916R, 13 x 7 x 38cm	470 ml	6 ea
d.	RSB33 Resealable Prima Bottle	1L	12 ea
e.	60125 Clear Bottle, 6 oz with Stainless Steel Pourer (599P)	180 ml	12 ea
f.	9085 Clear Bottle, 8.5 oz with Stainless Steel Pourer (599P)	250 ml	12 ea
	916 Clear Bottle, 16 oz with Stainless Steel Pourer (599P)	470 ml	12 ea
REPLACEMENT PARTS & ACCESSORIES			
	9085R Rack for H9085N, 11 x 6 x 32.5cm		1 ea / 6 ea
	9085RBK Black Rack for H9085NBK, 11 x 6 x 32.5cm		1 ea / 6 ea
	916R Rack for H916N, 13 x 6.5 x 37cm		1 ea / 6 ea
	599P 18-8 Stainless Steel Universal Pourer with Plastic Vent Tube		12 ea / 60 ea
EUROPEAN COLLECTION™– STAINLESS STEEL TOPS, CHROME PLATED METAL RACKS			
g.	600N 3-pc Set, 6 oz, Includes: (2) 600 & (1) 600R	175 ml	1 ea / 6 ea
REPLACEMENT PARTS & ACCESSORIES			
h.	600 6 oz Bottle with 18-8 Stainless Steel Top (600T)	180 ml	12 ea



EUROPEAN COLLECTION™



- Clear glass bottles are dishwasher safe
- Racks and tops are hand wash only



WELCOME TO THE **HIVE**

BEEHIVE
COLLECTION™



- Collection designed for all table and buffet settings
- Choose from a wide range of shapes, capacities and dispenser tops



b



d



c



e



a

Item #	Description	Capacity	Min Order/ Case Pack
BEEHIVE COLLECTION™ – GLASS, ABS, STAINLESS STEEL & CHROME PLATED METAL			
a.	BH2 Salt & Pepper Shakers, 2 oz with Top (154T).	60 ml	24 ea
b.	BH3 Oil & Vinegar Bottles, 6 oz with Top (600T)	180 ml	12 ea
c.	BH7 Syrup Dispenser, 6 oz with Top (1370T)	180 ml	12 ea
d.	BH855 Pourer, 12 oz, Center Pour with Top (55T)	350 ml	12 ea
e.	*HBH860 Pourer, 12 oz, Pour Spout with Top (60T)	355 ml	12 ea
REPLACEMENT PARTS & ACCESSORIES			
600T	18-8 Stainless Steel Top for BH3, 600, 600N, 600ST, H600N2	–	12 ea
1370T	Chrome Plated Metal Top for BH7	–	1 ea / 24 ea
1370G	Gasket for BH7	–	1 ea / 12 ea
55T	Stainless Steel Tops for BH855	–	12 ea

SYRUP DISPENSER

GLASS WITH ABS TOP

- Easy-to-use dispensing options for syrups and thick sauces



SALAD DRESSING DISPENSERS

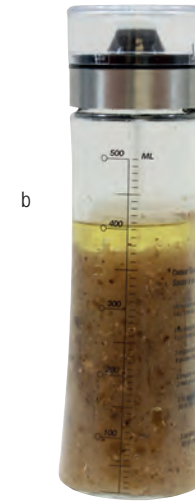

Item #	Description	Capacity	Min Order/ Case Pack
GLASS SYRUP DISPENSERS—CHROME PLATED METAL ABS TOPS			
a. 406	6 oz, Chrome Plated Metal Top	180 ml	12 ea
GLASS WITH PLASTIC & METAL TOP			
b. *HDS492	Salad Dressing Shaker	550 ml	6 ea
c. *HVN142	Olive Oil Infuser	550 ml	6 ea

SEAFOOD TOOLS



Item #	Description	Min Order/ Case Pack
SEAFOOD TOOLS—METAL		
d. 513	Round Handle Lobster Crackers, Chrome Plated	1 ea / 24 ea
e. 514	Double Jaw Lobster Crackers, Chrome Plated	1 ea / 24 ea
f. 515	Lobster Crackers, Red Enamelled Cast Aluminium	1 ea / 24 ea
g. *522	Shellfish Forks, Chrome Plated (4 per pack)	1 pk / 12 pk

SWEET OR SAVORY



SIENA COLLECTION™



- Glass bottles are dishwasher safe
- Racks and tops are hand wash only



Item #	Description	Capacity	Min Order/ Case Pack
SIENA COLLECTION™ – CLEAR GLASS, STAINLESS STEEL POURERS			
a. 611	Bottle, 6 oz with Pourers (599P)	180ml	12 ea
b. 611N	Set of (2) 611 Bottles and Chrome Plated Rack	180ml	1 ea / 6 ea

SERVING BOTTLES OIL & VINEGAR



*



Item #	Description	Capacity	Min Order/ Case Pack
OIL & VINEGAR SERVING BOTTLES – CLEAR GLASS BOTTLES, STAINLESS STEEL POURERS			
c. *H931	Clear Glass Bottle, 16 oz with Pourer (599P)	475 ml	6 ea
REPLACEMENT PARTS & ACCESSORIES			
599P	18-8 Stainless Steel Universal Pourer with Plastic Vent Tube	–	12 ea / 60 ea
597P	Weighted Flip Cap Pourer with Stainless Steel Vent Tube	–	12 ea / 60 ea

SALT & PEPPER SHAKERS



d



e



f

Item #	Description	Capacity	Min Order/ Case Pack
RESEALABLE SHAKERS –GLASS SHAKERS, S/S CLIP TOP			
d. *H15S&P	1.5 oz Clear Glass, 7 x 4.5 x 6.5cm	45 ml	6 ea
MASON JAR SHAKERS–GLASS SHAKERS, S/S TOP			
e. *H475S&P	4.75 oz Clear Glass, 7.5 x 5.5 x 8.5cm	140 ml	6 ea
REPLACEMENT PARTS & ACCESSORIES			
H475T	Stainless Steel Top for H475S&P	–	12 ea
MINI MASON JAR SHAKERS–GLASS SHAKERS, S/S TOP			
f. *C170-12	1.5 oz Clear Glass, (Pack of 12) 5 x 4 x 6.5cm	45 ml	1 pk / 4 pk
REPLACEMENT PARTS & ACCESSORIES			
H475ST	Stainless Steel Solid Top for H475S&P	–	12 ea

SHAKE...SHAKE... SHAKE THEM UP!



Item #	Description	Capacity	Min Order/ Case Pack
PANELED GLASS SHAKERS-S/S TOP			
a.	150S&P-2 1 oz Shaker with Top (150T)	30 ml	24 ea
b.	155S&P-2 2 oz Shaker with Top (150T)	60 ml	24 ea
c.	156S&P-2 3 oz Shaker with Top (156T)	90 ml	24 ea
SQUARE GLASS SHAKERS-S/S TOP			
d.	154S&P-2 2 oz Shaker with Top (154T)	60 ml	24 ea
ROUND GLASS SHAKERS-S/S TOP			
e.	132S&P-2 3 oz Shaker with Top (132T)	90 ml	24 ea
EIFFEL TOWER CLEAR GLASS SHAKERS-CHROME PLATED TOPS†			
f.	83S&P 1 oz Shaker with Top (83T) Fine multi hole tops	30 ml	24 ea
	83S 1 oz Shaker with Top Fine single hole tops	30 ml	24 ea
	83P 1 oz Shaker with Top Coarse multi hole pepper tops	30 ml	24 ea
NOSTALGIA GLASS SHAKERS-STAINLESS STEEL TOPS			
g.	163S&P-2 1.5 oz Shaker with Top (163T)	45 ml	24 ea
CUBE GLASS SHAKERS-CHROME PLATED ABS TOP†			
h.	30S&P 0.5 oz Shaker with Top (83T)	15 ml	24 ea
REPLACEMENT PARTS & ACCESSORIES			
83T1	Single Hole Chrome Plated Metal Tops, for 83S&P, 83S & 83P		12 ea
83T	Fine Multi Hole Top, Nickel Plated, for 30S&P & 83S&P		24 ea
83TP	Coarse Multi Hole Pepper Top, Nickel Plated, for 83S&P		24 ea
163T	Stainless Steel Top for 163S&P-2		24 ea

† Hand wash only





SALT & PEPPER MILL SET



Our new 18cm Stainless Steel salt & pepper mill set is the perfect addition to the tabletop setting. These sets are perfect for grinding coarse peppercorns and salt.

- Set includes a salt & pepper mill for the tabletop
- Conveniently packaged for Cash & Carry
- Manufacturer's Lifetime Warranty (Ceramic Grinding Mechanism)
- Handwash only

ACRYLIC SALT & PEPPER MILL AND SHAKER COMBO

Upgrade your tabletop with our new acrylic salt & pepper mill combo. This is great for shaking salt or grinding coarse pepper corns.

- Single mill with a shaker and grinder mill combo
- Conveniently packaged for Cash & Carry
- Manufacturer's Lifetime Warranty (Ceramic Grinding Mechanism)
- Handwash only



NEW



d

Item #	Description	Capacity	Min Order/ Case Pack
SALT & PEPPER MILLS, SET OF 2 - STAINLESS STEEL, ACRYLIC			
a. 10924	1.5oz Salt and Pepper Mill Set, 5.5cm dia x 13cm	45 ml	1 set / 6 sets
b. 11689 ▶	4 oz Salt and Pepper Set, 6.5cm dia x 18cm	120 ml	1 set / 6 sets
SALT & PEPPER MILLS, SET OF 2 - BLACK AND WHITE, PLASTIC			
c. 10925	1.5oz Salt and Pepper Set, 5.5cm dia x 13cm	45 ml	1 set / 6 sets
SALT SHAKER & PEPPER MILL COMBINATION - ACRYLIC			
d. 11832 ▶	Salt & Pepper Mill Combo Clear 6.5 x 5 x 19cm Acrylic, 30ml Shaker and 75ml Mill	30 ml / 75 ml	1 ea / 6 ea
WOOD PEPPER MILLS - MAHOGANY FINISH†			
e. PM1918	46cm Pepper Mill		1 ea / 12 ea



Scan code to view a video on our Salt & Pepper Combo Mill.



Durable, forged steel mechanism to withstand daily use



e



a



b

AUTHENTIC COLLECTION™

- Eco-friendly recycled green glass
- Glass bottles are dishwasher safe
- Tops are hand wash only



Item #	Description	Capacity	Min Order/ Case Pack
AUTHENTIC COLLECTION™ – RECYCLED GREEN GLASS			
a. 6619	Bottles, 6oz with Pourers (599P)	355 ml	12 ea
b. 6618	Salt & Pepper Shakers, (2) 4 oz with Tops (163T)	120 ml	24 ea

CONDIMENT JAR

Item	Description	Capacity	Min Order/ Case Pack
GLASS CONDIMENT JAR SET – STAINLESS STEEL*			
c. *357	6 oz Condiment Jar Set, Includes: Glass Jar, Stainless Steel Lid and Spoon	180 ml	1 ea / 48 ea



c



a



b



c



d

GETTING **SPICY** WITH IT

Use our shakers to spice up your pizza service



e



f



g



h



i

Item #	Description	Capacity	Min Order/ Case Pack
SWIRL BPA-FREE TRITAN® PLASTIC SHAKERS—CHROME PLATED METAL TOPS			
a.	P260 6 oz, Perforated Top, 7cm dia x 9cm	180 ml	24 ea
b.	P260SL 6 oz, Slotted Top, 7cm dia x 9cm	180 ml	24 ea
SWIRL GLASS SHAKERS—CHROME PLATED METAL TOP			
c.	260 6 oz, Perforated Top, 7cm dia x 9cm	180 ml	36 ea
d.	260SL 6 oz, Slotted Top, 7cm dia x 9cm	180 ml	36 ea
FLUTED GLASS, STAINLESS STEEL TOPS			
*800-4	12 oz, Fluted Perforated Shakers, Pack of 4, 8cm dia x 14.5cm	355 ml	1 pk
e.	55S-4 12 oz, Fluted Centre Pour Shaker, Pack of 4, 8cm dia x 15cm	355 ml	1 pk
f.	P55S 12 oz, Swirl Shaker Center Pour Top, 7.5cm dia x 14.5cm	355ml	24 ea
g.	P57S 12 oz, Fluted Shaker Side Flap Top, 7.5cm dia x 14.5cm	355ml	24 ea
*C57S-4	12 oz, Shaker with Side Flap Top, Pack of 4, 7.5cm dia x 14.5cm	355 ml	4 pk
FLUTED BPA FREE TRITAN®, PLASTIC TOPS			
h.	P800BK 12 oz Shaker with Perforated Top, Black (4mm holes)	355 ml	24 ea
BPA FREE TRITAN®, STAINLESS STEEL TOPS			
i.	P800 12 oz Shaker with Perforated Top (4mm holes)	355 ml	24 ea

* Cash & Carry item

VERSA RACK™



- Keep tabletops organised while saving space and labour
- Holds a variety of condiments
- Each features a merchandising ring that functions as a handle for easy carrying to and from the table

Item #	Description	Min Order/ Case Pack
VERSA RACK™ – BLACK POWDER COATED METAL		
a.	BKDIA595 16.5cm dia x 25.5cm, Black	2 ea
b.	BKDIA728 20.5cm dia x 25.5cm, Black	2 ea
TOWEL HOLDER & CADDY – BLACK POWDER COATED METAL		
c.	10263 25.5cm x 15cm x 31cm	1 ea

TABLE SACHET HOLDERS



- Our wide range of table sachet holders are a simple, stylish and hygienic way to serve pre-portioned condiment sachets or sugar packets
- Available in a variety of materials, sizes and styles to fit any décor

Item #	Description	Min Order/ Case Pack
PREMIUM TABLE SACHET HOLDERS–STAINLESS STEEL OR POWDER COATED		
d.	1155 5cm dia x 7cm, Round, Brushed Stainless Steel	1 ea / 12 ea
e.	1157 8 x 6.5 x 4.5cm, Rectangular, Brushed Stainless Steel	1 ea / 12 ea
f.	BK155 5cm dia x 6.5cm, Round, Black Powder Coated	12 ea
ASSORTED TABLE SACHET HOLDERS*		
g.	*C56W 8.5 x 6.5 x 5cm, White, Polystyrene (6 per Pack)	1 ea / 6 ea
h.	*10308 8.5 x 6.5 x 5cm, Clear, Polystyrene (6 per Pack)	1 ea / 6 ea
i.	56B 8 x 6 x 5cm, Black, Polystyrene (PS)	24 ea
	56C 8 x 6 x 5cm, Clear, Polystyrene (PS)	24 ea
	*10309 8.5 x 6.5 x 5cm, Black, Polystyrene (6 per Pack)	1 ea / 6 ea



PAPER TOWEL HOLDER & CONDIMENT CADDY



- Provide an attractive solution for dispensing universal low-fold and tall-fold napkins
- One-at-a-time dispensing for any size table



Shown with our Squeeze Bottles (not included)

Stylish solution for room service tea and coffee serving



SERVING SOLUTIONS WITH EVERY MEAL

Whether you're serving up elegant appetizers or you're looking for a durable, fail-safe solution, TableCraft has a variety of serving options to help your operation to be more efficient. Choose from a variety of materials, sizes, and colours to create a custom look for every meal services' operational needs.



APPETISERS AND SIDE SERVERS | 88

Mini Paellas & Braziers.....	88
Mini Servers.....	88
Mini Casserole.....	88
Tri-Ply Tabletop Mini Servers.....	88
Kadai Dishes	89
Sheet Pans, Pie Pans.....	90
Taco Taxi™ Servers.....	91
Fajita Tower	91
Sauce Cups	92
Handled Side Server	93
Fry Cups	93
Sauce Boats	93
Cast Iron Servers	94
Cast Iron Underliners.....	95
Sizzle Platter Set	95

SERVING COLLECTIONS | 97

Brickhouse Collection™.....	97
Lattice Collection™.....	98
Acacia Collection™	101

SERVING BASKETS | 103

Handwoven Baskets.....	103
Ridal Collection™.....	103
Artisan Collection™.....	104
Parisian Collection™.....	104
Bouclé Collection™.....	105
Delta Collection™.....	105
Petal Collection™.....	105
Classic Plastic Baskets and Platters	106



Our Pie Pan servers are great and convenient for cooking and serving all in one pan. From casual dining to quick serve restaurants.

See page 90 for these and more serving options.



MINI SERVERS

- Perfect for an upscale table display and side serving
- 18/8 Interior with 18/0 base plate
- Single ply with clad base



MINI CASSEROLE

- Perfect presentation for individual soups, mac and cheese, or sides
- Lid allows vessel to stack perfectly to conserve space and keep covered



Lids designed to stack for presentation and storage (lids and casseroles sold separately)



MINI PAELLAS & BRAZIER

- Perfect for single-serve tapas or paella
- Cook & serve all-in-one
- Also a unique serving vessel for other cuisines and desserts



Item #	Description	Capacity	Min Order/ Case Pack
MINI PAELLA – STAINLESS STEEL			
a. 10289	4½oz Mini Paella Pan, 12cm dia x 2cm H 16cm dia with handles	135ml	1 ea / 12 ea
b. 10290	6½oz Mini Paella Pan, 15cm dia x 2cm H 19cm dia with handles	190ml	1 ea / 12 ea
MINI BRAZIER – STAINLESS STEEL			
10291	12oz Mini Brazier with Handles, 12.5cm dia x 3.5cm H 18cm dia with handles	355ml	1 ea / 12 ea
c. 10292	16oz Mini Brazier with Handles, 15cm dia x 3.5cm H 20.5cm dia with handles	475ml	1 ea / 12 ea
d. 846	17oz Rectangular Mini Roast Pan, 15 x 9.5 x 5cm, 19cm width with Handles	500ml	1 ea / 6 ea
e. 833	14oz Square Mini Roaster with Handles, 11.5 x 11.5 x 5cm, 16cm width with Handle	415ml	1 ea / 12 ea
f. 850	26oz Square Mini Roast Pan, 14 x 14 x 5.5cm, 18cm width with Handles	770ml	1 ea / 12 ea
MINI CASSEROLE – STAINLESS STEEL			
g. 10303	16oz, Round with Handles, 12.5cm dia x 5cm 14.5cm dia with Handles (Lid Sold Separately)	500ml	1 ea / 12 ea

TRI-PLY TABLETOP MINI SERVER

- Bring style to your serving presentation with this high quality mini server
- Versatile option: cook and serve in the same dish
- 18/8 Stainless Steel interior, 18/0 Stainless Steel exterior and aluminium core
- Lids sold separately



To view our collection of full size Tri-Ply cookware, see page 10

Item #	Description	Capacity	Min Order/ Case Pack
TRI-PLY TABLETOP MINI SERVERS – STAINLESS STEEL			
a. CW7000	Casserole Server, 16cm dia x 6.5cm, 23cm dia with Handles	1.1 L	1 ea / 10 ea
b. CW7000LM	Glass Lid for CW7000, 16cm dia (sold separately)		1 ea / 20 ea
c. CW7000L	Lid for CW7000, 16cm dia (sold separately)		1 ea / 20 ea

KADAI DISHES



Item #	Description	Capacity	Min Order/ Case Pack
KADAI DISHES – STAINLESS STEEL			
c. 839	Kadai Bowl, 13.5cm dia x 5.5cm, 17cm dia with Handles	590ml	1 ea / 6 ea
d. 840	Kadai Bowl, 15.5cm dia x 7cm, 20cm dia with Handles	830ml	1 ea / 6 ea
KADAI DISHES – COPPER PLATED STAINLESS STEEL			
e. 848	Handled Handi Dish, Mirror Finish with Hammered Pattern, 16cm dia x 5.5cm, 18.5cm dia with Handles	890ml	1 ea / 6 ea
HANDI DISHES – COPPER PLATED STAINLESS STEEL			
f. 843	Handi Dish, Mirror Finish with Hammered Pattern, 13cm dia x 5.5cm	890ml	1 ea / 12 ea



SERVING SOLUTIONS
PAELLA, BRAZILERS, KADAI AND TRI-PLY TABLETOP

SHEET PAN & PIE PAN SERVERS

- Not just for baking; Sheet Pan Servers offer an alternative to serving large portions of chicken, smokehouse barbeque, or burgers
- Our Pie Pan servers are great for cooking and serving all in one pan! Ideal for baking pies, cakes and other desserts and entrees or for serving sandwiches, paninis and sides!
- Great for family style serving, catered events, or in high volume service
- Stainless Steel servers are dishwasher safe; Aluminium servers are hand wash recommended

SIDE PRESENTATIONS



Cost-effective way to dress your tabletop

NEW

Etched Weave Pattern gives a nostalgic nod to the plastic trays of the past

Stainless Steel makes this tray stylish and modern



Item #	Description	Min Order/ Case Pack
SHEET PAN SERVERS		
a. 913A	Sheet Pan, 19 GA Aluminium, Shiny Finish 33 x 24 x 3cm	1 ea / 12 ea
913AS	Sheet Pan, 23 GA Aluminised Steel, Matte Finish 33 x 24 x 3cm	1 ea / 12 ea
b. 1006AS	Sheet Pan, 23 GA Aluminised Steel, Matte Finish 25.5 x 15 x 2.5cm	1 ea / 12 ea
PIE PAN SERVERS		
ALUMINIUM (Hand wash recommended)		
c. 11655 ▶	15cm dia x 2.5cm (0.7 mm Thickness)	1 ea / 12 ea
d. 10545	23cm dia x 2.5cm (0.7mm thickness)	1 ea / 12 ea
e. 10546	26cm dia x 2cm (0.7mm thickness)	1 ea / 12 ea
STAINLESS STEEL (Dishwasher safe)		
f. 11656 ▶	15cm dia x 2.5cm (0.7 mm Thickness)	1 ea / 12 ea
g. 10547	23cm dia x 2.5cm (0.5mm thickness)	1 ea / 12 ea
10548	26cm dia x 2cm (0.5mm thickness)	1 ea / 12 ea
SERVING TRAY		
STAINLESS STEEL WITH WEAVE PATTERN		
h. 20005	Better Burger Collection™ Serving Tray, 25.5 x 18 x 1.5cm	1 ea / 12 ea

TACO TAXI™

- Prep and serve your hard or soft shell taco creations in style
- Perfectly designed to cradle your stuffed creations
- Stainless Steel servers are safe for temperatures up to 260°C



Keeps your tacos upright and easy to eat!



Item #	Description	Min Order/ Case Pack
TACO TAXI™ SERVERS – STAINLESS STEEL WIRE		
TRW12	Holds 1-2 Tacos, 9 x 5.5 x 4cm	1 ea / 12 ea
a. TRW23	Holds 2-3 Tacos, 14 x 5.5 x 4cm	1 ea / 12 ea
b. TRW34	Holds 3-4 Tacos, 19 x 5.5 x 4cm	1 ea / 12 ea
TACO TAXI™ SERVERS – STAINLESS STEEL BRUSHED FINISH, SOLID		
TRS12	Holds 1-2 Tacos, 9 x 5.5 x 4cm	1 ea / 12 ea
TRS23	Holds 2-3 Tacos, 14 x 5.5 x 4cm	1 ea / 12 ea
c. TRS34	Holds 3-4 Tacos, 19 x 5.5 x 4cm	1 ea / 12 ea
TACO TAXI™ SERVERS – STAINLESS STEEL BRUSHED FINISH, CIRCLE PATTERN		
TRSP12	Holds 1-2 Tacos, 9 x 5.5 x 4cm	1 ea / 12 ea
TRSP23	Holds 2-3 Tacos, 14 x 5.5 x 4cm	1 ea / 12 ea
d. TRSP34	Holds 3-4 Tacos, 19 x 5.5 x 4cm	1 ea / 12 ea
FAJITA TOWER – BLACK POWDER COATED METAL		
e. FTR1711	Rack with Rubber Feet, Black Powder Coated Metal, 28.5 x 20.5 x 45cm. (19.2cm dia Shelves)	1 ea / 6 ea
FAJITA ACCESSORY		
f. 557TCH	Charcoal Tortilla Server, 19.5cm dia x 4.5cm (fits FTR1711)	1 ea / 12 ea
TIERED RISER – BLACK POWDER COATED METAL		
g. BKP4	Four Tiered Stand, 23cm dia x 37cm h	1 ea / 4 ea



Not just for fajitas!
Perfect for any stackable serving.



TIERED RISER

Use our Four-Tiered Stand (BKP4) with the Pulito Pasta Bowls (not included) to display fresh fruit, salad and fajita toppings, and more.

RAMEKINS AND SAUCE CUPS



NEW

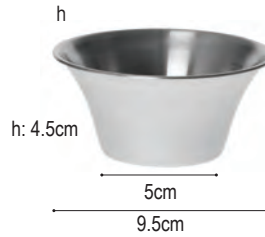
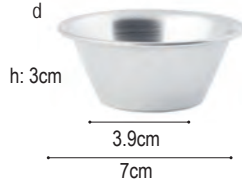
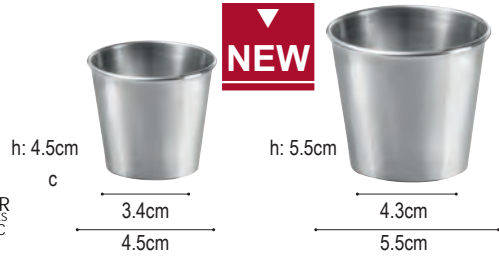

Item #	Description	Capacity	Min Order/ Case Pack
ROUND SAUCE CUPS – STAINLESS STEEL			
a.	12159 ▶ 1.7oz, 4.5cm dia x 4.5cm	50ml	24 ea
b.	12160 ▶ 3.3oz, 5.5cm dia x 5.5cm	100ml	24 ea
c.	5066 1.5oz, 6.5cm dia x 2.6cm	45ml	12 ea
d.	5068 2oz, 7cm dia x 3cm	60ml	72 ea
e.	5067 2.5oz, 6cm dia x 4.3cm	75ml	12 ea
f.	240010 3oz, Tall, Flared, 6.5cm dia x 4cm	90ml	12 ea
g.	5063 4oz, Flared, 8cm dia x 4cm	120ml	12 ea
h.	5064 6oz, Flared, 9.5cm dia x 4.5cm	180ml	12 ea
i.	5071 3oz, 7cm dia x 4cm	90ml	12 ea
j.	5072 4oz, 7.5cm dia x 5cm	120ml	12 ea
k.	5073 6oz, 8cm dia x 5.5cm	180ml	12 ea
BRICKHOUSE COLLECTION™ – STAINLESS STEEL			
l.	GRSS1 1.5oz, 6cm dia x 2.5cm	45ml	12 ea
m.	GRSS2 2.5oz, 5.5cm dia x 4.5cm	75ml	12 ea
n.	GRSS3 3oz, 7cm dia x 4.5cm	90ml	12 ea

FRY CUPS



• Serve your starters in style with these stainless steel snack bowls

Item #	Description	Capacity	Min Order/ Case Pack
FRY CUPS – STAINLESS STEEL			
a.	AC885S Round Server, Brushed Finish, 8.5cm dia x 8.5cm	415ml	1 ea / 12 ea
b.	AC885H Round Server, Hammered Finish, 8.5cm dia x 8.5cm	415ml	1 ea / 12 ea
SAUCE BOATS – STAINLESS STEEL			
c.	9803 3oz Stackable, 11 x 6.5 x 5cm	90ml	1 ea / 24 ea
d.	9805 5oz Stackable, 13 x 6.5 x 6cm	150ml	1 ea / 12 ea
	9808 8oz Stackable, 15 x 7.5 x 7cm	240ml	1 ea / 12 ea
	9812 12oz Stackable, 16 x 9 x 7cm	355ml	1 ea / 12 ea



a

b



c

d

SAUCE BOATS



- Portion-sized sauce boats, in a variety of sizes
- Stackable design for easy storage with a brushed finish to hide fingerprints



200ml

j

300ml

k

400ml

l

SIDE SERVERS



Stainless Steel Side Servers are perfect for portioned control sides. These side servers create a casual dining experience and are perfect for serving your sides such as potatoes, vegetables, and mac and cheese.

- Great for indoor or outdoor service
- Stainless Steel construction
- Easy to clean, dishwasher safe

Item #	Description	Capacity	Min Order/ Case Pack
HANDLED SIDE SERVER - STAINLESS STEEL			
j.	11435 ▶ 7.5oz Side Server, 17 x 8 x 4.5cm	200ml	1 ea / 12 ea
k.	11436 ▶ 10oz Side Server, 19 x 9 x 4.5cm	300ml	1 ea / 12 ea
l.	11437 ▶ 12oz Side Server, 19.5 x 9.5 x 5cm	400ml	1 ea / 12 ea





CAST IRON COOKWARE



a



b



d



e

CAST IRON UNDERLINERS

• Protect tables and countertops from hot cast iron

Assorted Ramekins that fit platters (sold separately):

- RAM2FBKEU & RAM2FWEU
- RAM2WEU & RAM2BKEU
- RAM3WEU
- RAM3RWEU, RAM3RREU, RAM3RBKEU, RAM3RXEU
- RAM4RWEU, RAM4RBKEU
- 5063
- 5073



f

Platter #10746 and Oval Au Gratin #CW30100 (shown on page 95) fit these serving boards



g

10709 & 10710:
23.5 x 9.5cm Oval Cut-Out
& (4) 5.5cm Circular Cutouts

CAST IRON WORKS

- Pre-seasoned, naturally non-stick & easy to clean
- Simple solution for cooking and serving from one dish
- Durable and dependable, a good option for extended use
- For more detailed care and use instructions see page 137 in back of book
- Safe to -17°C

Item #	Description	Capacity	Min Order/ Case Pack
CAST IRON COOKWARE			
a.	*CW30152 Fajita Platter, 19cm dia x 3.5cm, 26cm dia with Handles	710ml	1 ea / 6 ea
b.	*CW30114 Square Pan, 27 x 27 x 5.5cm, 33cm width with Handles	2.6 L	1 ea / 4 ea
c.	*CW30116 Wok, 36.5 dia x 11.5cm, 44.5cm dia with Handles	5.7 L	1 ea / 4 ea
d.	*CW30118 Pizza Pan, 34.5cm dia x 2cm, 44.5cm dia with Handles	—	1 ea / 4 ea

Item #	Description	Min Order/ Case Pack
TORTILLA PRESS		
e.	10711 20cm dia Tortilla Press	1 ea / 4 ea

Item #	Description	Min Order/ Case Pack
FAJITA SERVING BOARDS – ACACIA WOOD		
f.	10710 Oval, 43.5 x 31 x 2cm	1 ea / 12 ea
g.	10709 Rectangular, 47 x 22.5 x 2cm	1 ea / 12 ea

Item #	Description	Capacity	Min Order/ Case Pack
ROUND CASSEROLES WITH LID			
a.	CW30110 10cm dia x 8.5cm, 13cm dia w/ Handles	240ml	1 ea / 4 ea
	CW30148 13cm dia x 9.5cm, 18cm dia w/ Handles	530ml	1 ea / 6 ea
OVAL CASSEROLES WITH LID			
b.	CW30112 12.5 x 9.5 x 8cm, 15.5cm dia w/ Handles	240ml	1 ea / 4 ea
OVAL AU GRATIN			
c.	CW30100 21.5 x 15.5 x 6.5cm, 27cm dia w/ Handles	710ml	1 ea / 6 ea
ROUND SKILLETS			
	CW30122 10cm dia x 3.5cm, w/ 9.5cm Handle	90ml	1 ea / 6 ea
	CW30124 14.5cm dia x 3cm, w/ 12cm Handle	240ml	1 ea / 6 ea
d.	CW30108 14cm dia x 4cm, w/ 9cm Handle	355ml	1 ea / 6 ea
ROUND SERVERS			
e.	CW30102 12.5cm dia x 4cm, 16.5cm dia with Handles	240ml	1 ea / 6 ea
	CW30104 13.5cm dia x 4.5cm, 18cm dia with Handles	355ml	1 ea / 6 ea
	CW30142 16cm dia x 4cm, 20.5cm dia with Handles	530ml	1 ea / 6 ea
	CW30140 18.5cm dia x 5cm, 23cm dia with Handles	830ml	1 ea / 6 ea
	CW30152 19cm dia x 3.5cm, 26cm dia with Handles	710ml	1 ea / 6 ea
SQUARE SERVERS			
f.	CW30150 12.5 x 12.5 x 4cm, 17.5cm width with Handles	355ml	1 ea / 6 ea
SIZZLE PLATTER			
g.	10746 Oval, 23.5 x 17 x 1.5cm	—	1 ea / 6 ea
KETTLE			
h.	CW30151 13cm dia x 8cm	475ml	1 ea / 6 ea
CAST IRON LINERS			
i.	10764 Acacia Wood Underliner for Cast Iron Oval Skillet (10746)	—	1 ea / 40 ea
j.	FSR3 Cast Iron Sizzle Platter Set, Wooden Liner and Glove, 40.5 x 23 x 4cm	—	1 ea / 6 ea

Protect tables and countertops from hot cast iron



Includes a heat-safe mitt for easy and safe transportation to the table



WELCOME TO THE **BRICKHOUSE** COLLECTION™

- Perfect for indoor and outdoor dining;
fast-casual serving solutions
- Available in a variety of styles and sizes;
for serving shareable sides, entrees or
beverage options



NEW



Item #	Description	Capacity	Min Order/ Case Pack
BRICKHOUSE COLLECTION™ – STAINLESS STEEL WITH EMBOSSED BRICK PATTERN			
MUGS			
a.	11659 ▶ Round Mug, 12 x 9 x 9cm Stainless Steel (200 Series)	500ml	1 ea / 12 ea
b.	11660 ▶ Round Mug, 14.5 x 10 x 10cm Stainless Steel (200 Series)	700ml	1 ea / 12 ea
PLATTERS			
c.	GPSS8 Round, 21cm dia x 4.5cm	945ml	1 ea / 12 ea
	GPSS10 Round, 27.5cm dia x 4cm	1.5 L	1 ea / 12 ea
d.	GPSS96 Oval, 25 x 15 x 6cm	1.2 L	1 ea / 12 ea
e.	GPSS129 Oval, 31 x 22 x 6cm	3 L	1 ea / 12 ea
	GPSS89 Rectangular, 28 x 18.5 x 3cm	1.4 L	1 ea / 12 ea
f.	GPSS90 Rectangular, 25 x 17 x 4.5cm	1.5 L	1 ea / 12 ea
	GPSS120 Rectangular, 31 x 23.5 x 4.5cm	2.8 L	1 ea / 12 ea
PAILS			
g.	GTSS33 Round, 8cm dia x 8cm	265ml	1 ea / 12 ea
h.	GTSS44 Round, 11cm dia x 9.5cm	490ml	1 ea / 12 ea
i.	GTSS87 Round, 21cm dia x 18cm	4.7 L	1 ea / 4 ea
CADDY			
j.	GPSSCADDY Rectangular, 27.5 x 21 x 12cm	—	1 ea / 4 ea
FRY CUPS			
k.	GTSS28 Slanted Round, 8.5cm dia x 11.5cm	280ml	1 ea / 12 ea
	GTSS375 Slanted Round, 9.5cm dia x 12.5cm	295ml	1 ea / 12 ea
l.	GTSS31 Round, 9cm dia x 9cm	385ml	1 ea / 12 ea
	GTSS45 Round, 10cm dia x 12cm	680ml	1 ea / 12 ea
m.	GTSS4 Tapered Square, 10cm dia x 9.5cm	590ml	1 ea / 12 ea
RAMEKINS			
n.	GRSS1 Round, 6cm dia x 2.5cm	45ml	12 ea
o.	GRSS2 Round, 5.5cm dia x 4.5cm	75ml	12 ea
p.	GRSS3 Round, 7cm dia x 4.5cm	90ml	12 ea





THE LATTICE COLLECTION™

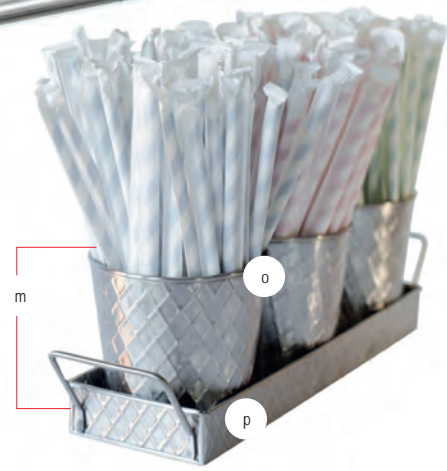

NEW



Item #	Description	Capacity	Min Order/ Case Pack
LATTICE COLLECTION™ – STAINLESS STEEL WITH EMBOSSED BASKETWEAVE PATTERN			
MUGS – 200 SERIES STAINLESS STEEL			
a.	11657 ▶ Round Mug, 12 x 8.5 x 9.5cm	400ml	1 ea / 12 ea
b.	11568 ▶ Round Mug, 13.5 x 10 x 10cm	700ml	1 ea / 12 ea
PLATTERS			
c.	10034 Round, 20.5 dia x 4cm	950ml	1 ea / 12 ea
d.	10035 Round, 26.5 dia x 4cm	1.9 L	1 ea / 12 ea
e.	10036 Oval, 24 x 15 x 5cm	1.2 L	1 ea / 12 ea
f.	10037 Oval, 30.5 x 23 x 5cm	3 L	1 ea / 12 ea
g.	10038 Rectangular, 24 x 16.5 x 4cm	1.5 L	1 ea / 12 ea
h.	10039 Rectangular, 30.5 x 23 x 4cm	2.8 L	1 ea / 12 ea
PAIL			
i.	10041 Round, 10 dia x 9.5cm	490ml	1 ea / 12 ea
FRY CUPS			
j.	10042 Slanted Round, 9.5 dia x 12cm	295ml	1 ea / 12 ea
k.	10043 Tapered Square, 10 x 10 x 9cm	590ml	1 ea / 12 ea
CADDY, SNACK SET & TRAY			
l.	10040 Rectangular, 27 x 21.5 x 12cm		1 ea / 4 ea
m.	10486 Four Piece Snack Set, Includes Tray (10488) & (3) 680ml Cups (10487)		1 ea / 12 ea
o.	10487 Round Cup, 10.5cm dia x 10.5cm	680ml	1 ea / 12 ea
p.	10488 Snack Tray, 36.5 x 11.5cm		1 ea / 12 ea

LATTICE ENTERTAIN YOU

- Create a casual dining experience with our Lattice Collection™ Stainless Steel construction with an embossed basketweave pattern
- Available in a variety of styles and sizes; these pieces add a casual feel to your main dishes and shareable sides

NEW



a / b / c



Paddle sizes range from individual to family-style serving

d / e / f



g



i



j

ACACIA COLLECTION™



- Bring rustic charm to your table setting with these handcrafted serving pieces
- Choose from a wide range of boards all made from attractive natural wood
- Prior to using, hand wash your item and protect it with a light coating of mineral oil

Item	Description	Min Order/ Case Pack
ACACIA WOOD WITH METAL BANDING		
a.	10076 Rectangular Paddle, 21 x 23cm with 12cm Handle	1 ea / 6 ea
b.	10077 Rectangular Paddle, 31 x 18cm with 12cm Handle	1 ea / 6 ea
c.	10078 Rectangular Paddle, 38.5 x 21.5cm with 12cm Handle	1 ea / 6 ea
d.	10079 Round Paddle, 25.5cm dia with 12cm Handle	1 ea / 6 ea
e.	10080 Round Paddle, 30.5cm dia with 12cm Handle	1 ea / 6 ea
f.	10081 Round Paddle, 35.5cm dia with 12cm Handle	1 ea / 6 ea



h

Nickel Plated Handles

Item	Description	Min Order/ Case Pack
ACACIA WOOD WITH BRUSHED NICKEL ACCENTS		
g.	ACAMBB1507 Display Bread Board with Metal Eyelet 38 x 18.5 x 1.5cm	1 ea / 12 ea
h.	ACAMR2007 Rectangular Display Board, 43 x 18 x 1.5cm with 3cm Handles	1 ea / 8 ea
i.	ACAMR14 Round Display Board, 35.5 x 1.5cm with 7.5cm Handle	1 ea / 6 ea
END GRAIN SERVING BOARDS		
j.	ACARD16 40.5cm dia x 4cm	1 ea / 3 ea

Harvested from nature; no two pieces are the same. Variation amongst sizes +/- 1.5cm

ACACIA COLLECTION™ SERVING BOARDS



SERVING SOLUTIONS
ACACIA COLLECTION™

Item #	Description	Min Order/ Case Pack
RECTANGULAR SERVING BOARDS		
11291	30.5 x 20.5 x 2cm	1 ea / 12 ea
a. 11294	35 x 24 x 2cm	1 ea / 12 ea
11295	45.5 x 30 x 2cm	1 ea / 6 ea
SERVING BREAD BOARDS WITH HANDLES		
b. 11296	24 x 24 x 2cm, with 11.5cm Handle	1 ea / 12 ea
c. 11297	26 x 18.5 x 2cm, with 15cm Handle	1 ea / 6 ea
ROUND & OVAL SERVING BREAD BOARDS		
d. 11298	23cm dia x 2cm	1 ea / 4 ea
e. 11299	30.5cm dia x 2cm	1 ea / 4 ea
f. 11300	40.5 x 20.5 x 2cm	1 ea / 6 ea
g. 11301	51 x 20.5 x 2cm	1 ea / 6 ea
SERVING PADDLE BOARDS		
11292	40 x 15.5 x 1.5cm, with 11cm Handle	1 ea / 8 ea
h. 11293	44 x 20.5 x 2cm, with 12cm Handle	1 ea / 8 ea

Harvested from nature; no two pieces are the same. Variation amongst sizes +/- 1.5cm





ACACIA COLLECTION™ SNACK TRAYS



Perfect for bread and cheeses, sliced pizzas or flatbreads, and other treats.

- Ergonomic handles for comfortable serving and hang hole for drying or storage
- Features recessed center to keep foods in place
- Conveniently packaged for Cash & Carry

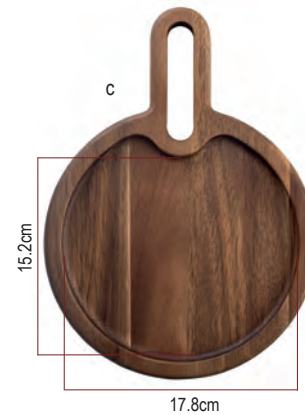

Item #	Description	Min Order/ Case Pack
ACACIA WOOD SNACK TRAYS		
a. 11522	Rectangular 23 x 14 x 2cm (7.5cm handle)	1 ea / 8 ea
b. 11523	Rectangular 30.5 x 14 x 2cm (7.5cm handle)	1 ea / 8 ea
c. 11524	Round 20.5cm dia x 2cm (7.5cm handle)	1 ea / 8 ea
d. 11525	Round 25.5cm dia x 2cm (9.5cm handle)	1 ea / 8 ea

Harvested from nature; no two pieces are the same. Variation amongst sizes +/- 1.5cm

Item #	Description	Min Order/ Case Pack
RECTANGULAR NATURAL DISPLAY BASKETS – POLYPROPYLENE		
a. 1188W	35.5 x 25.5 x 7.5cm	6 ea
1189W	41 x 28.5 x 7.5cm	6 ea
1192W	45.5 x 31 x 7.5cm	6 ea
NATURAL SERVING BASKETS – POLYPROPYLENE CASING, STEEL INTERIOR		
1175W	Round, 21.5cm dia x 5.5cm	12 ea
b. 1171W	Oval, 17.5 x 13 x 5cm	12 ea
1174W	Oval, 23 x 15 x 5.5cm	12 ea
1176W	Oval, 26 x 16.5 x 9cm	12 ea
c. 1177W	Round, 18cm dia x 5cm	12 ea

Item #	Description	Min Order/ Case Pack
RIDAL COLLECTION™ BASKETS – POLYETHYLENE, HEAVY SOLID CORD, BLACK		
d. M2475	Round, 21cm dia x 8cm	12 ea
e. M2474	Oval, 23.5 x 16 x 8cm	12 ea
M2485	Rectangular, 30 x 22 x 7.5cm	6 ea
f. M2489	Rectangular, 42 x 30 x 9cm	6 ea
g. M2493	Rectangular for Display, 48 x 35.5 x 10cm	6 ea
BROWN SERVING BASKETS – POLYETHYLENE, W/ENCASED STEEL SUPPORT WIRE		
1471	Oval, 18 x 13.5 x 5cm	12 ea
h. 1474	Oval, 23 x 15.5 x 6cm	12 ea
i. 1475	Round, 22cm dia x 6cm	12 ea

NATURAL BASKETS



- Solid, heavy cord design for superior quality
- All purpose serving baskets provide the "homemade" touch to your table setting



RIDAL COLLECTION™ BASKETS



- Solid, heavy cord design for superior quality
- Heat lamp and microwave safe up to 65°C
- Microwaveable for limited reheat use



FROM ARTISAN, TO PARISIAN.

ARTISAN COLLECTION™ BASKETS



- Integrated ramekin holders fit 2oz / 60ml and 3oz / 90ml ramekins (not included)



Item #	Description	Min Order/ Case Pack
ARTISAN COLLECTION™ BASKETS – BLACK POWDER COATED STEEL		
a. BK171182*	Round with Integrated Ramekin Holders, 28.5 x 21 x 5cm	1 ea / 6 ea
BK171372*	Oval with Integrated Ramekin Holders, 33.5 x 18.5 x 4.5cm	1 ea / 6 ea
b. BK171172*	Square with Integrated Ramekin Holders, 28.5 x 19.5 x 5cm	1 ea / 6 ea
BK17506	Round, 15cm dia x 5cm	1 ea / 6 ea
BK17508	Round, 20cm dia x 5.5cm	1 ea / 6 ea
c. BK17510	Round, 25.5cm dia x 7.5cm	1 ea / 6 ea
d. BK17409	Oval, 23.5 x 16 x 5.5cm	1 ea / 6 ea
BK17410	Oval, 25.5 x 17 x 8cm	1 ea / 6 ea
e. BK11709	Oblong, 23 x 10 x 5cm	1 ea / 6 ea
f. BK17209	Rectangular, 23.5 x 16 x 6cm	1 ea / 6 ea
PARISIAN COLLECTION™ BASKETS – BLACK POWDER COATED STEEL		
g. 10820	Round Wire Basket with Solid Bottom 15 x 15 x 5.5cm	1 ea / 24 ea
h. 10821	Round Wire Basket with Solid Bottom 20 x 20 x 6cm	1 ea / 24 ea
i. 10822	Oval Wire Basket with Solid Bottom 23 x 15 x 9cm	1 ea / 24 ea

*Ramekins Not Included



PARISIAN COLLECTION™ BASKETS



- Wire construction with solid bottoms for additional versatility



g



i



h

BLACK POWDER COATED METAL BASKETS

Providing an elegant and eye-catching way to serve bread and sides or display fruit and veggies.



BOUCLÉ COLLECTION™



Item #	Description	Min Order/ Case Pack
BOUCLÉ SERIES BASKETS – BLACK POWDER COATED STEEL		
a.	BK37109 Rectangular Basket, 20cm x 11cm (4cm depth)	1 ea / 6 ea
b.	BK37409 Oval Basket, 22cm x 14cm (5cm depth)	1 ea / 6 ea
c.	BK37508 Round Basket, 19cm dia (5cm depth)	1 ea / 6 ea
d.	BK37515 Round Basket, 15cm dia (5cm depth)	1 ea / 6 ea
DELTA SERIES BASKETS – BLACK POWDER COATED STEEL		
e.	10462 15cm dia Round Basket, (5cm depth)	1 ea / 6 ea
f.	10463 20cm dia Round Basket, (5cm depth)	1 ea / 6 ea
g.	10464 25.5cm dia Round Basket, (8.5cm depth)	1 ea / 6 ea
PETAL COLLECTION™ BASKETS – BLACK POWDER COATED METAL		
h.	10537 Rectangular, 22.5 x 15cm (6cm depth)	1 ea / 6 ea
i.	10534 Round, 15cm dia (6cm depth)	1 ea / 6 ea
j.	10535 Round, 20cm dia (5.5cm depth)	1 ea / 6 ea
k.	10536 Oval, 22.5 x 15cm (6cm depth)	1 ea / 6 ea

DELTA COLLECTION™



PETAL COLLECTION™

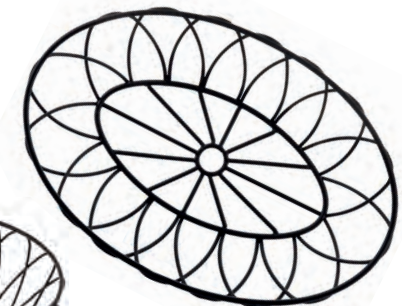



THE
CLASSIC.
OFTEN
REPLICATED...

OVAL PLASTIC BASKETS

- Heat lamp safe up to 65°C
- Max microwave 800 watts

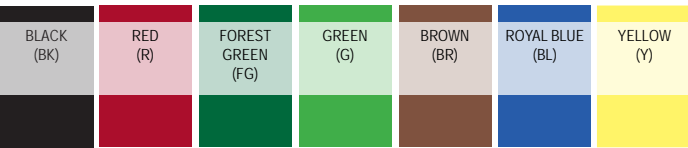

Item #	Description	Min Order/ Case Pack
CLASSIC OVAL BASKETS – HIGH DENSITY POLYPROPYLENE, 23.5 X 15.5 X 5CM		
1074BK	Black	36 ea
1074BK-6	Black, Pack of 6	1 pk / 6 pk
1074BL	Royal Blue	36 ea
1074BR	Brown	36 ea
1074FG	Forest Green	36 ea
1074G	Green	36 ea
a. 1074R	Red	36 ea
1074R-6	Red, Pack of 6	1 pk / 6 pk
1074Y	Yellow	36 ea
JUMBO OVAL BASKETS – POLYPROPYLENE, 30 X 23 X 5CM		
b. 1084BK	Black	36 ea
1084R	Red	36 ea
CHICAGO PLATTER OVAL BASKETS – POLYPROPYLENE, 27 X 18.5 X 3.5CM		
1076BK	Black	36 ea
c. 1076BR	Brown	36 ea
1076FG	Forest Green	36 ea
1076R	Red	36 ea
SIDE ORDER OVAL BASKETS – HIGH DENSITY POLYETHYLENE, 20 X 13.5 X 5CM		
1071BK	Black	36 ea
d. 1071R	Red	36 ea
TEXAS PLATTER OVAL BASKETS – POLYPROPYLENE, 32.5 X 24 X 4CM		
e. 1086BK	Black	36 ea
1086R	Red	36 ea

BASKETS AND PLATTERS

- Heat lamp safe up to 65°C
- Max microwave 800 watts



Item #	Description	Min Order/ Case Pack
A LA CARTE OVAL PLATTER BASKETS – POLYPROPYLENE, 23.5 X 15 X 4CM		
a. 1073BK	Black	36 ea
1073FG	Forest Green	36 ea
1073R	Red	36 ea
GRANDE RECTANGULAR PLATTER BASKETS – POLYPROPYLENE, 27 X 18.5 X 3.5CM		
b. 1077BK	Black	36 ea
1077BR	Brown	36 ea
1077R	Red	36 ea
MÁS GRANDE RECTANGULAR PLATTER BASKETS – POLYPROPYLENE, 30 X 21.5 X 4CM		
1079BK	Black	36 ea
c. 1079FG	Forest Green	36 ea
1079R	Red	36 ea
ROUND SERVING BASKETS – HIGH DENSITY POLYPROPYLENE, 20.5CM DIA X 5CM		
d. 1075BK	Black	36 ea
1075FG	Forest Green	36 ea
1075R	Red	36 ea
ROUND DINER PLATTERS WITH BASE – POLYPROPYLENE (NSF) 23CM DIA		
e. 15759BK	Black, 23cm dia x 4.5cm	12 ea
157510BK	Black, 26.5cm dia x 5.5cm	12 ea
157510R	Red, 26.5cm dia x 5.5cm	12 ea
ROUND PLATTERS – POLYPROPYLENE (NSF) 23CM DIA		
f. 13759BK	Black, 23cm dia x 3cm	12 ea



...BUT NEVER
DUPLICATED.

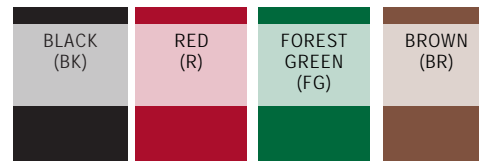



BRINGING IT ALL TO THE TABLE

Form follows function very closely when it comes to our serving tools for your dining room. Our tray stands and high chairs are made to last in colors and styles to match any decor. Our accessories will also enhance your guest's experience.



DINING ROOM TOOLS | 111

Wooden Tray Stands	111
Wooden Folding Crate Stands	111
Metal Tray Stands.....	112
Check Spindle	112
Call Bell	112
Table Crumber With Pocket Clip.....	112
High Chairs.....	113





b



d

STANDS
DELIVER

DINING ROOM WOODEN TRAYS STANDS

TRAY STANDS

- Rubber slip-proof top rings
- Tall tray stand reduces back strain and fatigue

Item #	Description	Min Order/ Case Pack
TRAY STANDS – WOOD MAHOGANY FINISH		
22	96.5 x 45.5 x 43cm	1 ea
a. 21	81.5 x 42 x 42cm	1 ea
TRAY STANDS – BLACK PAINTED WOOD FINISH		
b. 10399	81.5 x 42 x 42cm	1 ea



Now available
in black



FOLDING CRATE STANDS

Perfect for room service, breakfast in bed or as a riser on your serving presentation. Our new folding crate stands work with our 1/1 GN Crates (sold separately)

- Available in both Acacia and Black Painted Rubberwood
- 67.5 x 34 x 22cm (open)
- and 54.5 x 34 x 3cm (closed)
- Weight limit: 12kg

Item	Description	Min Order/ Case Pack
FOLDING CRATE STANDS FOR 1/1 GN CRATES-WOOD		
c. 10765	Folding Crate Stand, Acacia, 67.5 x 34 x 22 cm	1 ea / 4 ea
d. 10766	Folding Crate Stand, Black Painted Rubberwood, 67.5 x 34 x 22 cm	1 ea / 4 ea



Folds flat for
easy storage



HELPFUL HINT:

We do not recommend using folding crate stands to transport heavy items for display; position stand, add crate, and fill.



DINING ROOM METAL TRAY STANDS

Double Bar for added stability



Heavy tubular construction

TRAY STANDS

- Rubber slip-proof top rings
- Tall tray stand reduces back strain and fatigue

Item #	Description	Min Order/Case Pack
TRAY STANDS – CHROME PLATED OR BLACK POWDER COATED METAL		
23	Single Bar, Chrome Plated, 75.5 x 44 x 44cm	1 ea
a. 24	Double Bar, Chrome Plated, 80.5 x 46.5 x 42cm	1 ea
b. 23BK	Single Bar, Black, 75.5 x 44 x 44cm	1 ea
24BK	Double Bar, Black, 80.5 x 46.5 x 42cm	1 ea

ACCESSORIES ASSORTED



Item #	Description	Min Order/Case Pack
DINING ROOM ACCESSORIES		
c. 172	Check Spindle, Brass Plated, 9cm dia with 15cm spike	1 ea / 12 ea
d. 8381	Call Bell, Chrome Plated, 8.5cm dia x 6cm	1 ea / 12 ea
e. 518	Table Crumber, Gold Anodised Aluminium, 15cm	12 ea / 120 ea
f. 519	Table Crumber, Stainless Steel, 15cm	12 ea / 48 ea

HIGH CHAIRS

Keep your child seated safely with TableCraft's EU Compliant High Chairs. This simple, yet contemporary design is available in four colours to match any setting: black, white, natural & walnut finish. Durable, hardwood construction with washable replacement straps allows for easy cleaning with a damp cloth.

Our High Chairs comply with BS EN 14988:2017 Pt 1&2+A1:2020.

- Space saving, stackable design for easy storage
- Easy to clean with damp cloth, no food traps
- Adjustable 3-point waist strap harness
- Available in white, natural, walnut and black finishes
- Pre-assembled or flat packed

NEW

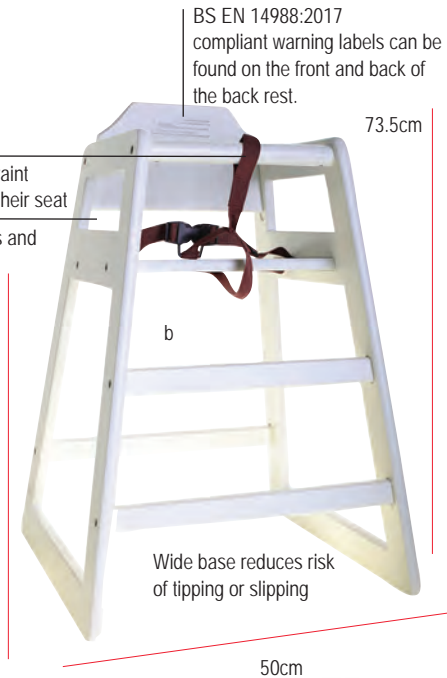

Item #	Description	Min Order/ Case Pack
BLACK		
61EU ▶	Unassembled, 50 x 50 x 73.5cm	1 ea
a. 61EUA ▶	Assembled, 50 x 50 x 73.5cm	1 ea
WHITE		
63EU	Unassembled, 50 x 50 x 73.5cm	1 ea
b. 63EUA	Assembled, 50 x 50 x 73.5cm	1 ea
NATURAL		
65EU	Unassembled, 50 x 50 x 73.5cm	1 ea
c. 65EUA	Assembled, 50 x 50 x 73.5cm	1 ea
WALNUT		
66EU	Unassembled, 50 x 50 x 73.5cm	1 ea
d. 66EUA	Assembled, 50 x 50 x 73.5cm	1 ea
REPLACEMENT PARTS & ACCESSORIES		
60EU	Black Replacement Strap, 35.5 x 3 x 2.5cm for 61EU	1 ea / 240 ea
67EU	Brown Replacement Strap, 35.5 x 3 x 2.5cm for 63EU, 65EU, 66EU	1 ea / 240 ea
*Due to volumetric freight restrictions, please call customer service to discuss freight options. 01536 400091		



A hand is shown squeezing a white plastic bottle with a blue top, dispensing a white dressing onto a salad in a white bowl. The salad consists of green lettuce, orange carrots, and golden-brown croutons. The background is a kitchen counter with various colorful bottles and a stove.

SQUEEZE AS YOU PLEASE!

A long-standing favourite of diners, sandwich shops and professional chefs around the world, our squeeze bottles are known for their superior quality. TableCraft offers a wide range of squeeze bottles with tops that can be modified to meet your operational needs.

SQUEEZE BOTTLE SIZE GUIDE | 116

Squeeze Bottle Guides & Accessories 116

INVERTATOP™ SQUEEZE BOTTLES | 150

Invertatop™ 53mm Squeeze Bottles 118

Invertatop™ 53mm Coloured End Caps 118

Invertatop™ 63MM Squeeze Bottles 118

Invertatop™ 63MM Coloured End Caps 118

WIDEMOUTH™ SQUEEZE BOTTLES | 152

Widemouth™ 53mm Squeeze Bottle 120

Widemouth™ 63mm Squeeze Bottle 120

DualWay™ Widemouth™

63MM Squeeze Bottle 121

DualWay™ Three Tiptop™ Selectop™

Widemouth™ 63MM Squeeze Bottles 121

Three Tiptop™ Selectop™ Widemouth™

63mm Squeeze Bottle 122

SaferFood Solutions™ Widemouth™

63MM Squeeze Bottle 122

SaferFood Solutions™ BBQ Brush 122

STANDARD SQUEEZE BOTTLES & ACCESSORIES | 123

Nostalgia Squeeze Bottles 123

Chef's Squeeze Bottles 123

Flip Top Cap Squeeze Bottles 123

Standard Squeeze Bottles 124

Squeeze Bottles Accessories 124

Forge Collection™ Squeeze Bottle Caddies 125

Squeeze Bottle Holders 125



View a video on all of the features and benefits of our 11253K-12 Squeeze Bottle



Scan code or go to our YouTube channel to watch our squeeze bottles video



Our squeeze bottles can be imprinted with your business or restaurant's one color logo. Contact your TableCraft Sales Representative for details.

SQUEEZE BOTTLE SOLUTIONS

53MM INVERTATOP™ VALVETOP™ SQUEEZE BOTTLES

NSF



12SV
12oz / 355ml bottle
standard stock



16SV
16oz / 475ml bottle
with SB53Y (band)

THE BLING IS THE THING

From prep to presentation, back of the house to the tabletop, TableCraft has the squeeze bottles and accessories to serve your customers quickly and easily, promote food safety and provide operators efficiency.

Colour End Caps and matching Silicone Bands are effective ways to identify Invertatop™ Bottle contents whether bottles are stored right side up or upside down.

63MM INVERTATOP™ VALVETOP™ SQUEEZE BOTTLES

NSF



24SV
24oz / 710 ml bottle
with 63FCAPLBL (cap)



32SV
32oz / 950ml bottle
with SB63LGN (band)
and 63FCAPLGN (cap)

Replacement Parts



53TSVN (Fits 53mm)
Valve & Top Assembly



53FCAP (Fits 53mm) End Cap



63FCAP (Fits 63mm) End Cap

Specialty Top



10162BK Basting Brush
(Fits 24SV Squeeze Bottles)

Replacement Tops



53TC (Fits 53mm)
Standard Cone Top



63TC (Fits 63mm)
Standard Cone Top



363TC (Fits 63mm)
Wide Cone Top

Coloured End Caps



Yellow = Y
53FCAPY (Fits 53mm)
63FCAPY (Fits 63mm)



Blue = BL
53FCAPBL (Fits 53mm)
63FCAPBL (Fits 63mm)



Red = R
53FCAPR (Fits 53mm)
63FCAPR (Fits 63mm)



Black = BK
53FCAPBK (Fits 53mm)
63FCAPBK (Fits 63mm)



Light Blue = LBL
53FCAPLBL (Fits 53mm)
63FCAPLBL (Fits 63mm)



Lime Green = LGN
53FCAPLGN (Fits 53mm)
63FCAPLGN (Fits 63mm)

Assorted Pack of 12
(2 each of colours shown to left)
53FCAPA (Fits 53mm)
63FCAPA (Fits 63mm)

Pack of single colour:
(12 each of one colour shown to left - add colour identification)
53FCAP_(Fits 53mm)
63FCAP_(Fits 63mm)

53MM WIDEMOUTH™ SQUEEZE BOTTLES



10853C – Standard Cone Tip
8oz / 240ml bottle
with SB53BK (band)



11253C – Standard Cone Tip
12oz / 355ml



11663C – Standard Cone Tip
16oz / 475ml bottle
31763C – WideMouth™ Cone
Tip with C100TA (red tip)



12463C – Standard Cone Tip
24oz / 710ml bottle
32563C – WideMouth™ Cone Tip
with SB63BL (band)



3263C – Standard Cone Tip
32oz / 950ml
63TC – WideMouth™ Cone Tip

Standard Cone
Tips–2.8mm Opening
Wide Cone Tips–4.2mm
Opening

Tethered Caps & Silicone Bands



C100TC – Standard Cone Tip, Natural
(Fits 53mm & 63mm)



C100TA – Standard Cone Tip,
Assorted Colours
(Fits 53mm & 63mm)



CASH & CARRY
PACKS available in
assorted colours only
(2 each of colour)
SB53A (Fits 53mm)
SB63A (Fits 63mm)



INVERTATOP™ SQUEEZE BOTTLES



b

Can be used as a storage cap for all 53mm bottles



END CAP COLOURS

YELLOW (Y)	BLUE (BL)	RED (R)	BLACK (BK)	LT. BLUE (LBL)	LT. GREEN (LGN)
----------------------	---------------------	-------------------	----------------------	--------------------------	---------------------------

TO ORDER END CAPS:

53FCAP Y

ITEM NUMBER Colour
*Leave blank for Natural

INVERTATOP™ 53MM SQUEEZE BOTTLES

- Easy-clean ValveTop™ works with fast-flow and slow-flow liquids, sauces and condiments; also allows for small particles (up to 3mm)
- Fill your bottle from the top and dispense from the bottom; ideal for busy food areas and minimises waste
- Coloured end caps provide easy identification (sold separately)



Item #	Description	Capacity	Min Order/ Case Pack
LDPE BOTTLE, 53MM HDPE CAP			
12SV	12oz Universal ValveTop™	355 ml	12 ea
a. 16SV	16oz Universal ValveTop™	475 ml	12 ea
*C12SV	12oz Universal ValveTop™ (6 per pack)	355 ml	8 pk
*C16SV	16oz Universal ValveTop™ (6 per pack)	475 ml	8 pk
REPLACEMENT PARTS & ACCESSORIES			
53TSVN	Valve & Top Assembly For NSF® InvertaTop™ Fits 53mm Bottles, Natural	—	12 ea
53FCAP	53mm End Cap, Natural	—	12 ea

*Available as Cash & Carry

INVERTATOP™ 53MM COLOURED END CAPS

- Coloured end caps provide easy identification



Item #	Description	Min Order/ Case Pack
HDPE CAP, 53MM		
b. *53FCAPA	53mm, Assorted, Pack of 12 (Includes 2 of each colour)	1 pk
REPLACEMENT PARTS & ACCESSORIES		
53FCAP_	53mm End Cap, Colour, Pack of 12	1 pk

INVERTATOP™ 63MM SQUEEZE BOTTLES

- Easy-clean ValveTop™ works with fast-flow and slow-flow liquids, sauces and condiments; also allows for small particles (up to 3mm)
- Fill your bottle from the top and dispense from the bottom; ideal for busy food areas and minimises waste
- Coloured end caps provide easy identification (sold separately)



Item #	Description	Capacity	Min Order/ Case Pack
LDPE BOTTLE, 63MM HDPE CAP			
	24SV 24oz Universal ValveTop™	710 ml	12 ea
a.	*C24SV 24oz Universal ValveTop™ (6 per pack)	710 ml	8 pk
b.	32SV 32oz Universal ValveTop™	950 ml	12 ea
REPLACEMENT PARTS & ACCESSORIES			
	63FCAP 63mm End Cap, Natural	—	12 ea

INVERTATOP™ 63MM COLOURED END CAPS

- Coloured end caps provide easy identification



Item #	Description	Min Order/ Case Pack
HDPE CAP, 63MM		
c.	*63FCAPA 63mm, Assorted (Includes 2 of each colour) Pack of 12	1 pk
REPLACEMENT PARTS & ACCESSORIES		
	63FCAP_ 63mm End Cap, Colour, Pack of 12	1 pk



Great for high viscosity, slow flowing condiments such as barbeque, mayonnaise and tartar!

Can be used as a storage cap for all 63mm bottles

TO ORDER THIS END CAP
63FCAP BL
ITEM NUMBER Colour
*Leave blank for Natural



WIDEMOUTH™ 53MM AND 63MM SQUEEZE BOTTLES

- Large opening for easy filling and cleaning
- Ideal option for fast preparation and service areas
- Available with either standard or wide cone tops



CUSTOM IMPRINTING available,
Contact your TableCraft sales rep
for a further details.



* CASH & CARRY
packaging

Item #	Description	Capacity	Min Order/ Case Pack
LDPE BOTTLE, 53MM POLYETHYLENE TOP			
10853K-12	8oz Ketchup, Red Top	240 ml	12 ea
10853M-12	8oz Mustard, Yellow Top	240 ml	12 ea
10853C-12	8oz Clear, Natural Top	240 ml	12 ea
C10853K*	8oz Ketchup, Red Top, Pack of 6	240 ml	12 pk
C10853M*	8oz Mustard, Yellow Top, Pack of 6	240 ml	12 pk
C10853C*	8oz Clear, Natural Top, Pack of 6	240 ml	12 pk
11253K-12	12oz Ketchup, Red Top	355 ml	12 ea
11253M-12	12oz Mustard, Yellow Top	355 ml	12 ea
11253C-12	12oz Clear, Natural Top	355 ml	12 ea
C11253K*	12oz Ketchup, Red Top, Pack of 6	355 ml	12 pk
C11253M*	12oz Mustard, Yellow Top, Pack of 6	355 ml	12 pk
C11253C*	12oz Clear, Natural Top, Pack of 6	355 ml	12 pk
REPLACEMENT PARTS & ACCESSORIES			
a.	53TBL 53mm Standard Cone Tip, Blue	—	12 ea
	53TC 53mm Standard Cone Tip, Natural	—	12 ea
	53TK 53mm Standard Cone Tip, Red	—	12 ea
	53TM 53mm Standard Cone Tip, Yellow	—	12 ea
LDPE BOTTLE, 63MM POLYETHYLENE TOP			
b.	11663K-12 16oz Ketchup, Red Top	475 ml	12 ea
c.	11663M-12 16oz Mustard, Yellow Top	475 ml	12 ea
d.	11663C-12 16oz Clear, Natural Top	475 ml	12 ea
	C11663C* 16oz Clear, Natural Top, Pack of 6	475 ml	8 pk
	12463K-12 24oz Ketchup, Red Top	710 ml	12 ea
	12463M-12 24oz Mustard, Yellow Top	710 ml	12 ea
	12463C-12 24oz Clear, Natural Top	710 ml	12 ea
	C12463K* 24oz Ketchup, Red Top, Pack of 6	710 ml	12 pk
	C12463M* 24oz Mustard, Yellow Top, Pack of 6	710 ml	8 pk
	C12463C* 24oz Clear, Natural Top, Pack of 6	710 ml	8 pk
e.	3263C 32oz Clear, Natural Top	950 ml	12 ea
	C3263C* 32oz Clear Natural Top, Pack of 6	950 ml	6 pk
REPLACEMENT PARTS & ACCESSORIES			
	63TC 63mm WideMouth™ Cone Tip, Natural	—	12 ea
	63TK 63mm WideMouth™ Cone Tip, Red	—	12 ea
	63TM 63mm WideMouth™ Cone Tip, Yellow	—	12 ea

Item #	Description	Capacity	Min Order/ Case Pack
LDPE BOTTLE, 63MM POLYPROPYLENE TOP			
a. 31763C	16oz Clear, Natural Top	475 ml	24 ea
32563C	24oz Clear, Natural Top	710 ml	12 ea
REPLACEMENT PARTS & ACCESSORIES			
363TC	63mm Wide Tip Cone, Natural	—	12 ea
LDPE BOTTLE, 63MM HDPE CAP			
11663CF	16oz Clear, Cone Tip, Natural Top	475 ml	12 ea
b. 12463CF	24oz Clear, Cone Tip, Natural Top	710 ml	12 ea
REPLACEMENT PARTS & ACCESSORIES			
63TC	63mm, Cone Tip, Natural	—	12 ea
63FCAP_	63mm End Cap, Colour, Pack of 12	—	1 pk
LDPE BOTTLE, 63MM HDPE CAP			
c. 11663C3F	16oz Clear, Natural Three Tiptop™ SelecTop™	475 ml	12 ea
12463C3F	24oz Clear, Natural Three Tiptop™ SelecTop™	710 ml	12 ea
REPLACEMENT PARTS & ACCESSORIES			
63TC3	63mm, Three Tiptop™ SelecTop™, Natural	—	12 ea
63FCAP	63mm End Cap, Natural	—	12 ea

DUALWAY™ THREE TIPTOP™ SELECTOP™ WIDEMOUTH™ 63MM SQUEEZE BOTTLES



c



WIDEMOUTH™ 63MM SQUEEZE BOTTLE

- Wide cone tip



SQUEEZE BOTTLE SOLUTIONS
WIDEMOUTH™ DUALWAY™ & SELECTOP™



DUALWAY™ WIDEMOUTH™ 63MM SQUEEZE BOTTLES

- Innovative bottle uses leakproof PerfectFlex™ for rapid food preparation
- Fill your bottle from the bottom and dispense from the top



SAFERFOOD SOLUTIONS™ BOTTLES



a



c



d

e

f

SAFERFOOD SOLUTIONS™ WIDEMOUTH™

63MM SQUEEZE BOTTLE

- Easy-clean solution, suitable for all sauces
- Allows for increased efficiency and food preparation management

Item #	Description	Capacity	Min Order/ Case Pack
LDPE BOTTLE, 63MM HDPE CAP			
a.	N20C	20oz Clear, Natural Top	590 ml 12 ea

SAFERFOOD SOLUTIONS™ BBQ BRUSH & DISPENSING SYSTEM

- For dispensing and brushing dressings
- Brush is made from heat-safe silicone

Item #	Description	Min Order/ Case Pack
LDPE BOTTLE, HDPE CAP WITH SILICONE BRUSH		
b.	10162BK BBQ Brush Only, Black (fits 24SV Squeeze Bottle)	12 ea
c.	10727 BBQ Brush and 24oz / 710ml Invertatop™ Squeeze Bottle (24SV) Set	12 ea

THREE TIPTOP™ SELECTOP™ WIDEMOUTH™

63MM SQUEEZE BOTTLE

- Three tips for even dispensing

Item #	Description	Capacity	Min Order/ Case Pack
LDPE BOTTLE, 63MM POLYPROPYLENE TOP			
d.	11663C3	16oz Clear, Natural Top	475 ml 12 ea
e.	12463C3	24oz Clear, Natural Top	710 ml 12 ea
f.	3263C3	32oz Clear, Natural Top	950 ml 12 ea
REPLACEMENT PARTS & ACCESSORIES			
63TC3	63mm, Three Tiptop™ SelecTop™, Natural	—	12 ea

ADD SOME SPECIAL SAUCE

Item #	Description	Capacity	Min Order/ Case Pack
NOSTALGIA SQUEEZE BOTTLES – LDPE BOTTLE, 38MM POLYPROPYLENE TOP			
1112C	12oz Clear, Cone Tip, Natural Top	355 ml	12 ea
1112K	12oz Red, Cone Tip, Red Top	355 ml	12 ea
1112M	12oz Yellow, Cone Tip, Yellow Top	355 ml	12 ea
a. *1112KMC	3 pc Set, (1) 1112K, (1) 1112M, (1) 1112C	(3) 355 ml	12 ea
CHEF'S SQUEEZE BOTTLES – LDPE BOTTLE, HDPE CAP			
1102	2oz Clear, Natural Top	60 ml	24 ea
1104	4oz Clear, Natural Top	120 ml	24 ea
b. *H110204	Bottle Set, Clear, Carded (1) 1102 & (1) 1104, 2 & 4 oz	60 ml & 120 ml	6 ea
FLIP TOP CAP SQUEEZE BOTTLES – LDPE BOTTLE, 38MM POLYPROPYLENE TOP			
c. 2132C	32oz Clear with White Hinged Cap	950 ml	12 ea

NOSTALGIA SQUEEZE BOTTLES

- Adds retro flair with the classic 1950s graphic design
- Great for front-of-house service



CHEF'S SQUEEZE BOTTLES



FLIP TOP CAP SQUEEZE BOTTLES

- Flip-top cap offers a cleaner and fresher service solution
- Perfect for catering and take away service



A PLACE FOR EVERYTHING...



a



b



c



d



e



11663C-12 Standard Cone Tip
16oz / 475ml bottle
31763C - Widemouth™ Cone Tip
with C100TA (red tip)



f



g



h

STANDARD SQUEEZE BOTTLES



Item #	Description	Capacity	Min Order/ Case Pack
STANDARD SQUEEZE BOTTLES – CLEAR LDPE BOTTLE, 38MM POLYPROPYLENE TOP			
a.	32C 32oz Wide Cone Tip, Natural Top	950 ml	12 ea
REPLACEMENT PARTS & ACCESSORIES			
b.	100TC 38mm Standard Cone Tiptop™, Natural	—	12 ea
c.	100TK 38mm Standard Cone Tiptop™, Red	—	12 ea
d.	100TM 38mm Standard Cone Tiptop™, Yellow	—	12 ea

ACCESSORIES



Item #	Description	Min Order/ Case Pack
ACCESSORIES		
e.	*SB53A Assorted Silicone Sauce Bands for 53mm bottles (Includes 2 of each colour) Pack of 12	1 pk / 12 pk
	*SB63A Assorted Silicone Sauce Bands for 63mm bottles (Includes 2 of each colour) Pack of 12	1 pk / 12 pk
f.	C100TC Squeeze Bottle Tethered Cap, Natural (12 per Pack)	1 pk
g.	C100TA Squeeze Bottle Tethered Cap, Assorted Colours (Includes 2 of each Yellow, Blue, Red, Black, Light Blue, Light Green)	1 pk
h.	C100TBK Squeeze Bottle Tethered Cap, Black (12 per Pack)	1 pk

AND EVERYTHING IN ITS PLACE

SQUEEZE BOTTLE HOLDERS & GASTRONORM ORGANISERS



Item #	Description	Min Order/ Case Pack
FORGE COLLECTION™ SQUEEZE BOTTLE CADDIES - BLACK GALVANISED STEEL		
a. 11846 ▶	Holds (4) 63 mm diameter bottles, 18.5 x 18 x 17cm,	1 ea / 18 ea
b. 11847 ▶	Holds (6) 63 mm diameter bottles, 23 x 18.5 x 17cm	1 ea / 12 ea
SQUEEZE BOTTLE GASTRONORM ORGANISERS - STAINLESS STEEL		
c. SQH6	Holds up to (6) 63mm diameter bottles, 33.5 x 18 x 11.5cm	1 ea / 6 ea
d. SQH8	Holds up to (8) 63mm diameter bottles, 33.5 x 18 x 11.5cm	1 ea / 6 ea
e. T4	Holds up to (4) 53mm diameter bottles (18 x 16cm) fits 1/6 size gastronorm food pan	1 ea / 12 ea
f. T6	Holds up to (6) (12oz / 355ml, 16oz / 475ml, 24oz / 710ml) 63mm diameter bottles (32.5 x 18cm) fits 1/3 size gastronorm food pan	1 ea / 12 ea
g. T8	Holds up to (8) (12oz / 355ml or 16oz / 475ml) 53mm diameter bottles (32.5 x 18cm) fits 1/3 size gastronorm food pan	1 ea / 12 ea

NEW

See the rest of our Forge Collection™ on page 21

New Forge Collection™ Squeeze Bottle Caddies in black galvanised steel with a mango wood handle bring rustic style to your tabletop



Caddies hold 16 & 24 oz (63 mm) bottles

Rustic style caddies in black galvanised steel

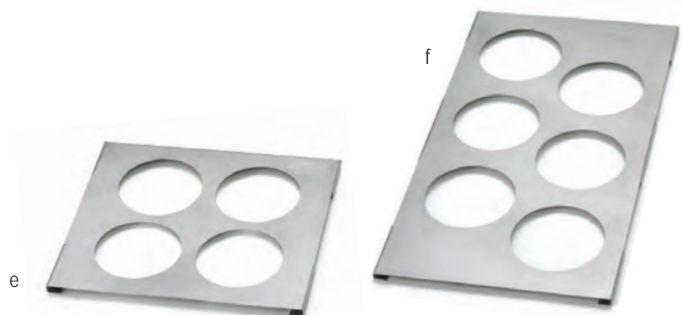
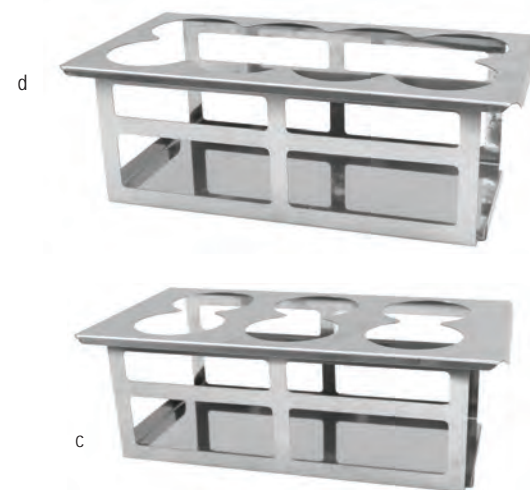

SQUEEZE BOTTLE SOLUTIONS
STANDARD BOTTLES & ACCESSORIES

TOOLS OF THE TRADE

TableCraft's commercial kitchen supplies provide all the elements to keep your kitchen running smoothly and efficiently. From prep to plate, our selection of food prep and kitchen supplies will help minimise waste, offer portion control, save time and adhere to food safety guidelines.



FOOD PREP TOOLS & GADGETS | 128

Perfectgrip™ Utensils.....	128
Cut-Resistant Gloves.....	129
Mixing Bowls.....	131
Footed Colanders.....	131
High Heat Spoons & Spatulas.....	131
Low Heat Spoons & Spatulas.....	131
Wooden Spoons.....	131
Piano & French Whips.....	132
Kettle Whip.....	132
Icing Spatulas.....	133
Dredges.....	133
Screen Sifters.....	133
One-Piece Ladles.....	134
Utility Tongs.....	134
Ergonomic Locking Tongs.....	134
Vinyl Coated Tongs.....	135
Silicone Tip Tongs.....	135
Antimicrobial Tongs.....	135
Basting Spoons.....	136
Flexible Measuring Cups.....	137
Premium Measuring Cups.....	137
Heavyweight Measuring Spoons & Cups.....	137
Thumb Press Dishers.....	138
Measuring Ladles.....	140
Measuring Spoons.....	140
Pizza Screen.....	141
One-Piece Spoonouts.....	142
Silicone & Stainless Steel Utensils.....	142
High Heat Tools.....	143
Food Turners & Utensils.....	144

CUTTING BOARDS & ACCESSORIES | 145

Grippy Cutting Boards.....	145
Cutting Boards.....	145
Flexible Cutting Boards.....	145
Cutting Board Racks.....	146
PerfectGrip® Knife Sharpener.....	146
Knife Rack.....	146
Magnetic Knife Holders.....	146
Skewers.....	147

Graters.....	147
Crinkle Cut Mezzaluna.....	147

KITCHEN SUPPLIES & EQUIPMENT | 148

Burrito/Taco Fry Baskets.....	148
Taco Bowl Fry Baskets.....	148
Prep Trays, Rails.....	148
Taco Tostada Fry Baskets.....	148
Fryer Baskets.....	149
Pasta Baskets.....	149
French Fry Scoops.....	149
Prep Tray Rails.....	149
Potato Mashers.....	150
Kettle Whips.....	150
Skimmers.....	150
Double Mesh Strainers.....	150
Single Mesh Strainers.....	150
Strainers.....	150
4 Egg Ring.....	151
Meat Tenderisers.....	151
Steak Weights.....	151
Kenkut® 3 Film or Foil Dispenser.....	153
Griddle Stones.....	154
Heavy Duty Grill Scraper.....	154
Order Holder.....	155
Funnels.....	155

FLATWARE HOLDERS | 156

Flatware Cylinders & Tiered Holders.....	156
Cutlery Bins.....	156

CONDIMENT DISPENSERS & PUMPS | 157

NSF® Option™ Dispensers.....	157
LDPE Bottles.....	157
HDPE Jugs.....	157
Storage Caps.....	157

NEW



Improved Hang Hole



Packaged for Cash & Carry.



Peelers have built-in potato eyer

PERFECTGRIP™ UTENSILS

• Patented ergonomic soft grip, non-slip handles for comfort and safety



Item	Description	Min Order / Case Pack
PERFECTGRIP™ UTENSILS		
a.	10973 ▶ Paring Knife	1 ea / 12 ea
b.	10974 ▶ Double Pastry Cutter	1 ea / 12 ea
c.	10975 ▶ Oyster Shucker	1 ea / 12 ea
d.	10976 ▶ Small Slotted Spatula	1 ea / 12 ea
e.	10977 ▶ "Y" Peeler, Julienne Edge	1 ea / 12 ea
f.	10978 ▶ Grater, Small Holes	1 ea / 12 ea
g.	10979 ▶ Grater/Zester	1 ea / 12 ea
h.	10980 ▶ Straight Peeler, Serrated Edge	1 ea / 12 ea
i.	10981 ▶ Cheese Plane	1 ea / 12 ea
j.	10982 ▶ Melon Baller	1 ea / 12 ea
k.	10983 ▶ Grater, Medium Holes	1 ea / 12 ea
l.	10984 ▶ Grater, Large Holes	1 ea / 12 ea
m.	10985 ▶ Apple Corer	1 ea / 12 ea
n.	10986 ▶ Ice Cream Disher**	1 ea / 12 ea
o.	10987 ▶ Y Peeler, Serrated Edge	1 ea / 12 ea
p.	10989 ▶ Garlic Press	1 ea / 12 ea
q.	10990 ▶ Zester/Lemon Peeler	1 ea / 12 ea
r.	10991 ▶ Tomato Stem Corer	1 ea / 12 ea
s.	10992 ▶ Pizza Cutter Wheel	1 ea / 12 ea
t.	10993* ▶ Can Opener**	1 ea / 12 ea
u.	10994 ▶ Handheld Sharpener	1 ea / 12 ea
v.	10995 ▶ Kitchen Shears	1 ea / 12 ea
w.	10996 ▶ "Y" Peeler, Straight Edge	1 ea / 12 ea
x.	10997 ▶ Straight Peeler, Straight Edge	1 ea / 12 ea

*Not NSF listed † Handwash Only



GLOVE SIZING GUIDE

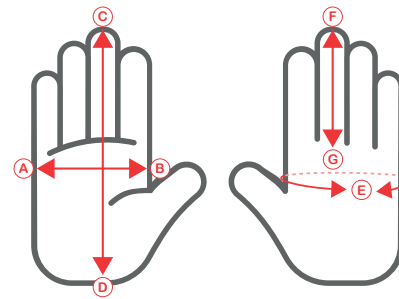

Item #	Glove Size	Palm Width		Hand Length		Palm Circumference		Finger Length	
		Inches	Millimeters	Inches	Millimeters	Inches	Millimeters	Inches	Millimeters
11207	XS	2½ - 2¾	63 - 73	6 - 6½	152 - 165	6 - 7	152 - 178	3 - 3¼	76 - 83
11208	S	2¾ - 3¼	73 - 83	6½ - 7	165 - 178	7 - 8	178 - 203	3¼ - 3½	83 - 89
11209	M	3¼ - 3¾	83 - 92	7 - 7½	178 - 191	8 - 9	203 - 229	3½ - 3¾	89 - 95
11210	L	3¾ - 4	92 - 102	7½ - 8	191 - 203	9 - 10	229 - 254	3¾ - 4	95 - 102
11211	XL	4 - 4¾	102 - 112	8 - 8½	203 - 216	10 - 11	254 - 280	4 - 4¼	102 - 108

If you are between sizes – size down for a snug fit.

CUT-RESISTANT GLOVES



Protect your back of house team against potential lacerations with our new Cut-Resistant Gloves.

- Seamless weave, ambidextrous design for comfort and safety
- Extended cuff protects the wrist and holds glove in place
- ANSI cut level 6
- Made of HPPE (High Performance Polyethylene), Stainless Steel, spandex, and polyester
- Sold as a pair



Item #	Description	Min Order/ Case Pack
CUT-RESISTANT GLOVES (PAIR)		
a. 11207	X-Small, Black with Red Cuff, Polyethylene	1 pair / 12 pairs
b. 11208	Small, Black with Yellow Cuff, Polyethylene	1 pair / 12 pairs
c. 11209	Medium, Black with Green Cuff, Polyethylene	1 pair / 12 pairs
d. 11210	Large, Black with Blue Cuff, Polyethylene	1 pair / 12 pairs
e. 11211	X-Large, Black with Black Cuff, Polyethylene	1 pair / 12 pairs

MIXING IT UP



Item #	Description	Capacity	Min Order/ Case Pack
MIXING BOWLS – STAINLESS STEEL, MIRROR FINISH, 0.4MM			
	822	16.5cm dia x 5cm	850ml 1 ea / 12 ea
a.	823	20cm dia x 6cm	1.7 L 1 ea / 12 ea
b.	824	25.5cm dia x 8cm	2.1 L 1 ea / 12 ea
	825	27cm dia x 9cm	3.1 L 1 ea / 12 ea
	826	30cm dia x 8cm	3.6 L 1 ea / 24 ea
c.	827	33.5cm dia x 10.5cm	5.3 L 1 ea / 12 ea
	828	41cm dia x 12cm	9.5 L 1 ea / 12 ea
	830	48cm dia x 15cm	17.6 L 1 ea / 12 ea
FOOTED COLANDER WITH HANDLES – STAINLESS STEEL, 200 SERIES			
	705	35.5cm x 30cm x 12cm	— 1 ea / 12 ea
	708	40.5cm x 33.5cm x 13cm	— 1 ea / 12 ea
FOOTED COLANDER – STAINLESS STEEL, MIRROR FINISH, 0.4MM			
d.	713	41.5cm dia x 15cm, 49.5cm Width with Handle	12.3 L 1 ea / 12 ea
HIGH HEAT SPOONS/SPATULAS – SILICONE & NYLON			
e.	1865	Spoon Spatula, 26.5cm	— 1 ea / 6 ea
	1866	Spoon Spatula, 35.5cm	— 1 ea / 6 ea
	1867	Spoon Spatula, 41.5cm	— 1 ea / 6 ea
	1862	Spatula, 26.5cm	— 1 ea / 24 ea
	1863	Spatula, 35.5cm	— 1 ea / 24 ea
f.	1864	Spatula, 41.5cm	— 1 ea / 24 ea
LOW TEMP SPOON / SPATULAS – EVA WITH HIGH IMPACT POLYSTYRENE HANDLE			
g.	2510	Spoon Shaped Spatula, 24cm	— 24 ea
	2514	Spoon Shaped Spatula, 35.5cm	— 24 ea
	2516	Spoon Shaped Spatula, 42cm	— 12 ea
	1500	Flat Blade Spatula, 24cm	— 24 ea
	1510	Flat Blade Spatula, 25.5cm	— 24 ea
	1514	Flat Blade Spatula, 35.5cm	— 24 ea
h.	1516	Flat Blade Spatula, 40.5cm	— 24 ea
WOODEN SPOONS – BEECHWOOD			
	W12	30.5cm	— 12 ea
i.	W14	35.5cm	— 12 ea
	W16	40.5cm	— 12 ea
	W18	45.5cm	— 12 ea

Actual capacity may be slightly less than trade capacity

MIXING BOWLS AND COLANDERS

- Blend, mix, whip and prep ingredients with these durable mixing bowls in Stainless Steel
- Our footed collanders are perfect for rinsing fruits and vegetables, draining pastas, etc.



HIGH HEAT SPOONS / SPATULAS

- Durable flexible design is perfect for prepping and scraping
- Heat resistant to 260°C
- Available in a variety of sizes



BPA FREE



LOW TEMP SPOONS / SPATULAS

- Heat resistant to 60°C



BPA FREE



WOODEN SPOONS



WHIP IT

PIANO & FRENCH WHIPS

A necessity for back of the house food prep. Perfect for mixing and whipping up sauces, toppings, batters and more! Available in a variety of sizes to suit your needs.

- Durable Stainless Steel construction
- Sealed wires for easy cleaning
- Easy to clean, dishwasher safe



French Whips:
denser wires with a more elongated shape – perfect for mixing emulsions, sauces and batters.



Piano Whips:
thin wires that form a wide rounded balloon shape – great multi-purpose whip for beating egg whites, heavy cream, or other thin liquids.



KETTLE WHIP



Item #	Description	Min Order/ Case Pack
FRENCH WHIPS – STAINLESSS STEEL		
16 SEALED WIRES, 2MM WIRE GAUGE		
SF10	26cm	1 ea / 12 ea
SF12	30.5cm	1 ea / 12 ea
a. SF14	35.5cm	1 ea / 12 ea
SF16	40.5cm	1 ea / 12 ea
SF18	45.5cm	1 ea / 12 ea
b. SF20	51cm	1 ea / 12 ea
SF24	61cm	1 ea / 12 ea
PIANO WHIPS – STAINLESSS STEEL		
24 SEALED WIRES, 1.2MM WIRE GAUGE		
SP10	25.5cm	1 ea / 12 ea
SP12	30.5cm	1 ea / 12 ea
c. SP14	35cm	1 ea / 12 ea
SP16	40.5cm	1 ea / 12 ea
KETTLE WHIPS – STAINLESS STEEL		
d. MW40	12.5cm dia, 101.5cm Length	1 ea / 12 ea

SHAKE AND SEASON

DREDGES



Item #	Description	Capacity	Min Order/ Case Pack
DREDGE – ALUMINIUM			
a.	H158 Dredge with handle (1.8mm holes)	295ml	12 ea
DREDGE – STAINLESS STEEL			
b.	159 Dredge (1.8mm holes)	295ml	1 ea / 12 ea
c.	H159 Dredge with handle (1.8mm holes)	295ml	1 ea / 12 ea
DREDGE – PLASTIC			
d.	166A Dredge with Salt & Pepper Lid, Beige	295ml	12 ea
e.	166C Dredge with Medium Ground Lid, Rose	295ml	12 ea
f.	166D Dredge with Cheese Lid, Yellow	295ml	12ea
	166F 3pc Dredge Set. 1 ea with Beige, Rose & Yellow Lids, Polybagged	(3) 295ml	12 ea
TRIPLE SCREEN SIFTER – STAINLESS STEEL			
g.	H2997BH 5 Cup	1.1 L	6 ea

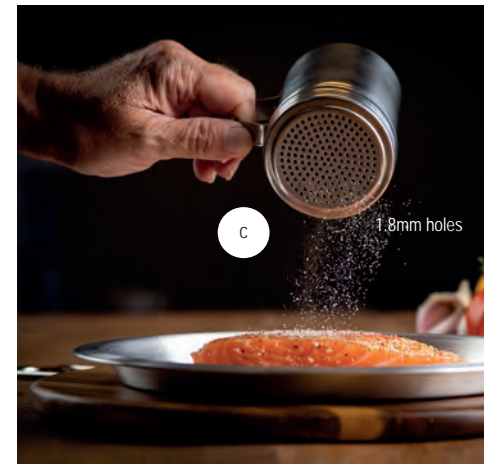

SCREEN SIFTER

Triple screen for finer flour (1.8mm holes)



ICING SPATULAS



Item #	Description	Min Order/ Case Pack
ICING SPATULAS – STAINLESS STEEL W/ WHITE POLYPROPYLENE HANDLE		
h.	4206 15cm Blade	1 ea / 12 ea
i.	4208 20.5cm Blade	1 ea / 12 ea
j.	4210 25.5cm Blade	1 ea / 12 ea
k.	4212 30.5cm Blade	1 ea / 12 ea
l.	4214 35.5cm Blade	1 ea / 12 ea



ONE-PIECE LADLES



Perfect for portion control, prepping and serving! Available in a variety of sizes to suit your needs. Built in hook for easy hanging and storing.

- Durable Stainless Steel One-Piece Construction
- Capacity markings listed on handle (oz/ml)
- Easy to clean, dishwasher safe



UTILITY TONGS



ERGONOMIC LOCKING TONGS



- Integrated silicone comfort grips



BASTING SPOONS



Item #	Description	Capacity	Min Order/ Case Pack
ONE-PIECE LADLE – STAINLESS STEEL, 0.9 MM			
a.	4701 1oz 5.5 x 10.5 x 30.5cm	30ml	1 ea / 12 ea
b.	4702 2oz 7 x 12 x 32cm	60ml	1 ea / 12 ea
c.	4703 3oz 37.5 x 12.5 x 35.5cm	90ml	1 ea / 12 ea
d.	4704 4oz 8.5 x 13.5 x 35.5cm	120ml	1 ea / 12 ea
e.	4706 6oz 9.5 x 14.5 x 37cm	180ml	1 ea / 12 ea
f.	4708 8oz 10.5 x 14.5 x 37.5cm	240ml	1 ea / 12 ea
g.	4712 12oz 12.5 x 17.5 x 39.5cm	355ml	1 ea / 12 ea
UTILITY TONGS – STAINLESS STEEL, WITH SPRING HINGE HEAVYWEIGHT 1.2MM			
2774	24 x 3.5 x 2cm		1 ea / 12 ea
2712	30 x 7 x 2.5cm		1 ea / 12 ea
2716	40.5 x 3 x 2cm		1 ea / 12 ea
STANDARD 0.7MM			
h.	74 24 x 4 x 4cm		12 ea
i.	712 30 x 3 x 2cm		12 ea
j.	716 40.5 x 1 x 3cm		12 ea
ERGONOMIC LOCKING TONGS – STAINLESS STEEL, 0.8MM, SILICONE			
k.	2009 23 x 4 x 4cm		12 ea
l.	2012 34.5 x 4 x 3cm		12 ea
m.	2016 3 x 4 x 39cm		12 ea
STAINLESS STEEL BASTING SPOON, 1.2MM			
n.	3711 28 x 6.5 x 2.5cm	35ml	12 ea
	3715 38 x 6.5 x 2.5cm	35ml	12 ea

Item #	Description	Min Order/ Case Pack
ANTIMICROBIAL ONE-PIECE SERVING TONG, VINYL COATED HANDLE – STAINLESS STEEL		
a. AM3709BL	23 x 4 x 2.5cm, Blue Handle	1 ea / 6 ea
AM3709G	23 x 4 x 2.5cm, Green Handle	1 ea / 6 ea
ANTIMICROBIAL V-HINGE SERVING TONG, VINYL COATED HANDLE – STAINLESS STEEL		
AM3716BK	41.5 x 4 x 4.5cm, Black Handle	1 ea / 12 ea
b. AM3716G	41.5 x 4 x 4.5cm, Green Handle	1 ea / 12 ea
AM3716Y	41.5 x 4 x 4.5cm, Yellow Handle	1 ea / 12 ea
COLOUR-CODED VINYL HANDLE, V-HINGE TONGS – STAINLESS STEEL		
c. 3774BKEU	24.5 x 4 x 3cm, Black Handle	1 ea / 12 ea
d. 3774BLEU	24.5 x 4 x 3cm, Blue Handle	1 ea / 12 ea
e. 3774GEU	24.5 x 4 x 3cm, Green Handle	1 ea / 12 ea
f. 3774REU	24.5 x 4 x 3cm, Red Handle	1 ea / 12 ea
g. 3774YEU	24.5 x 4 x 3cm, Yellow Handle	1 ea / 12 ea
3712BKEU	31.5 x 4 x 3cm, Black Handle	1 ea / 12 ea
3712BLEU	31.5 x 4 x 3cm, Blue Handle	1 ea / 12 ea
3712GEU	31.5 x 4 x 3cm, Green Handle	1 ea / 12 ea
3712REU	31.5 x 4 x 3cm, Red Handle	1 ea / 12 ea
3712YEU	31.5 x 4 x 3cm, Yellow Handle	1 ea / 12 ea
3716BKEU	41.5 x 3.81 x 4.5cm, Black Handle	1 ea / 12 ea
3716BLEU	41.5 x 3.81 x 4.5cm, Blue Handle	1 ea / 12 ea
3716GEU	41.5 x 3.81 x 4.5cm, Green Handle	1 ea / 12 ea
3716REU	41.5 x 3.81 x 4.5cm, Red Handle	1 ea / 12 ea
3716YEU	41.5 x 3.81 x 4.5cm, Yellow Handle	1 ea / 12 ea
SILICONE TIP LOCKING TONGS – STAINLESS STEEL, 0.8MM		
h. 4009BK	26.5 x 4.5 x 3cm	12 ea / 12 ea
4012BK	34.5 x 4.5 x 2.5cm	12 ea / 12 ea
4016BK	40.5 x 4 x 2cm	12 ea / 12 ea

ANTIMICROBIAL TONGS

- Perfect for serving in the front or back of the house
- Cool-touch, antimicrobial Microban® handle for safe and sanitary use, promotes food safety and reduces the risk of contamination
- Dishwasher safe for temperatures up to 100°C

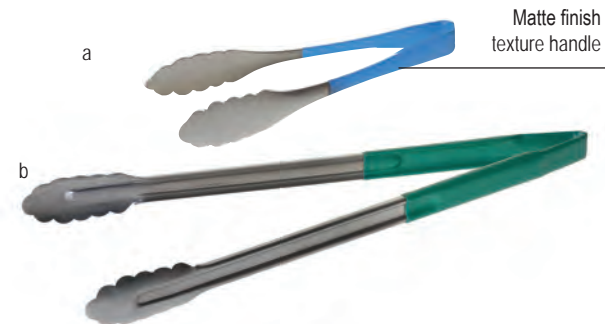

Matte finish
texture handle

VINYL-COATED TONGS



- Colour-coded to help prevent cross contamination

SILICONE TIP LOCKING TONGS



- Heat resistance up to 232°C

MEASURING TOOLS

A full range to help you with every measuring need in the kitchen



SILICONE MEASURING CUPS



Lined measurements in cups, ounces and milliliters

3-sided design makes these cups easy to hold while pouring



a

MEASURING CUPS & SPOONS



b

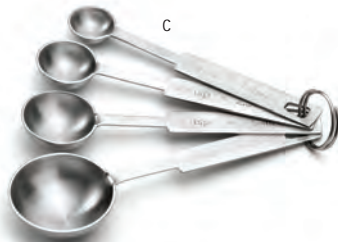

c



d



e



Item #	Description	Capacity	Min Order/ Case Pack
FLEXIBLE MEASURING CUPS – SILICONE			
a.	*HSMC3 Set of 3 Includes: 1 Cup, 2 Cup, 4 Cup	250ml 500ml 1 L	1 ea / 6 ea
PREMIUM MEASURING SETS – ONE-PIECE STAINLESS STEEL			
b.	725 4-Pc Set Includes: ¼ Cup, ½ Cup, ½ Cup, 1 Cup	60ml 80ml 125ml 250ml	1 ea / 12 ea
HEAVYWEIGHT & STANDARD MEASURING SPOONS & CUPS – STAINLESS STEEL			
c.	722 Heavyweight, 4-Pc Set Includes: ¼ tsp, ½ tsp, 1 tsp, 1 tbsp	1ml 2.5ml 5ml 15ml	1 ea / 12 ea
d.	724 4-pc Cup Set Includes: ¼, ½, ½, 1 Cup	60ml 80ml 125ml 250ml	1 ea / 12 ea
e.	40401 1 tbsp Long Handled Spoon, 22cm	15ml	1 ea / 12 ea
	40402 2 tbsp Long Handled Spoon, 23cm	30ml	1 ea / 12 ea



Cash & Carry
Packaging

THUMB PRESS DISHERS

- Specially sized scoops, ideal for portion control
- Choose from a range of sizes, colour-coded to indicate capacity



Item #	Description	Color	Capacity	Min Order
THUMB PRESS DISHERS – 18/8 STAINLESS STEEL, POLYETHYLENE HANDLE				
a. 2108	Size 8, Grey, 7cm dia	Grey	118ml	1 ea / 36 ea
b. 2110	Size 10, Ivory, 6.5cm dia	Ivory	95ml	1 ea / 36 ea
c. 2116	Size 16, Blue, 6cm dia	Blue	70ml	1 ea / 36 ea
d. 2120	Size 20, Yellow, 5.5cm dia	Yellow	60ml	1 ea / 36 ea
e. 2124	Size 24, Red, 5cm dia	Red	45ml	1 ea / 36 ea
f. 2130	Size 30, Black, 4.5cm	Black	35ml	1 ea / 36 ea





Stainless Steel
Ramekins and
Sauce Cups
featured on
page 92

Invertatop™
Squeeze Bottle
(C16SV), assorted
colour silicone bands
(SB53A) and cap
(53FCAPLGN)

f

h

b

c

PROMOTING PRO-PORTIONALITY

FOR WHATEVER SPOONFUL YOU REQUIRE...

From spoons to ladles, we have the capacities you need to portion your ingredients and servings.

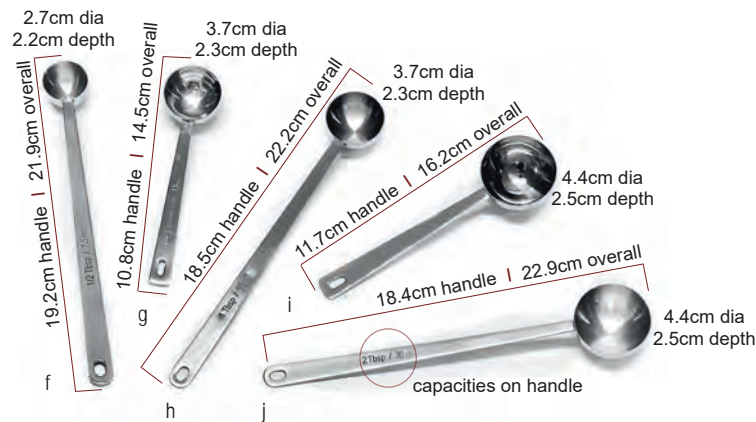
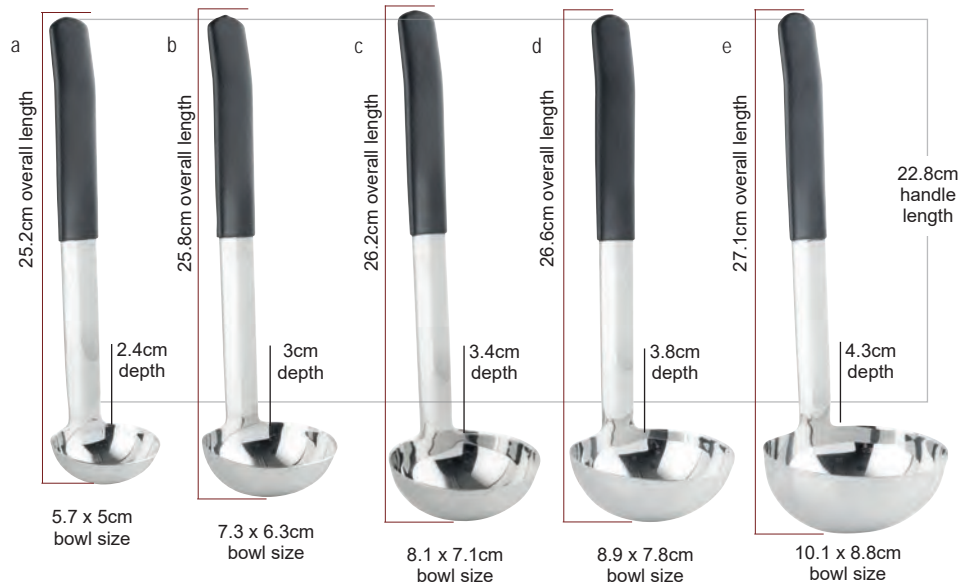

Item #	Description	Min Order
MEASURING LADLES – STAINLESS STEEL		
a.	AM5301BK 30ml / 1oz Measuring Ladle	1 ea / 6 ea
b.	AM5302BK 60ml / 2oz Measuring Ladle	1 ea / 6 ea
c.	AM5303BK 90ml / 3oz Measuring Ladle	1 ea / 6 ea
d.	AM5304BK 120ml / 4oz Measuring Ladle	1 ea / 6 ea
e.	AM5306BK 180ml / 6oz Measuring Ladle	1 ea / 6 ea

Item #	Description	Min Order
MEASURING SPOONS – STAINLESS STEEL		
f.	40400 7.5ml / 0.25oz, Long-Handle Spoon	1 ea / 12 ea
g.	401 15ml / 0.5oz, Short-Handle Spoon	1 ea / 12 ea
h.	40401 15ml / 0.5oz, Long-Handle Spoon	1 ea / 12 ea
i.	402 30ml / 1oz, Short-Handle Spoon	1 ea / 12 ea
j.	40402 30ml / 1oz Long-Handle Spoon	1 ea / 12 ea



LADLE IT ON

These Short-Handled Stainless Steel Ladles with Black Vinyl Coating are versatile for portioning ingredients and provide a comfortable grip for the operator, while keeping food and waste cost low.



GET SPICY WITH IT

Our Long and Short Handled Spoons are ideal for adding any dry or liquid seasonings to your recipe from soy sauce or sesame oil, to shredded parmesan or crushed pepper flakes.

SPOON IN...PORTION OUT.

a

ONE-PIECE SPOONOUTS with colour coated handles help to identify capacities for accurate measuring of recipe ingredients



PIZZA SCREEN

- Promotes even cooking and prevents a soggy base
- Oven safe to 232°C

Item #	Description	Min Order/Case Pack
ALUMINIUM PIZZA SCREEN		
PS13	33cm dia	1 ea / 12 ea



a



b



c

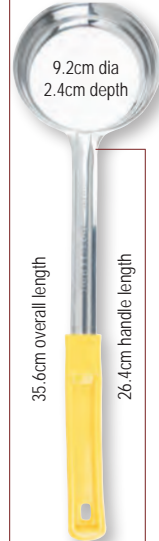

d



e



f

Long-handle Spoonouts are ideal for 110mm to 150mm deep GN pans, especially for liquids (tomato sauce, oil, etc.)

b



ONE-PIECE SPOONOUTS

Cool-to-touch, colour-coded handles indicate capacity ideal for portion control. Available in solid and perforated.

- Stainless Steel and Polypropylene construction
- Capacity markings listed on handle (oz/ml)
- Built in hook for easy hanging and storing
- Safe up to 82°C



Item #	Description	Colour	Capacity	Min Order/ Case Pack
STAINLESS STEEL SOLID SPOONOUT W/ POLYPROPYLENE HANDLE				
a. 6702	33cm Solid, Red Handle		60ml (2oz)	1 ea / 12 ea
b. 6703	33cm Solid, Beige Handle		90ml (3oz)	1 ea / 12 ea
c. 6704	34.5cm Solid, Green Handle		120ml (4oz)	1 ea / 12 ea
d. 6705	34.5cm Solid, Yellow Handle		150ml (5oz)	1 ea / 12 ea
e. 6706	35.5cm Solid, Black Handle		180ml (6oz)	1 ea / 12 ea
f. 6708	35.5cm Solid, Blue Handle		240ml (8oz)	1 ea / 12 ea
STAINLESS STEEL PERFORATED SPOONOUT W/ POLYPROPYLENE HANDLE				
g. 7704	34.5cm Perforated, Green Handle		120ml (4oz)	1 ea / 12 ea

SILICONE & STAINLESS STEEL UTENSILS

- Stainless Steel core with silicone exterior construction provides a durable, flexible and scratch resistant serving utensil option
- Heat safe up to 204°C
- Easy to clean, dishwasher safe



Item #	Description	Min Order/ Case Pack
TOOLS – BLACK SILICONE AND STAINLESS STEEL		
h. 39100	Tongs, 18cm	1 ea / 6 ea
i. 39101	Tongs, 23cm	1 ea / 6 ea
j. 39102	Tongs, 30.5cm	1 ea / 6 ea
k. 10050	28.5cm Serving Ladle, 30ml	1 ea / 6 ea
l. 10051	29.5cm Serving Ladle, 60ml	1 ea / 6 ea
m. 10052	31cm Serving Ladle, 120ml	1 ea / 6 ea
n. 10054	Slotted Spatula, 33cm	1 ea / 6 ea
o. 10055	Solid Spatula, 33cm	1 ea / 6 ea
p. 10053	Fish Turner, 35cm	1 ea / 6 ea



HIGH HEAT UTENSILS

Upgrade your kitchen tools with these NSF certified high heat tools. Never leave a scratch or mark with these non-abrasive silicone tools.

- Heat resistant up to 204°C
- One-piece construction, odour and stain resistant
- Conveniently packaged for cash & carry



Item #	Description	Min Order/ Case Pack
HIGH HEAT TOOLS – SILICONE OVER NYLON, GREY		

a.	11834 ▶ Wide Spatula Spurtle, 7.5 x 2 x 32cm	1 ea / 6 ea
b.	11835 ▶ Narrow Spatula Spurtle, 5 x 2 x 33cm	1 ea / 6 ea
c.	11836 ▶ Wide Slotted Spatula Spurtle, 7.5 x 2 x 26.5cm	1 ea / 6 ea
d.	11837 ▶ Angled Spatula Spurtle, 5.5 x 2 x 26.5cm	1 ea / 6 ea
e.	11838 ▶ Slotted Spurtle, 5 x 2 x 26.5cm	1 ea / 6 ea
f.	11839 ▶ Solid Spurtle, 5 x 1.5 x 22cm	1 ea / 6 ea
g.	11840 ▶ Narrow Spatula Spurtle, 2.5 x 1.5 x 22cm	1 ea / 6 ea
h.	11841 ▶ Small Basting Brush, 3.5 x 1.5 x 21cm	1 ea / 6 ea
i.	11842 ▶ Large Basting Brush, 4.5 x 1.5 x 27.5cm	1 ea / 6 ea
j.	H3900GY 150ml Ladle, 8.5 x 6.5 x 27.5cm	1 ea / 6 ea
k.	H3902GY Spoon, 8.5 x 3 x 29cm	1 ea / 6 ea
l.	H3903GY Perforated Spoon, 10 x 2.5 x 34.5cm	1 ea / 6 ea
m.	H3905GY Slotted Turner, 8 x 3.5 x 30.5cm	1 ea / 6 ea
n.	H3909GY Spatula, 5.5 x 1.5 x 26cm	1 ea / 6 ea
o.	H3910GY Spatula Spoon, 6 x 1.5 x 26cm	1 ea / 6 ea



FOOD TURNERS AND UTENSILS



Essential tools for cooking and prepping, on and off the grill! A range of items available with white or black plastic handles or wood riveted handles to suit your needs on the line.

Item #	Description	Min Order/ Case Pack
STAINLESS STEEL & POLYPROPYLENE BLACK ERGONOMIC HANDLE		
a.	242BKEU Pie Server, 15cm Blade	1 ea / 12 ea
b.	251BKEU Turner, 12.5cm Blade	1 ea / 12 ea
c.	253BKEU Scraper, 7.5cm Blade	1 ea / 12 ea
d.	461BKEU Wide Turner, 11.5 x 16cm Blade	1 ea / 12 ea
e.	4100BKEU Solid Turner, 18cm Rounded Blade	1 ea / 12 ea
f.	4104BKEU Sandwich Spreader, 11cm Blade	1 ea / 12 ea
STAINLESS STEEL & WHITE PLASTIC HANDLE		
g.	242W Pie Server, Plastic Handle, 28cm	1 ea / 12 ea
h.	251W Turner, 29cm	1 ea / 12 ea
i.	253W Scraper, Plastic Handle, 24cm	1 ea / 12 ea
j.	4103W Dough Scraper, 15 x 7.5cm Blade	1 ea / 12 ea
k.	4106W Pizza Wheel, 10cm dia Blade	1 ea / 12 ea
STAINLESS STEEL & BLACK PLASTIC HANDLE		
l.	AM3331BK Pie Server, Plastic Handle, 24.5cm	1 ea / 6 ea
m.	10935 Dough Scraper, 15 x 7.5cm Blade	1 ea / 12 ea
n.	10936 Pizza Wheel, 10cm dia Blade	1 ea / 12 ea
o.	10942 28cm Fish Turner, 15cm Blade	1 ea / 12 ea
STAINLESS STEEL & WOOD HANDLE		
p.	242 Pie Server, Plastic Handle, 28cm	12 ea
q.	254 21.5cm Scraper, 10cm Blade	12 ea
r.	2003 28cm Fish Turner, 15cm Blade	1 ea / 12 ea
s.	4100S 37cm Solid Turner, 20cm Rounded Blade	12 ea



Ergonomic handle for both left and right-handed users



CUTTING BOARDS



Cutting board rack options on page 138



HACCP chart & stickers included in kits



a

Colour-coded for HACCP guidelines

Heat, chemical and warp resistant

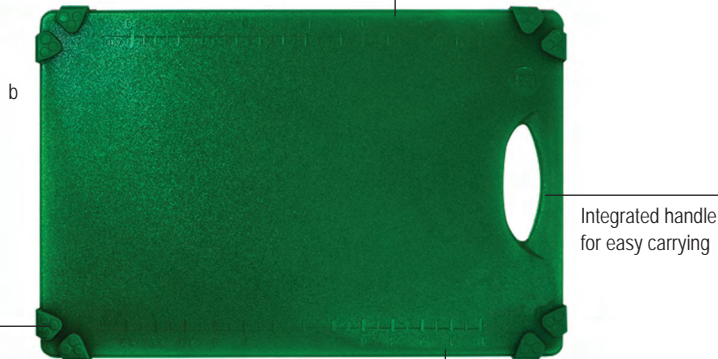

b

Integrated handle for easy carrying

Integrated grips prevent slippage

Integrated measurements help portion foods (cm / inches)

GRIPPY CUTTING BOARDS

- Colour-coded to reduce the risk of cross contamination and promote Hazard Analysis and Critical Control Points (HACCP) guidelines
- Integrated measurements assist with portion control and corner grips help to prevent slippage
- Sanitary and easy to clean with an integrated handle for convenience



Item #	Description	Min Order/ Case Pack
GRIPPY CUTTING BOARDS – POLYPROPYLENE WITH TPE GRIPS		
45.5 x 30.5 x 1.5cm		
CBG1218AWH	White	1 ea / 6 ea
CBG1218AGN	Green	1 ea / 6 ea
CBG1218ARD	Red	1 ea / 6 ea
CBG1218ABR	Brown	1 ea / 6 ea
CBG1218AYL	Yellow	1 ea / 6 ea
CBG1218ABL	Blue	1 ea / 6 ea
a. CBG1218APR	Purple	1 ea / 6 ea
51 x 38 x 1.5cm		
CBG1520ABR	Brown	1 ea / 6 ea
b. CBG1520AGN	Green	1 ea / 6 ea
CBG1520APK4	Pack of 4, Includes: (1 ea of White, Green, Yellow, Red)	1 ea / 6 ea
61 x 45.5 x 1.5cm		
CBG1824AGN	Green	1 ea / 6 ea
CBG1824ABR	Brown	1 ea / 6 ea

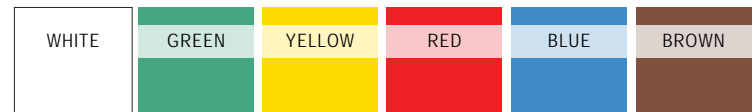

CUTTING BOARDS

- Colour-coded to reduce the risk of cross contamination and promote Hazard Analysis and Critical Control Points (HACCP) guidelines



Item #	Description	Min Order/ Case Pack
CUTTING BOARDS – POLYETHYLENE		
45.5 x 30.5 x 1.5cm		
CB1218BLA	Blue	1 ea / 6 ea
CB1218BRA	Brown	1 ea / 6 ea
a. CB1218GNA	Green	1 ea / 6 ea
CB1218RA	Red	1 ea / 6 ea
CB1218WA	White	1 ea / 6 ea
CB1218YA	Yellow	1 ea / 6 ea
61 x 45.5 x 1.5cm		
CB1824BLA	Blue	1 ea / 6 ea
CB1824BRA	Brown	1 ea / 6 ea
CB1824GNA	Green	1 ea / 6 ea
CB1824RA	Red	1 ea / 6 ea
CB1824WA	White	1 ea / 6 ea
CB1824YA	Yellow	1 ea / 6 ea
FLEXIBLE CUTTING BOARDS – POLYPROPYLENE		
45.5 x 30.5cm (1.4mm THICKNESS)		
b. FCB1218A	Assorted Pack Includes: Blue, Yellow, Green, White, Brown & Red	1 ea / 6 ea



a

Risk of cross contamination is reduced with colour-coding



b

FLEXIBLE CUTTING BOARDS

- Assorted packs include (1) each of blue, green, brown, red, white and yellow



Flexible Cutting Boards are lightweight, useful for outside catering events

CUTLERY TOOLS

CUTTING BOARD RACKS



a

*Brushes and boards not included

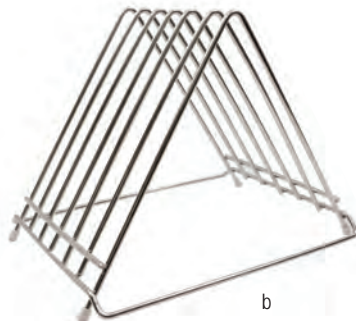

b

KNIFE RACK

- Rack designed to hold 12 knives, 1 cleaver, and 1 sharpener
- 37.5 cm slot depth
- Can be mounted to wall or counter
- Perfect for keeping counter tops clear

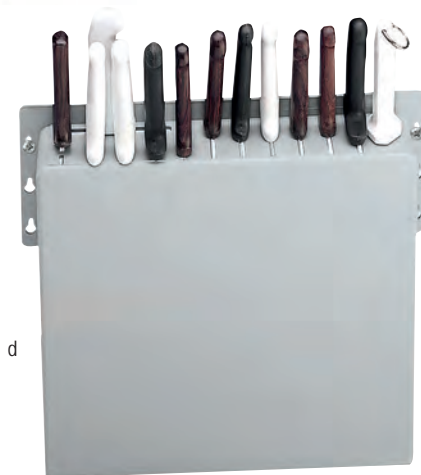

d

*Cutlery not included



e



PERFECTGRIP® KNIFE SHARPENER

- Keep knives sharp with a variety of sharpening tools
- Compact designs, easy to store
- Cash and Carry packaging



c



Item #	Description	Min Order/ Case Pack
CUTTING BOARD RACKS		
a.	CBR6BK Hanging Rack, Black Vinyl Coated Stainless Steel (Holds up to 6 Cutting Boards and Brushes*), 31 x 24 x 25.5cm	1 ea / 10 ea
b.	WSC12 Holding Rack, Stainless Steel, White Feet (Holds 6 Cutting Boards), 26.5 x 34.5 x 26.5cm	1 ea / 6 ea
PERFECTGRIP™ KNIFE SHARPENER - CARBIDE		
c.	*10994 ▶ PerfectGrip™ Handheld Sharpener	1 ea / 12 ea
KNIFE RACK – HIGH IMPACT POLYSTYRENE		
d.	PKR-1 Knife Rack (Holds 12 Knives, 1 Cleaver, 1 Steel, Sharpener), 38 x 40.5 x 7.5cm	1 ea
BLACK MAGNETIC KNIFE HOLDERS – PLASTIC		
	*2913P 34.5cm	1 ea / 36 ea
e.	*2918P 46.5cm	1 ea / 30 ea
	*2924P 62cm	1 ea / 24 ea



SKEWERS

STAINLESS STEEL OR BAMBOO

- Perfect for presenting meat or vegetable kebab-style dishes
- Stainless steel option has an oval wire shape to prevent food from spinning
- Bamboo is single-use



GRATERS



Non-slip grips for safe and easy use back of house



CRINKLE CUT MEZZALUNA



- Speed up prep time
- Single-handed ergonomic design allows for a fast and safe rock-and-slice motion
- Blades will cut through firm fruits and vegetables



Item #	Description	Min Order/ Case Pack
SKEWERS – STAINLESS STEEL		
a. 306	16cm, Oval	60 ea
308	20.5cm, Oval	60 ea
312	30.5cm, Oval	60 ea
314	35.5cm, Oval	60 ea
SKEWERS – BAMBOO (PACK OF 100)		
906	15cm	10 pk
b. 908	20cm	10 pk
910	25cm	10 pk
GRATERS – STAINLESS STEEL, NON-SLIP GRIPS		
c. *SG203BH	Tapered 4-Sided Box Grater, Small, 8.5 x 6 x 15cm	6 ea
d. *SG204BH	6-Sided Grater, 14.5 x 12 x 24cm	6 ea
e. *SG205BH	Tapered 4-Sided Box Grater, Large, 11 x 8.5 x 24.5cm	6 ea
GRATERS – STAINLESS STEEL		
f. SG200	Tapered Grater, 10.5 x 8 x 23.5cm	1 ea / 12 ea
MEZZALUNA – STAINLESS STEEL BLADE, POLYPROPYLENE HANDLE		
g. *H6610	Crinkle Cutter, Single Blade, 19 x 2 x 12.5cm	6 ea



a

BURRITO / TACO FRY BASKETS

- Choice of styles for easy cooking of taco shells, taco cups, tostadas, chimichangas and burritos
- Comfort grip vinyl handle keeps cool when in use



b

c

FRENCH FRY RAIL



e

TACO BOWL FRY BASKET



d

TACO / TOSTODA FRY BASKETS

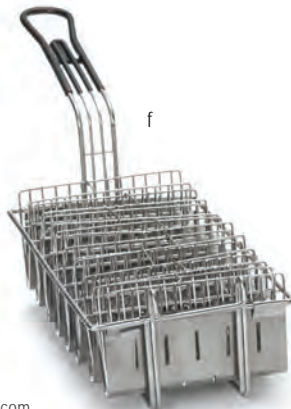

f



g

Item #	Description	Min Order/ Case Pack
BURRITO / TACO FRY BASKETS - NICKEL PLATED METAL WITH RED VINYL HANDLE†		
a.	TB1164 Burrito Fry Basket, 56 x 18 x 26.5cm	1 ea / 6 ea
b.	TB60 Holds Six 15cm Taco Shells, 31 x 16.5 x 7cm, with 23cm Handle	1 ea / 8 ea
c.	TB24039 20cm Double Taco Cups Fry Basket, 34 x 16 x 8cm, with 14cm Handle	1 ea / 12 ea
TACO BOWL FRY BASKETS – CHROME PLATED METAL†		
d.	44080 Deep Basket, 21cm dia x 12cm, with 33cm Handle	1 ea / 4 ea
PREP TRAYS / RAILS – CHROME PLATED METAL †		
e.	4040 Taco / French Fry Rail Holds Twelve 15 cm Taco Shells	1 ea / 2 ea
TACO / TOSTADA FRY BASKET – CHROME PLATED STEEL, BLACK VINYL HANDLES †		
f.	40 Holds Eight 15 cm Taco Shells, 31 x 16.5 x 12cm, with 23cm Handle	1 ea / 8 ea
g.	41 Holds Seventeen 15 cm Tostada Shells, 24 x 16 x 13.5cm, with 20cm Handle	1 ea / 8 ea

† Hand Wash Only



FRY BASKETS

- Colour-coded handles for easy identification
- Comfort grip vinyl handle keeps cool when in use
- Choose from a variety of sizes

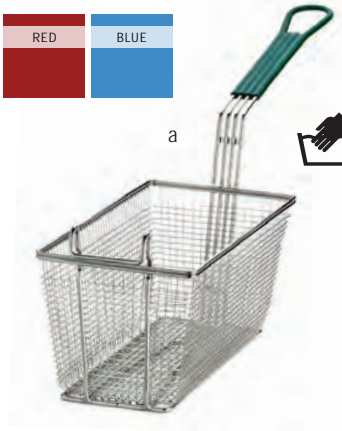

Vinyl Handle Coatings



Item #	Description	Min Order/ Case Pack
FRYER BASKETS – NICKEL PLATED MESH, RECTANGULAR BASKETS †		
a. 42	34 x 16.5 x 15cm, with 29cm Green Handle	1 ea / 12 ea
43	31 x 16.5 x 13.5cm, with 29cm Orange Handle	1 ea / 12 ea
426	28 x 14 x 10.5cm, with 27cm Black Handle	1 ea / 12 ea
427	33 x 16.5 x 14cm, with 28cm Red Handle	1 ea / 12 ea
428	34 x 14.5 x 14.5cm, with 29cm Blue Handle	1 ea / 12 ea
FRYER BASKETS – STAINLESS STEEL MESH, RECTANGULAR BASKETS †		
430	34 x 14.5 x 14.5cm, with 29cm Green Handle	1 ea / 12 ea
431	34 x 14.5 x 14.5cm, with 29cm Red Handle	1 ea / 12 ea
ROUND PASTA BASKETS – 18-8 STAINLESS STEEL, BLUE COOL TOUCH VINYL HANDLE		
984	11.5cm dia x 18cm, with 13.5cm Handle	2 ea
b. 985	13.5cm dia x 18cm, with 13.5cm Handle	2 ea
c. 986	16.5cm dia x 18cm, with 15cm Handle	2 ea
FRENCH FRY SCOOPS – 18-8 STAINLESS STEEL, BAKELITE® HANDLES, HEAT SAFE TO 232°C †		
d. FFD8	Dual Handle 	1 ea / 12 ea
e. FFR8	Right Handle 	1 ea / 12 ea
PLASTIC, HEAT SAFE TO 100°C		
f. PD8	Dual Handle	1 ea / 6 ea
g. PR8	Right Handle	1 ea / 6 ea
PREP TRAYS/RAILS – CHROME PLATED METAL AND 18-8 STAINLESS STEEL		
h. 937	Prep Tray, Holds 7 items, 46.5 x 10 x 5.5cm	1 ea / 24 ea
i. BBQ48*	Prep Tray, Holds 4 Items, 28.5 x 15 x 5cm	6 ea

† Hand wash only

PASTA BASKETS

- Colour-coded handles for easy identification
- Comfort grip vinyl handle keeps cool when in use
- Choose from a variety of sizes



FRENCH FRY SCOOPS

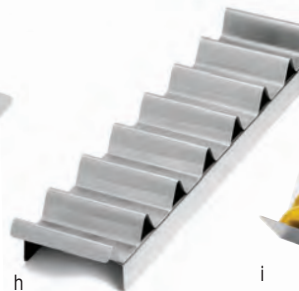

PREP TRAYS / RAILS



**MASH,
SMASH,
SKIM**
AND GIVE IT
A GOOD **FRY.**

MASHERS



**SKIMMERS &
STRAINERS**



Item #	Description	Min Order/ Case Pack
POTATO MASHERS – ASSORTED - STAINLESS STEEL		
a. 7412	11.5cm Diamond Face, 34.5cm Length	1 ea / 12 ea
7418	10cm Square Face, 46cm Length	1 ea / 5 ea
b. 7424	13.5cm Square Face, 61cm Length	1 ea / 5 ea
7432	13.5cm Square Face, 81cm Length	1 ea / 5 ea
CHROME PLATED STEEL WITH BLACK VINYL HANDLE		
c. 7319	11.5cm dia Round Face, 48cm Length	1 ea / 4 ea
SKIMMERS – NICKEL PLATED STEEL		
d. 2409	Round, Spiral Wire, 23cm dia with 31cm Handle	1 ea / 12 ea
e. 2675	Rectangular, Fine Mesh Skimmer, 13 x 15cm with 30.5cm Handle	1 ea / 12 ea
f. 2677	Square, Fine Mesh Skimmer, 17 x 17cm with 34cm Handle	1 ea / 12 ea
g. 3306	Round, Square Mesh Skimmer, 15cm dia with 34.5cm Handle	1 ea / 12 ea
DOUBLE MESH STRAINERS – TIN PLATED, WOOD HANDLES †		
84	20cm dia, Fine Mesh	1 ea / 12 ea
87	26cm dia, Fine Mesh	1 ea / 12 ea
h. 96	16cm dia, Medium Mesh	1 ea / 12 ea
98	20.5cm dia, Medium Mesh	1 ea / 12 ea
99	26cm dia, Medium Mesh	1 ea / 12 ea
SINGLE MESH STRAINERS – TIN PLATED, WOOD HANDLES †		
i. 94	20cm dia, Fine Mesh	1 ea / 12 ea
BOUILLON STRAINER – 18-STAINLESS STEEL		
j. 348	1.9 L, 21.5cm dia, Fine Mesh	1 ea / 6 ea
REINFORCED STRAINERS – TIN PLATED, DOUBLE MEDIUM MESH, WOOD HANDLES †		
1022	26cm dia, Flat Handle	1 ea / 6 ea
k. 1023	29cm dia, Round Handle	1 ea / 6 ea
1024	35cm dia, Round Handle	1 ea / 6 ea

† Hand wash only

4 EGG RINGS



Item #	Description	Min Order/ Case Pack
4 EGG RING – NICKEL PLATED FRAME, NON-STICK RING COATING†		
a. 1240	4 Egg Ring, 10cm dia	1 ea / 2 ea



MEAT TENDERISER



- Cast aluminium option features coarse teeth on one side and a smooth surface on the other
- Wooden handle option features coarse teeth on one side and fine teeth on the other

Item #	Description	Min Order/ Case Pack
MEAT TENDERISERS—CAST ALUMINIUM		
b. 3005	Double-Sided, Flatten or Tenderize	1 ea / 36 ea
c. 3016	Wood Handle, 4-Sided Flatten or Tenderize	1 ea / 12 ea
STEAK WEIGHTS— CAST ALUMINIUM OR CAST IRON, WOOD HANDLES†		
d. 3004	Cast Aluminium, 21 x 10.5 x 4.5cm	1 ea / 12 ea
e. 3033	Cast Iron, 21.5 x 10.5 x 7cm	1 ea / 12 ea
f. BBQ3015	Cast Iron, Round, 17.5cm dia x 8.5cm	4 ea

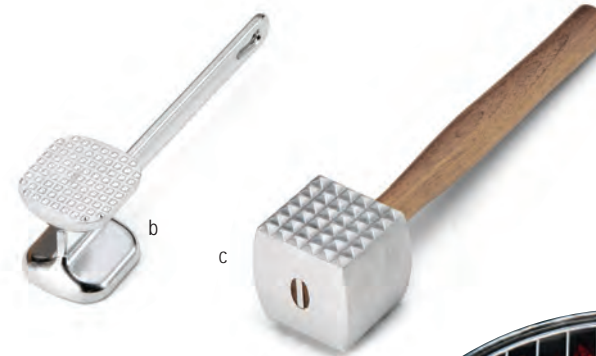

STEAK WEIGHTS

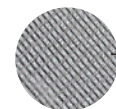

Textured underside



KEEPING
**FOODS
SAFELY
UNDER
WRAPS**



KENKUT® 3 FILM OR FOIL DISPENSER

- Easy way to dispense film and foil – holds 30.5 to 40.5cm roll width, up to 15cm diameter (915m roll)
- Features a slide cutter and safety blade storage
- Hygienic design, complies to HACCP and food code standards
- Stay-open lid for easy loading, reinforced durable hinge system, wall-mounting option and non-slip feet



Item #	Description	Min Order/ Case Pack
KENKUT® DISPENSER – ABS PLASTIC		
a. KK3	Film / Foil Dispenser, 56 x 19.5 x 16.5cm	1 ea
REPLACEMENT PARTS & ACCESSORIES		
b. KK3SRB	Film Slide Cutter Blade for KK3	1 ea / 44 ea
c. RB2	Metal Blade, 45.5cm	1 ea / 1000 ea
d. KK3CLP	Replacement Retaining Clips, For KK3 Dowel Rod	1 ea / 1000 ea

Product support or video training visit: www.kenkut.com

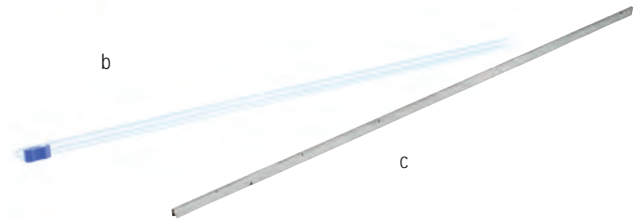

Restraining clip



TIME TO CLEAN UP

GRIDDLE STONE & ACCESSORIES

- Our Griddle Stone Cleaning Blocks grind down during use to make it easy to scour away encrusted dirt and grease, and get into small grooves
- Unlike traditional pumice our Griddle Stone self cleans as it wears down, limiting fatty deposits on the block after each use
- Chemical free, non-toxic and odourless, making it the perfect choice for cleaning your grill
- For best results, scrape surface clean with our Heavy-Duty Grill Scraper (see below) to remove excess residue before use



3119 Griddle Stone & 177 Holder fit together for easy handling

GRILL SCRAPER

- Cut cleanup time in half with our high-quality grill scraper
- Designed for use on flat top grills; scrape off and remove burnt residue, then wipe the grill clean with the attached squeegee
- High heat up to 230°C



Item #	Description	Min Order/ Case Pack
GRIDDLE STONE		
a. 3119	Griddle Stone Cleaning Block (Case of 12)	1 cs
b. 177	Griddle Stone Cleaning Block Holder, Aluminium	1 ea / 6 ea
GRILL SCRAPER – ALUMINIUM W/ BLUE STEEL BLADE †		
c. GS181	Grill Scraper with Squeegee, 35.5cm	1 ea / 8 ea
	GS181WS Heavy Duty Grill Scraper, 35.5cm	1 ea / 10 ea
REPLACEMENT PARTS		
d. GS181RB	Replacement Blade, For GS181	1 ea / 25 ea
	GS181RB-6 Replacement Blades, For GS181 (pack of 6)	1 pk
e. GS181RP	Replacement Parts, For GS181, Includes (1) U-Bolt, (2) Wing Nuts, (2) Bolts	1 ea / 50 ea
f. GS181SQ	Replacement Squeegee, For GS181	1 ea / 12 ea

† Hand wash only

**ORDER
UP...**



a

ORDER HOLDER

- Glass marble design for easy sliding
- Essential addition to all busy service areas
- Wide range of sizes available
- All racks are 2.22cm deep



a

Item #	Description	Min Order/ Case Pack
ORDER HOLDERS – ALUMINIUM†		
5512	30.5cm	2 ea
a. 5518	45.5cm	2 ea
5524	61cm	2 ea
5530	76cm	2 ea
5536	91.5cm	2 ea
5548	122cm	2 ea
5560	152.5cm	2 ea

FUNNELS – WHITE PLASTIC

b. 5	Funnel Set Includes: 5, 7.5, 10, 12.5, 15cm dia	1 set / 12 sets
------	--	-----------------

† Hand wash only

PLASTIC FUNNELS



b





FLATWARE CYLINDERS AND TIERED HOLDERS

- Storage holders for your cutlery and kitchen tools
- Holders not included, sold separately
- All cylinders are available as replacement parts



CUTLERY BINS



Item #	Description	Min Order/ Case Pack
FLATWARE CYLINDERS & TIERED HOLDERS – STAINLESS STEEL, NYLON OR POLYPROPYLENE		
a. 7042	Stainless Steel, 4 Holes, 31 x 26 x 21.5cm Inserts not included	1 ea
b. 7062	Stainless Steel, 6 Holes, 38 x 30 x 21cm Inserts not included	1 ea
c. 1010401	Cylinder, Black, Polypropylene, 11.5cm dia x 14cm	1 ea / 12 ea
d. 34	Cylinder, Stainless Steel, 11.5cm dia x 13cm	1 ea / 12 ea
CUTLERY BINS		
HIGH DENSITY POLYETHYLENE Safe workload up to 11.3kg		
e. 1524G	Grey, 55 x 30 x 9.5cm	12 ea
f. 1524B	Black, 55 x 30 x 9.5cm	12 ea

NSF® OPTION™ DISPENSER

- Prep, store and serve your salad dressings, juices or condiments
- Easy to read labelled ergonomic handles and clear bottles make it simple to identify contents
- Holding tray keeps bottles organised in a cold well. Holder is same size as a full-sized food pan
- Slider prevents drips and keeps countertops clean

1.4 L BPA-free

Set includes (6) dispensers with black plastic tops, (1) tray, (10) different salad dressing tags: Blue Cheese, Fat Free Ranch, Fat Free Italian, French, House, Italian, Ranch, Russian, Thousand Island and Vinaigrette



Item #	Description	Capacity	Min Order/ Case Pack
NSF® OPTIONS DISPENSER – BPA-FREE BOTTLES			
a.	N481 Dispenser Set, White Plastic Tray	(6) 1.4 L	1 set
b.	N481BK Dispenser Set, Black Plastic Tray	(6) 1.4 L	1 set

Item #	Description	Capacity	Min Order/ Case Pack
ECONOMY PUMP – POLYPROPYLENE			
c.	662 1oz Economy Pump, 11.5 x 5 x 41.5cm	30ml	1 ea / 12 ea
LDPE BOTTLES			
d.	32C 32oz Bottle	950ml	12 ea
HDPE JUGS			
e.	1032J 32 oz Jug	950ml	12 ea
STORAGE CAPS			
f.	1017BK Black Cap		1 ea / 400 ea
	1017BR Brown Cap		1 ea / 400 ea
	1017GN Green Cap		1 ea / 400 ea
	1017R Red Cap		1 ea / 400 ea
	1017W White Cap		1 ea / 400 ea
	1017X Orange Cap		1 ea / 400 ea



PLASTIC BOTTLES AND STORAGE CAPS

1032J:
950ml (32 oz)
HDPE Jug
(pump not included)

32C:
950ml (32 oz)
LDPE Bottle
(pump not included)



TABLECRAFT RECOMMENDED CARE & USE FOR YOUR PRODUCTS

Acrylic

When cleaning your acrylic pieces, do not use abrasive cloths or paper towels. Always be sure to use a microfiber cloth to prevent scratching. To sanitize, use warm water mixed with sanitizing dish soap, Hydrogen Peroxide (3%-5% Concentration), or a bleach-water solution (2% Concentration of Bleach). To prevent damage to the surface of your acrylic shield, avoid using ammonia or alcohol based cleaners.. Do not put in the dishwasher. Not microwave or oven safe.

Melamine

Dishwasher safe. Due to the size of some pieces, hand washing is best. We recommend to use a soft cloth and mild detergent, then towel dry. Not microwave or oven safe. Safe for temperatures up to 100°C.

Enamelware

Vitreous Porcelain Enamel Coated Steel Enamelware is a time-honored traditional cooking and serving vessel that has been used for centuries in many ways. A good quality enamelware product can last for years under the right conditions and cared for correctly. Just like any other porcelain piece in the market, porcelain enamel coated steel is not chip resistant and can become worn over the years. The steel substrate of the products is incredibly strong; however the porcelain coating is susceptible to chipping if handled roughly or repeatedly dropped on a hard surface.

To extend the life of your enamelware products, we recommend that you wash before use, do not use abrasive cleaning or scouring pads, do not place empty enamelware on heating element or allow to boil dry on induction unit, gas or electric hobs. Also, before use, coat with a light coating of cooking oil to protect the enamelware from staining. After use, to remove baked on food or stains, soak in warm soapy water and wash gently with non-abrasive liquid detergent.

Enamelware products are commercial dishwasher safe (high & low temp), induction and freezer safe, and safe for direct flame. Not microwave safe.

Porcelain

All pieces are dishwasher and microwave safe. We recommend to use a soft cloth and mild detergent, then towel dry.

Polyethylene/Plastic Bottles

Dishwasher safe (low temperature). Not microwave safe.

Recycled Green Glass

Dishwasher safe. Due to the nature of recycled glass, it is common to notice bubbles and small lines in the finished product. These characteristics are natural qualities of recycled glass — no two pieces are exactly alike. Not microwave or oven safe.

Stainless Steel

Dishwasher safe. For best results, we recommend to hand wash with a soft cloth and mild detergent, then towel dry immediately to maximise their beauty. Do not wash with harsh or abrasive cleaners. Do not allow product to soak in water for extended periods of time (will prevent rust). Not microwave safe.

Galvanised Steel

Hand wash with a soft cloth and mild detergent, then towel dry.

Do not wash with harsh or abrasive cleaners. Do not allow product to soak in water for extended periods of time (will prevent rust). Not microwave safe.

Black Metal / Chrome Plated Baskets or Racks

Hand wash with a soft cloth and mild detergent, then towel dry. Do not wash with harsh or abrasive cleaners. Do not put in the dishwasher.

Polypropylene Baskets

Dishwasher safe (low temperature). Not microwave or oven safe.

Ridal Collection™ Baskets

Dishwasher safe (low temperature). Microwaveable for limited reheat use. Not oven safe.

Willow

For best results, we recommend to hand wash with a soft cloth and mild detergent, then towel dry.

Do not wash with harsh or abrasive cleaners. Do not put in the dishwasher.

Polyethylene/Plastic Baskets

Dishwasher safe (low temperature), microwave safe (for re-heat only) and heat lamp safe up to 65°C.

Wood Products (Acacia, Ashwood, Bamboo, bread boards, pepper mills, etc.)

Hand wash with a soft cloth and mild detergent, then towel dry.

Do not wash with harsh or abrasive cleaners. Do not put in the dishwasher. Do not let product soak in water for extended periods of time (prevents splitting).

PROFESSIONAL BAKEWARE RECOMMENDED CARE & USE FOR YOUR PRODUCTS

Description	Temperature Range in °C	Dishwasher Safe	Only Use Non Caustic Detergents	Oven & Steam Table Safe	Metal Utensil Safe	Metal Scrubbers Safe	Hot Plate Safe
Tri-Ply	-28° up to 232°	Yes	No	Yes	Yes	Yes	Yes
Stainless	-28° up to 232°	Yes	No	Yes	Yes	Yes	Yes
Coated Cast Aluminium	-28° up to 63°	Yes	Yes	No	No	No	No
Natural Cast Aluminium	-28° up to 232°	Yes	Yes	Yes	Yes	Yes	Yes
Die Cast	-28° up to 232°	Yes	Yes	Yes	Yes	No	Yes

ETL® Listing

CW40164, CW40162, CW40160, CW30159, CW30157, CW30158.

The ETL Listed Mark is proof of product compliance (electrical, gas and other safety standards) to North America safety standards.

NSF® Listing

This catalogue was produced January 2021. Item listing is constantly updated, please see NSF®.org for the latest listing information.

Stainless Steel (Tri-Ply)

Stainless Steel cookware is dishwasher safe. However, we recommend hand-drying the cookware immediately after the rinse cycle or hand-washing and drying to preserve the original finish. Prolonged exposure to high heat settings may cause your cookware to discolour. To recondition your cookware or to remove stubborn spots and stains, use a nonabrasive pad and quality Stainless Steel cleanser such as Bar Keepers Friend®.

Cast Iron

Our line of Cast Iron is pre-seasoned, however it is still important to seal the surface of cast iron through a process called "seasoning". This makes the cookware less likely to stick, protects it from corrosion and rust, and prevents food from taking on metallic flavors. With proper care, a well seasoned pan will only get better with time and last for years.

To re-season, allow cookware to cool before cleaning. Wash the pan thoroughly in hot soapy water, then hand dry immediately. Using a cloth or paper towel, grease the pan thoroughly with a thin coating of vegetable oil or melted vegetable shortening. Be sure to coat the entire surface, including all corners. Heat the oven to 175°C. Place the cookware in the oven for 1 hour. Remove while hot and allow to cool to room temperature. Wipe away any excess oil, being careful not to scrub clean, then store.

To preserve the seasoned finish, cast iron must be cleaned differently from other types of cookware. Cast Iron should never be placed inside a dishwasher or scrubbed with scouring pads or steel wool. Instead, wipe the pan clean with a sponge or dishcloth in hot water, without detergent. Any residue may be removed by boiling a little salt and vinegar in the pan, or by rubbing with a paper towel and coarse salt. Hand dry immediately after washing and brush with a thin coating of vegetable oil before storing. If stacking pans, place a paper towel between them. Pans should be seasoned from time to time when needed.

Cast Iron (cont.)

Cast iron cookware is heavy and care should be taken when lifting; where available, use side handles for extra stability. Always use heat protection gloves as handles will become hot.

Cast Iron is not microwave safe. Safe to -17°C.

Cast Iron Rust? Don't panic, it's not broken. Without protective seasoning, iron can rust. To fix, scour the rust, rinse, dry, and rub with a little vegetable oil. If problem persists, you will need to thoroughly remove all rust and follow our re-seasoning instructions.

Cast Aluminium–Natural Finish

The "Naturals" are made of a food safe cast aluminium without coating and are NSF® approved. These items can endure temperatures from –28 up to 230°C. For best results, we recommend to hand wash with a soft cloth, then towel dry immediately to maximise their beauty. Staining will occur if acidic foods are put into the natural products.

Cold Serving Cast Aluminium–Coated

All Coated Cast Aluminium products are NSF® approved and will endure temperatures from –28 up to 63°C. (DO NOT BAKE in the coated cast aluminium products). If a defect in the coating appears, such as peeling or chipping, the product must be taken out of service immediately and repaired or replaced. The intended purpose of the colour coated products is for cold serving & display only. They are not to be used in the preparation of food. Some environmental uses are, but not limited to, buffet lines, catered environments, and in food display cases. Do not cut directly on the products, as this will cause the coating to scratch. Do not put any of the products in an oven, on a stove top, under a heat lamp or in any other condition where the temperature exceeds 90°C. Washing by hand is recommended, but when using a non-caustic detergent, the coating is dishwasher safe. Do not clean with scouring pads. Only use nylon or sponge pads. Regular dish washing will dull the coating. Do not use metal utensils on the colour coated products.

NOTE: Staining of all colour coated products will occur especially if used with acidic foods. The lighter (white, sky blue, and grey) colours are more likely to show stains than darker colours. Staining of products is not covered under warranty.

Aluminium

Not Dishwasher Safe. Wash by hand using a cloth, warm water, and dish soap. Dishwashing will cause discoloration of your aluminium kitchenware.

TERMS & CONDITIONS

1. Definitions

- 1.1 'Buyer' means the person who buys or agrees to buy the goods from the Seller.
- 1.2 'Conditions' means the terms and conditions of sale set out in this document and any special terms and conditions agreed in writing by the Seller.
- 1.3 'Delivery Date' means the date specified by the Seller when the goods are to be delivered.
- 1.4 'Goods' means the articles which the Buyer agrees to buy from the Seller.
- 1.5 'Price' means the price for the Goods excluding carriage, packaging, insurance and VAT
- 1.6 'Seller' means Tablecraft Limited.

2. Conditions applicable

- 2.1 These Conditions shall apply to all contracts for the sale of Goods by the Seller to the Buyer to the exclusion of all other terms and conditions including any terms or conditions which the buyer may purport to apply under any purchase order confirmation of order or similar document.
- 2.2 All orders for Goods shall be deemed to be an offer by the Buyer to purchase Goods pursuant to these Conditions.
- 2.3 Acceptance of delivery of the Goods shall be deemed conclusive evidence of the Buyers acceptance of these Conditions.
- 2.4 Any variation to these Conditions (including any special terms and conditions agreed between the parties) shall be inapplicable unless agreed in writing by the Seller. No other agent or representative of the Seller has any authority to vary or omit these conditions in whole or in part.

3. The Price and Payment

- 3.1 Unless a specific alternative price is agreed prior to delivery the Price of the Goods shall be the price stipulated in the Sellers published price list current at the date of delivery of the Goods. The Price is exclusive of VAT which shall be due at the rate ruling on the date of VAT invoice.
- 3.2 Payment of the Price and VAT shall be due in full without set off or counter claim on the last working day of the month following the end of the month in which the Goods are delivered or the invoice issued, whichever is the earlier. Time for payment shall be of the essence.
- 3.3 Interest on overdue invoices shall accrue from the date when payment becomes due from day to day until the date of payment at a rate of 1% above Lloyds Bank plc's base rate from time to time in force and shall accrue at such a rate after as well as before any judgement. The Buyer will also reimburse the Seller for all costs and expenses including solicitors costs incurred in the collection of any overdue amount and whether or not legal proceedings are commenced.
- 3.4 IF the Buyer fails to make any payments on the due date then without prejudice to any of the Seller's other rights the Seller may:
 - 3.4.1 suspend or cancel deliveries of any articles due to the Buyer; and/or
 - 3.4.2 appropriate any payment made by the Buyer to such of the Goods (or Goods supplied under any other contract with the Buyer) as the Seller may in its sole description think fit.
- 3.5 Further miscellaneous provisions:
 - 3.5.1 All purchases must be made in pack sizes as in our published price list
 - 3.5.2 Payment terms in respect of export orders shall be agreed in writing prior to delivery

4. The Goods / Warranties and Liability

- 4.1 The Seller warrants that the Goods will at the time of delivery correspond to the description given by the Seller. Except where the Buyer is dealing as a consumer (as defined in the Unfair Contract Terms Act 1977 Section 12) all other warranties, conditions or terms relating to fitness for purpose, merchantability or condition of the Goods and whether implied by statute or common law or otherwise are excluded.
- 4.2 Notwithstanding clause 4.1 all drawings specifications product finishes and colour shades in the Sellers catalogue literature and advertisement are approximate and do not constitute a trade description.
- 4.3 The Seller may from time to time make changes in the specification of the Goods which are required to comply with any applicable safety or statutory requirements or which do not materially affect the quality or fitness for purposes of the Goods.
- 4.4 All terms, conditions and warranties (whether implied or made expressly) whether by the Seller or its servants or agents or otherwise (other than those express warranties set out in the current edition of the Sellers specification) relating to the quality and/or fitness for purpose of the Goods or any of the Goods are excluded.
- 4.5 Subject to clause 4.4 the Seller liability to the Buyer shall not in any event exceed the Price and further the Seller shall not be liable for any indirect or consequential loss suffered by the Buyer

5. Delivery of the Goods

- 5.1 Delivery of the Goods shall be made to the Buyer's address on the Delivery Date. The Buyer shall make all arrangements necessary to take delivery of the Goods whenever they are tendered for delivery.
- 5.2 The Seller shall not be liable for any loss or damage whatever due to failure by the Seller to deliver the Goods (or any of them) promptly or at all.
- 5.3 Notwithstanding that the Seller may have delayed or failed to deliver the Goods (or any of them) promptly the Buyer shall be bound to accept delivery and to pay for the Goods in full provided that delivery shall be tendered at any time within 1 month of the Delivery Date.
- 5.4 The Seller may deliver the Goods by separate instalments. Each separate instalment shall be invoiced and paid for in accordance with the provisions in this contract of sale.
- 5.5 The failure of the Buyer to pay for any one or more of the said instalments of the Goods on the due dates shall entitle the Seller (at the sole option of the Seller):
 - 5.5.1 without notice to suspend further deliveries of the Goods pending payment by the Buyer; and/or

5.5.2 to treat this contract as repudiated by the Buyer.

- 5.6 Unless quoted otherwise UK mainland deliveries are free of charge on all orders over the value of £600 List pricing. Orders under this value will be charged at a set rate at the beginning of each calendar year. All deliveries are on a next day service.
- 5.7 Outside mainland UK deliveries are charged according to the standard rates set at the beginning of the year by the freight companies assigned to the order unless otherwise agreed.
- 5.8 The Goods shall be at the Buyer's risk as from delivery.
- 5.9 Ownership of the goods does not transfer to the buyer until the invoice is paid in full.

6. Acceptance of the Goods

- 6.1 All deliveries must be checked that all boxes are presented and in good condition before signing.
- 6.2 A 'clean' signature prevents any claim against the carriers and may result in any claim being rejected by TableCraft Limited.
- 6.3 The Buyer shall be deemed to have accepted Goods 48 hours after delivery to the Buyer
- 6.4 After acceptance the Buyer shall not be entitled to reject Goods which are not in accordance to the contract.
- 6.5 No claims for shortage or picking errors will be accepted unless received in writing quoting the delivery note number within 48 hours of delivery of the Goods.
- 6.6 Claims in respect of non-delivery shall be made in writing within 7 days of receipt of invoice to which they relate failing which delivery will be deemed and payment will be due in accordance with these conditions.
- 6.7 Damage to any of the Goods must be notified in writing to the Seller within 48 hours of delivery. Any Goods rejected by the Buyer as damaged must be retained in the original packaging and made available for inspection by the Seller or its authorised agent.

7 Return of Goods / Cancellation

- 7.1 Save as agreed by the Seller in writing and in its own absolute discretion no Goods shall be accepted for return.
 - 7.2 In the event of acceptance for return of Standard UK stocked items a handling charge of 25% of the Price shall be applied providing return is made within 30 days. After this date standard UK Stocked items will not be accepted for return. Non-UK Standard stocked catalogue items will be charged at the Price and notwithstanding return of Goods.
 - 7.3 Returned items will only be accepted with the correct authorised returns number for that item. No credit will be given for items returned with no authorised returns or included with another return.
 - 7.4 Goods in an unstable condition or with defaced packaging will not be accepted for return
 - 7.5 All authorised returns must be in their original packaging and in a re-saleable condition and inspected by the Sellers warehouse and authorised only then full a full refund or agreed costs to be credited.
 - 7.6 Risk in the Goods to be returned shall remain with the Buyer until received or collected by the Seller.
 - 7.7 With the consent of the Seller and subject to 7 days notice prior to the delivery Date orders for goods (other than customised goods , specials and non UK Stocked items) may be cancelled or deferred but the Seller reserves the right to charge for any exceptional costs it incurs as a result of such cancellation.
 - 7.8 The Seller may cancel this contract at any time before the Goods are delivered by giving written notice. On giving such notice the Seller shall promptly repay to the Buyer any sums paid in respect of the Price. The Seller shall not be liable for any loss or damage whatever arising from such cancellation.
- ## 8. Remedies of Buyer
- 8.1 Where the Buyer validly rejects any Goods then the Buyer shall have no further rights whatever in respect of the supply to the Buyer of such Goods or the failure by the Seller to supply Goods which conforms to the contract of sale.
 - 8.2 Where the Buyer accepts or has been deemed to have acceptance any Goods then the Seller shall have no liability whatever to the Buyer in respect of those Goods
 - 8.3 The Seller shall not be liable to the Buyer for late delivery or short delivery of the Goods.
- ## 9. Miscellaneous
- 9.1 Any notice required to be served pursuant to this contract of sale shall be in writing and served by first class post or by hand on the Seller at 27 Causeway Road, Earlstrees Industrial Estate, Corby, Northants, NN17 4DU or such other address as the Seller may from time to time notify to the Buyer and on the Buyer at the Buyer's registered office or principal place of business.
 - 9.2 The Seller may licence or sub-contract all or any part of its rights and obligations under this contract without the Buyer's consent.
 - 9.3 Neither party shall be liable for any default due to any act of God, war, strike lockout, industrial action, fire, flood, drought, tempest or other event beyond the reasonable control of either party.
- ## 10. Proper law of contract
- 10.1 This contract is subject to the law of England and Wales.
 - 10.2 The parties submit to the exclusive jurisdiction of the courts of England and Wales and irrevocably agree that proceedings issued out of the said courts may without prejudice to the rules of service of such courts be served on them by delivering such proceedings in an envelope addressed to the party to be served at the address for such party as in Clause 10.1
- ## 11. Statutory Rights
- 11.1 Nothing herein contained shall alter or affect the Buyer's statutory Rights.

©2024 TableCraft Products Company, inc. All rights reserved. No portion of this catalogue may be reproduced without the express written permission of the copyright holder. TableCraft Products Company, Inc. All rights reserved.

Disclaimer

TableCraft is not responsible for printing errors. Product case packs, specifications, terms or conditions of sale are subject to change without notice. All products are subject to standard VAT as set out by the UK government guide lines.

European Office

44(0)1536.400091
44(0)1536.201492 fax
salesuk@TableCraft.com

European Representatives

Germany

Lentz International
49.171.54.46.660
marc@lentz-international.de

Greece

Fornaro Business Agency
30.210.3235435
30.210.3225429 fax
Irene@fornaro.gr

Italy

F.S.G. Italia
39.0522.902.051
39.0522.902.017 fax
info@fsg-italia.it

Portugal

Hotel Restaurant Co
351.918.550.429
jq@hotelrestaurantco.com

CIS

Marina Plyaskina
7495.668.70.69
tablecraft@combocom.ru

Scandinavia

SMAG
47.4174.9926
47.9477.5454 fax
anders@smag.no

International Representatives

Canada

W.D. Colledge Co. Ltd.
905.677.4428 | 877.677.4428
905.677.5357 fax
cjeens@wcdcolledge.com

Mexico, Caribbean, Central America

Johnson Sales Company
954.927.3900
954.927.3909 fax
Johnson@johnsonsalesco.com

New Zealand, Sub-Saharan Africa,

Indian & Pacific Ocean Isles
Jack Warren
+27 76 042 8199
jack@warrenint.com

Southeast Asia & China

CP Solutions (Asia) Company
Limited
852.2621.3001
852.2621.3002 fax
michael@cp-asia.com

U.S. Representatives

Carolina Foodservice Solutions

984.235.7767
info@
carolinafoodservicesolutions.com
North Carolina, South Carolina

Ellsworth

Marketing Associates
678.691.8104
678.691.8105 fax
rellsworth@ellsworthmarkassoc.com
Georgia, East Tennessee,
Alabama, Florida Panhandle

Finn Foodservice

800.451.6755
(813) 925-1607 fax
jay@FinnFS.com
Florida (Except Panhandle)

Forbes Hever & Wallace, Inc.

800.526.1126
orders@your-rep.com
Texas (Except El Paso), Oklahoma

Elevate Foodservice Group

617.546.2360
connect@elevatefsg.com
Massachusetts, New Hampshire,
Rhode Island, Maine, Vermont,
Connecticut

Greenwald Sales & Marketing

614.404.7733
melissa@greenwaldsales.com
Ohio, West Virginia, Indiana,
Kentucky

KC Marketing

412-638-1112
kcmarketing2022@gmail.com
Western Pennsylvania

Lane Marketing Group

410-974-1108
anne@lanegroup.com
Maryland, District of Columbia,
Virginia

Lake Effect Sales & Marketing

(716) 998-5963
davea@lakeeffectfs.com
Upstate New York

Mancini And Associates, Inc.

610.659.1716
manciniandassociates@comcast.net
Eastern Pennsylvania, Delaware,
Southern New Jersey

Mid-West Associates

586.263.1229
mike@midwestassociates.net
Michigan

Mirkovich and Associates

630.792.0080
630.792.9914 fax
Ed@mirkovich.com
Richard@mirkovich.com
Northern Illinois, Northwest
Indiana, Eastern WI

NorthStar Agency

612.751.2886
ben@northstaragency.com
Minnesota, Western Wisconsin,
North & South Dakota

EMC

503.998.4599
michaelh@emchospitality.com
Pacific Northwest, Idaho,
Montana,
Northern & Southern California,
Northern Nevada, Las Vegas,
Hawaii

P3 Reps

201.797.2266
(201) 797-2266 fax
kim@p3reps.com
New York Metro,
Northern New Jersey

The Pinnacle Group

314.770.2044
314.770.2435 fax
heather@tpgreps.com
Missouri, Iowa, Nebraska,
Kansas, Southern Illinois

Curate

303.373.1940
303.371.1557 fax
info@curateteam.com
Utah, Colorado, Wyoming,
Texas (El Paso), Arizona, New
Mexico

Wallin Foodservice Resources

504.733.3344
504.733.0854 fax
brent@wallinfsr.com
Mississippi, Louisiana, Arkansas,
Western Tennessee

WANTING **More?**

EU.TABLECRAFT.COM

Or follow us on social media:



/tablecraftEU



@tablecraftEU



@tablecraftEU



/tablecraft-products-company



TABLECRAFT NUMERIC INDEX

5	155	85	42	406	79	852F	43	1174W	103	3016	151	5488	72
12SV	118	87	150	421	30	906	147	1175W	103	3033	151	5488W	72
16SV	118	94	150	422	30	908	147	1176W	103	3119	154	5512	155
21	111	95	64	426	149	910	147	1177W	103	3263C	120	5518	155
22	111	96	150	427	149	913A	90	1188W	103	3263C3	122	5524	155
23	112	98	150	428	149	913AS	90	1189W	103	3306	150	5530	155
23BK	112	99	150	430	149	916	77	1192W	103	3711	134	5536	155
24	112	100TC	124	431	149	916R	77	1218BK	67	3712BKEU	135	5548	155
24BK	112	100TK	124	461BKEU	143	918	76	1240	151	3712BLEU	135	5560	155
24SV	119	100TM	124	501K	64	918R	76	1370G	78	3712GEU	135	5834	67
30S&P	81	101	70	512	66	937	149	1370T	78	3712REU	135	6618	83
32C	124, 157	102	69	513	79	984	149	1471	103	3712YEU	135	6619	83
32SV	119	103	69	514	79	985	149	1474	103	3715	134	6702	141
34	156	104	69	515	79	986	149	1475	103	3716BKEU	135	6703	141
35BK	62	105	68, 70	518	112	1006AS	90	1500	131	3716BLEU	135	6704	141
35G	62	107	68, 70	519	112	1017BK	157	1510	131	3716GEU	135	6705	141
35R	62	131B	72	522	79	1017BR	157	1514	131	3716REU	135	6706	141
35W	62	132S&P-2	81	526T	64	1017GN	157	1516	131	3716YEU	135	6708	141
40	148	146A	62	557TCH	91	1017R	157	1524B	156	3774BKEU	135	7042	156
41	148	150S&P-2	81	597P	62, 76, 80	1017W	157	1524G	156	3774BLEU	135	7062	156
42	149	154S&P-2	81	598P	62	1017X	157	1602	70	3774GEU	135	7319	150
43	149	155S&P-2	81	599P	76, 77, 80	1022	150	1603	70	3774REU	135	7412	150
53FCAP	118	156S&P-2	81	600	77	1023	150	1604	70	3774YEU	135	7418	150
53FCAPA	118	159	133	600N	77	1024	150	1605	70	4009BK	135	7424	150
53TBL	120	163S&P-2	81	600T	78	1032J	157	1606	70	4012BK	135	7432	150
53TC	120	163T	81	605	66	1071BK	106	1607	70	4016BK	135	7704	141
53TK	120	166A	133	611	80	1071R	106	1802	62	4040	148	8032	61
53TM	120	166C	133	611N	80	1073BK	107	1862	131	4100BKEU	143	8032A	61
53TSVN	118	166D	133	612	66	1073FG	107	1863	131	4100S	143	8032BKBK	61
55S-4	84	166F	133	615	76	1073R	107	1864	131	4103W	143	8064	61
55T	78	172	112	624	66	1074BK	106	1865	131	4104BKEU	143	8064A	61
56B	85	177	154	638	66	1074BK-6	106	1866	131	4106W	143	8128A	61
56C	85	237	51	658	66	1074BL	106	1867	131	4206	133	8381	112
60EU	113	242	143	662	157	1074BR	106	2003	143	4208	133	9085	77
61EU	113	242BKEU	143	667	68	1074FG	106	2009	134	4210	133	9085R	77
61EUA	113	242W	143	685	66	1074G	106	2012	134	4212	133	9085RBK	77
63EU	113	251BKEU	143	693	23	1074R	106	2014	51	4214	133	9803	93
63EUA	113	251W	143	705	131	1074R-6	106	2016	134	4244A	62	9805	93
63FCAP	119, 121	253BKEU	143	707B	72	1074Y	106	2024	51	4701	134	9808	93
63FCAPA	119	253W	143	708	131	1075BK	107	2036	51	4702	134	9812	93
63TC	120, 121	254	143	712	134	1075FG	107	2108	137	4703	134	10006	70
63TC3	121, 122	260	84	713	131	1075R	107	2110	137	4704	134	10007	70
63TK	120	260SL	84	716	134	1076BK	106	2116	137	4706	134	10034	98
63TM	120	295X	62	722	136	1076BR	106	2120	137	4708	134	10035	98
64E	51	300	49	724	136	1076FG	106	2124	137	4712	134	10036	98
65EU	113	306	147	725	136	1076R	106	2130	137	4937	70	10037	98
65EUA	113	308	147	753BK	67	1077BK	107	2132C	123	5063	92	10038	98
66EU	113	312	147	797	39	1077BR	107	2303	51	5064	92	10039	98
66EUA	113	314	147	800-4	84	1077R	107	2409	150	5066	92	10040	98
67EU	113	320A	62	821U	30	1079BK	107	2504	39	5067	92	10041	98
70	43	320C	62	822	131	1079FG	107	2508	39	5068	92	10042	98
70F	43, 46	330	62	823	131	1079R	107	2510	131	5071	92	10043	98
74	134	345	62	824	131	1084BK	106	2512	39	5072	92	10050	33, 141
75	42	348	150	825	131	1084R	106	2514	131	5073	92	10051	33, 141
75F	42	353DP	43	826	131	1086BK	106	2516	131	5122	67	10052	33, 141
75FM	42	357	83	827	131	1086R	106	2675	150	5132	67	10053	33, 141
76	63	363TC	121	828	131	1102	123	2677	150	5142	67	10054	33, 141
77	63	364	49, 66	830	131	1104	123	2712	134	5188	73	10055	33, 141
83P	81	375	63	833	88	1112C	123	2716	134	5198	73	10076	100
83S	81	376	63	839	89	1112K	123	2774	134	5200	67	10077	100
83S&P	81	377	63	840	89	1112KMC	123	2913P	146	5222	67	10078	100
83T	81	396	64	843	89	1112M	123	2918P	146	5232	67	10079	100
83T1	81	398	72	846	88	1155	85	2924P	146	5242	67	10080	100
83TP	81	401	50, 139	848	89	1157	85	3004	151	5288	73	10081	100
84	150	402	50, 139	850	88	1171W	103	3005	151	5398	73	10090	45

TABLECRAFT NUMERIC INDEX

10162BK	122	10553	58	10995	128	11638	34	11868	55	BAMDCP1	38	BKDIA728	85
10173	46	10554	58	10996	128	11639	34	11869	55	BAMDCP2	38	BKP4	91
10217	60	10555	58	10997	128	11640	34	11884	29	BAMF35	36	BKR4	25
10262	46	10556	58	11000	18	11641	34	11885	29	BAMH6	36	BLEU	37
10263	85	10557	58	11207	129	11642	34	11886	29	BAMH45	36	BSC0610	66
10285A	60	10558	58	11208	129	11655	90	11887	29	BAMK7	36	BSC1216	66
10286BR	60	10559	58	11209	129	11656	90	12159	92	BAMK35	36	BSC2024	66
10286GN	60	10560	58	11210	129	11657	98	12160	92	BAMK45	36	BT1914	47
10286R	60	10561	58	11211	129	11658	98	12463C3	122	BAML7	36	BT2013	47
10286W	60	10562	58	11253C-12	120	11659	97	12463C3F	121	BAML35	36	BT2137N	47
10286X	60	10626	46	11253K-12	120	11660	97	12463C-12	120	BAMLP45	36	BTB1610	47
10286Y	60	10709	13, 94	11253M-12	120	11663C3	122	12463CF	121	BAMP5G	37	C12SV	118
10289	88	10710	13, 94	11291	101	11663C3F	121	12463K-12	120	BAMP7	37	C16SV	118
10290	88	10711	94	11292	101	11663C-12	120	12463M-12	120	BAMP35	37	C24SV	119
10291	88	10727	122	11293	101	11663CF	121	13759BK	107	BAMP35A	37	C56W	85
10292	88	10746	13, 95	11294	101	11663K-12	120	15759BK	107	BAMP35G	37	C57S-4	84
10303	88	10764	13, 95	11295	101	11663M-12	120	20002	71	BAMP45	37	C100TA	124
10308	85	10765	17, 111	11296	101	11688	81	20005	90	BAMP45A	37	C100TBK	124
10309	85	10766	17, 111	11297	101	11689	82	31763C	121	BAMP45PR	37	C100TC	124
10360	45	10778	56	11298	101	11692	21	32563C	121	BAMP45VG	37	C170-12	80
10361	46	10779	56	11299	101	11693	21	39100	33, 141	BAMPS6	37	C3263C	120
10399	111	10780	56	11300	101	11694	21	39101	33, 141	BAMPS45	37	C10853C	120
10422	6	10781	56	11301	101	11695	21	39102	33, 141	BAMSP145	36	C10853K	120
10423	6	10784	56	11401	66	11696	21	39105	141	BAMSP245	36	C10853M	120
10424	6	10785	56	11402	66	11697	54	40400	50, 139	BAMSP345	36	C11253C	120
10425	6	10786	56	11403	66	11698	54	40401	50, 136, 139	BAMSP45	36	C11253K	120
10426	6	10787	56	11404	66	11699	54	40402	50, 136, 139	BAMSP645	36	C11253M	120
10427	6	10788	57	11405	66	11758	50	44080	148	BBQ48	149	C11663C	120
10428	6	10789	57	11435	93	11784	22	60125	77	BBQ3015	151	C12463C	120
10429	6	10790	57	11436	93	11785	22	123494	45	BCD1400	68	C12463K	120
10430	6	10791	57	11437	93	11786	22	123495	45	BCD6000	69	C12463M	120
10431	6	10794	57	11440	28	11787	22	123496	45	BCD6000BK	69	CB1218BLA	145
10432	6	10795	57	11441	28	11794	18	123497	45	BDCHBD	46	CB1218BRA	145
10433	6	10796	57	11442	28	11795	17	157510BK	107	BDG1000	45	CB1218GNA	145
10434	6	10797	57	11443	28	11796	17	157510R	107	BDG2000	45	CB1218RA	145
10435	6	10820	104	11447	16	11797	16	240010	92	BDG3000	45	CB1218WA	145
10436	6	10821	104	11448	16	11798	16	821422	30	BDGF	42, 45, 46	CB1218YA	145
10437	6	10822	104	11519	30	11814	55	1010401	156	BDGR1	46	CB1824BLA	145
10438	6	10853C-12	120	11522	102	11815	55	AC885H	93	BDGR2	46	CB1824BRA	145
10439	6	10853K-12	120	11523	102	11816	55	AC885S	93	BDGTUB	46, 47	CB1824GNA	145
10454	11	10853M-12	120	11524	102	11817	55	ACAMBB1507	100	BH2	78	CB1824RA	145
10462	105	10904	58	11525	102	11819	55	ACAMR14	100	BH3	78	CB1824WA	145
10463	105	10924	82	11559	8	11820	55	ACAMR2007	100	BH7	78	CB1824YA	145
10464	105	10925	82	11560	8	11821	55	ACARD16	100	BH855	78	CBG1218ABL	144
10468	59	10973	64, 128	11561	8	11822	55	AM3709BL	135	BIEN CUIT	37	CBG1218ABR	144
10469	59	10974	128	11562	8	11824	55	AM3709G	135	BK155	85	CBG1218AGN	144
10470	59	10975	128	11563	8	11825	55	AM3716BK	135	BK11709	104	CBG1218APR	144
10471	59	10976	128	11564	6	11826	55	AM3716G	135	BK17209	104	CBG1218ARD	144
10472	59	10977	128	11575	39	11827	55	AM3716Y	135	BK17409	104	CBG1218AWH	144
10473	59	10978	128	11576	39	11828	19	AM5301BK	33, 139	BK17410	104	CBG1218AYL	144
10474	59	10979	128	11577	39	11829	19	AM5302BK	33, 139	BK17506	104	CBG1520ABR	144
10475	59	10980	128	11622	17	11830	19	AM5303BK	33, 139	BK17508	104	CBG1520AGN	144
10486	98	10981	128	11623	17	11832	82	AM5304BK	33, 139	BK17510	104	CBG1520APK4	144
10487	98	10982	128	11626	34	11834	32, 142	AM5306BK	33, 139	BK37109	105	CBG1824ABR	144
10488	98	10983	128	11627	34	11835	32, 142	A POINT	37	BK37408	105	CBG1824AGN	144
10520	59	10984	128	11628	34	11836	32, 142	BAD1500	43	BK37409	105	CBR6BK	146
10534	105	10985	128	11629	34	11837	32, 142	BAMDB3	38	BK37515	105	CH2	39
10535	105	10986	128	11630	34	11838	32, 142	BAMDB5	38	BK171172	104	CH5	39
10536	105	10987	128	11631	34	11839	32, 142	BAMDB8	38	BK171182	104	CHX4	39
10537	105	10989	128	11632	34	11840	32, 142	BAMDB45	38	BK171372	104	CR3	25
10545	90	10990	128	11633	34	11841	32, 142	BAMDB65	38	BKC2202	39	CRATE11	14
10546	90	10991	128	11634	34	11842	32, 142	BAMDCB35	36	BKC2206	39	CRATE11BK	14
10547	90	10992	128	11635	34	11846	21, 125	BAMDCN5	38	BKC2208	39	CRATE11W	14
10548	90	10993	128	11636	34	11847	21, 125	BAMDCN6	38	BKC2212	39	CRATE12	14
10552	58	10994	128, 146	11637	34	11867	55	BAMDCN7	38	BKDIA595	85	CRATE12BK	14

TABLECRAFT NUMERIC INDEX

CRATE12W.....	14	FSR3.....	95
CRATE13.....	14	FTR1711.....	91
CRATE13BK.....	14	GHB10.....	71
CRATE13W.....	14	GHB16.....	71
CRATE14.....	14	GHB24.....	71
CRATE14W.....	14	GHC10.....	71
CRATE114.....	14	GHC16.....	71
CRATE114BK.....	14	GHC24.....	71
CRATE116.....	14	GM1212.....	23
CRATE124.....	14	GM1519.....	23
CRATE126.....	14	GM1608.....	23
CRATE134.....	14	GM2113.....	23
CRATE136.....	14	GMT2412.....	23
CRATESB11.....	15	GMT13105.....	23
CRATESB11BK.....	15	GMT21125.....	23
CST363B-1.....	72	GPSS8.....	97
CW2030.....	10	GPSS10.....	97
CW2032.....	10	GPSS89.....	97
CW2034.....	10	GPSS90.....	97
CW2034L.....	10	GPSS96.....	97
CW2042.....	10	GPSS120.....	97
CW2044.....	10	GPSS129.....	97
CW7000.....	10, 89	GPSSCADDY.....	97
CW7000L.....	10, 89	GRSS1.....	92, 97
CW7000LM.....	89	GRSS2.....	92, 97
CW7010.....	10	GRSS3.....	92, 97
CW7012.....	10	GS181.....	154
CW7014.....	10	GS181RB.....	154
CW7020.....	10	GS181RB-6.....	154
CW30100.....	12, 95	GS181RP.....	154
CW30102.....	13, 95	GS181SQ.....	154
CW30104.....	13, 95	GS181WS.....	154
CW30108.....	12, 95	GT2313.....	47
CW30110.....	13, 95	GTSS4.....	97
CW30112.....	13, 95	GTSS28.....	97
CW30114.....	12, 94	GTSS31.....	97
CW30116.....	12, 94	GTSS33.....	97
CW30118.....	12, 94	GTSS44.....	97
CW30122.....	12, 95	GTSS45.....	97
CW30124.....	12, 95	GTSS87.....	97
CW30140.....	13, 95	GTSS375.....	97
CW30142.....	13, 95	GTSS2313.....	47
CW30148.....	13, 95	GTSS2313AT.....	47
CW30150.....	13, 95	GTSS2313CT.....	47
CW30151.....	13, 95	GTSS2313N.....	47
CW30152.....	12, 94, 95	GTSS2313S.....	47
CW40297.....	8	H15S&P.....	80
CW60100.....	4	H77.....	63
CW60101.....	4	H119Y.....	64
CW60103.....	4	H158.....	133
CWA12.....	4	H159.....	133
CWA20.....	4	H211.....	63
CWDC1030.....	11	H320C.....	62
CWDC1040.....	11	H398.....	72
CWDC1050.....	11	H475S&P.....	80
CWDC1070.....	11	H475ST.....	80
DCBK.....	62	H475T.....	80
DCH01.....	39	H501K.....	64
DCH27.....	39	H503K.....	64
DCL.....	62	H633.....	65
FC1649.....	23	H714CH.....	51
FCB1218A.....	145	H820P.....	30
FFD8.....	149	H820P422.....	30
FFR8.....	149	H916N.....	77
FLIGHT1.....	71	H918N.....	76

H931.....	80
H1206.....	63
H1229.....	72
H1230C.....	72
H1246.....	64
H1604.....	70
H2997BH.....	133
H3900GY.....	32, 142
H3902GY.....	32, 142
H3903GY.....	32, 142
H3905GY.....	32, 142
H3909GY.....	32, 142
H3910GY.....	32, 142
H4258.....	63
H5633.....	65
H6610.....	147
H9085N.....	77
H9085NBK.....	77
H110204.....	123
HB1.....	32
HBH860.....	78
HBT1914.....	47
HDS492.....	79
GRSS1.....	92, 97
GRSS2.....	92, 97
GRSS3.....	92, 97
HVN142.....	79
JC1032A.....	60
JC1064A.....	60
JC1128A.....	60
JJ1202.....	63
JJ1205.....	63
JJ1206.....	63
KK3.....	153
KK3CLP.....	153
KK3SRB.....	153
M2474.....	103
M2475.....	103
M2485.....	103
M2489.....	103
M2493.....	103
MEDIUM.....	37
MEDRARE.....	37
MEDWELL.....	37
MG1120BK.....	5
MG1120W.....	5
MG1165BK.....	5
MG1165W.....	5
MG1265BK.....	5
MG1265W.....	5
MG1365BK.....	5
MG1365W.....	5
MG1465BK.....	5
MG1465W.....	5
MG2420BK.....	5
MG2420W.....	5
MG11100BK.....	5
MG11100R.....	5
MG11100W.....	5
MG12100BK.....	5
MG12100R.....	5
MG12100W.....	5
MG13100BK.....	5
MG13100R.....	5
MG13100W.....	5
MW40.....	132

N20C.....	122
N32A.....	61
N32LPA.....	61
N175.....	42
N175F.....	42
N481.....	157
N481BK.....	157
P555.....	84
P57S.....	84
P260.....	84
P260SL.....	84
P800.....	84
P800BK.....	84
PB5119.....	72
PC1.....	31
PCD1.....	28, 30
PCD2.....	30
PD8.....	149
PKR-1.....	146
PM1918.....	82
PP321.....	49
PR8.....	149
PS13.....	140
RACA300.....	24
RARE.....	37
RB2.....	153
RBAM300.....	24
RBK300.....	24
RCBCRATE1.....	15
RCBCRATE1SM.....	15
RCBCRATE2.....	15
RFTT3BAML.....	27
RFTT3BAMM.....	27
RFTT3BAMS.....	27
RFTT3BKL.....	27
RFTT3BKM.....	27
RFTT3BKS.....	27
RGC34.....	48
RIB76.....	72
RP68.....	49
RR3.....	25
RS3.....	24
RS1432.....	73
RS2132.....	73
RSB33.....	48, 77
S209.....	63
SAIGNANT.....	37
SB53A.....	124
SB63A.....	124
SF10.....	132
SF12.....	132
SF14.....	132
SF16.....	132
SF18.....	132
SF20.....	132
SF24.....	132
SG200.....	147
SG203BH.....	147
SG204BH.....	147
SG205BH.....	147
SP10.....	132
SP12.....	132
SP14.....	132
SP16.....	132
SQH6.....	125

SQH8.....	125
ST363B-1.....	72
T4.....	125
T6.....	125
T8.....	125
TB60.....	148
TB1164.....	148
TB24039.....	148
TRS12.....	91
TRS23.....	91
TRS34.....	91
TRSP12.....	91
TRSP23.....	91
TRSP34.....	91
TRW12.....	91
TRW23.....	91
TRW34.....	91
V119.....	64
V119GN.....	64
W12.....	131
W14.....	131
W16.....	131
W18.....	131
WBAM3.....	24
WBK3.....	24
WELLDONE.....	37
WF200BK.....	71
WP5BKEU.....	72
WPA5SS.....	72
WSC12.....	146



Scan to access our ftp site
links.tablecraft.com_ftpeu
 for additional marketing
 materials and product
 images available 24/7.

STAY CONNECTED

For more up-to-date content from us
 why not follow our blog:
WWW.TABLECRAFT.COM/BLOG

Or follow us on social media:

-  /tablecraftEU
-  @tablecraftEU
-  @tablecraftEU
-  /tablecraft-products-company

REFERENCE AT THE READY

Be sure to check out TableCraft's global website! Our site is full of features and customised solutions to meet your foodservice and hospitality needs. Simply enter eu.tablecraft.com into your web browser or scan the QR code below to head directly to our homepage.



Scan to explore
eu.tablecraft.com

Easily translate our site into dozens of other languages

Find our US sites and Table Talk Blog here

The screenshot shows the TableCraft website interface. At the top, there's a navigation bar with links for HOME, PRODUCTS, CLEARANCE, RESOURCES, ABOUT TABLECRAFT EU/UK, CONTACT US, and FIND A SALES REP. Below the navigation bar is a large banner for 'THE 2024 CATALOGUE' with a 'Browse The Flipbook' button. Underneath the banner are three smaller promotional images: 'GET CONTROL THE PORTION CONTROL BROCHURE', 'FEEDING A CROWD 100S OF BUFFET SOLUTIONS', and a product listing for a 'PerfectGrip™ Y Peeler, Julienne Edge'.

Easily search for products

View our new digital catalogue here

Find great deals in our new Clearance section

Review Brochures, Sell Sheets & Catalogues all in one place

Check out our featured products and collections

10977
PerfectGrip™ Y Peeler,
Julienne Edge
Current Stock: 230
Sold in Multiples of: 1

Product listings include a Real Time Inventory tracker



Providing Solutions for over 75 Years
Every Ware. Every Day.



Scan to explore
eu.tablecraft.com

European Headquarters
27 Causeway Road, Corby
Northants. NN17 4DU

Customer Service: 01536 400091
salesuk@tablecraft.com

eu.tablecraft.com



©2024 TPC, Inc.

