

## FLEXIBLE SPACE SOLUTIONS

With INSIDE.BASE, INSIDE.CUBE, MEET.IN, TALK.BOX, QUIET.BOX, QUIET.BOX Duo, QUIET.BOX Duo XL, THINK.TANK and THINK.TANK.II

# SPACES WHERE PEOPLE CAN BE CREATIVE



# A world of work which is as flexible as you are

With the advent of new ways of working, individual offices and designated workstations are disappearing more and more from office landscapes. Teamwork, short pathways, quick meetings and a creative togetherness define everyday work and demand spaces for communication.

The question is simple: how do you allow for private space and provide the opportunity for individuals to withdraw at the same time? How is concentrated, quiet work possible?

**As an expert in office furniture and room systems with decades of experience, König + Neurath has answers to these questions.**

Allow us to convince you!

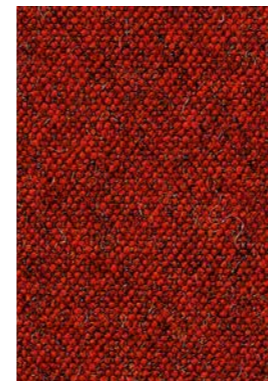

ALUMINIUM WITH A SMALLER CO<sub>2</sub> FOOTPRINT

The ASI-certified aluminium for our room systems is supplied by **Hydro REDUXA** and comes from Hydro's Norwegian smelters, who only use electricity from renewable sources (hydropower, wind and sun).



# INSIDE.BASE ROOM AND PRIVACY IN OPEN SPACE

Clever solutions for a complex problem. Just imagine that you have total freedom in the design. Where do we need privacy for phone calls? Where can teams meet to sort things out? And how can it all be reconfigured in a few hours? **The answer is INSIDE.BASE with its five model variants.**



Products:  
INSIDE.BASE Duo phone box, INSIDE.BASE concentration spot,  
stand-up meeting TABLE, pull-out sidefiler, QUICK.III, TALO.S and OKAY.II



Printed fabric ceilings are available

# THINKING AND WORKING OUTSIDE THE BOX INSIDE.CUBE

Work that doesn't feel like work. You want to attract the right employees for your business and motivate them to personal development? With us, you can enable work which is concentrated, creative and networked. **With INSIDE.CUBE, you have the possibility of creating a special room experience.** In harmonious colours, with clear shapes and a wide range of design options.



Products:  
INSIDE.CUBE, NET.WORK.PLACE Organic elements,  
NET.WORK.PLACE Lounge Chair, BASIC.4 and pedestals

# LET'S HAVE A MEET.IN

Open space management systems like our MEET.IN are an ideal way to create visual structure in your reception and lounge areas. These micro-houses are effective in more ways than one. For users they offer a quiet space with a pleasant atmosphere, while visually they evoke an attractive, homely feel.

MEET.IN is available as a solution for two or four people, with a back wall or open, and comes in a choice of finishes. It can be supplied with wall or desk lights to add a little luxury in the staff restaurant or cafeteria.



Products:  
MEET.IN and NET.WORK.PLACE elements



## 65 DECIBELS QUIETER TALK.BOX

A conversation at moderate volume measures 65 decibels. That's considered a background noise level that can certainly disrupt focused working. To help employees stay relaxed, productive and healthy, it's a good idea to install an acoustic solution in an open space office. **There are different options – one of which is our TALK.BOX.**

The innovative phone booth only takes up a single square metre of floor space and is very effective when it comes to limiting noise in the office. Its black profiles are made of sustainably produced aluminium, which adds an elegant touch in offices with a loft style.

Products:  
TALK.BOX, TALO.YOU Bench, OKAY.III, ACTA.PLUS,  
QUICK.III, MOVE.MIX bar stool

# QUIET.BOX CLEAR FORM, MORE PRIVACY

Even in busy places people need space to make phone calls undisturbed or to discuss confidential information.

**Our smallest and simplest solution to this problem is the QUIET.BOX.** It fits in harmoniously everywhere – even in passageways or canteens – with minimum impact. That's thanks to its understated design and optional transparent rear panel. We supply the QUIET.BOX as a ready-assembled piece of furniture, so you just have to put it up and plug it in. Ventilation, lighting and power connection are included!

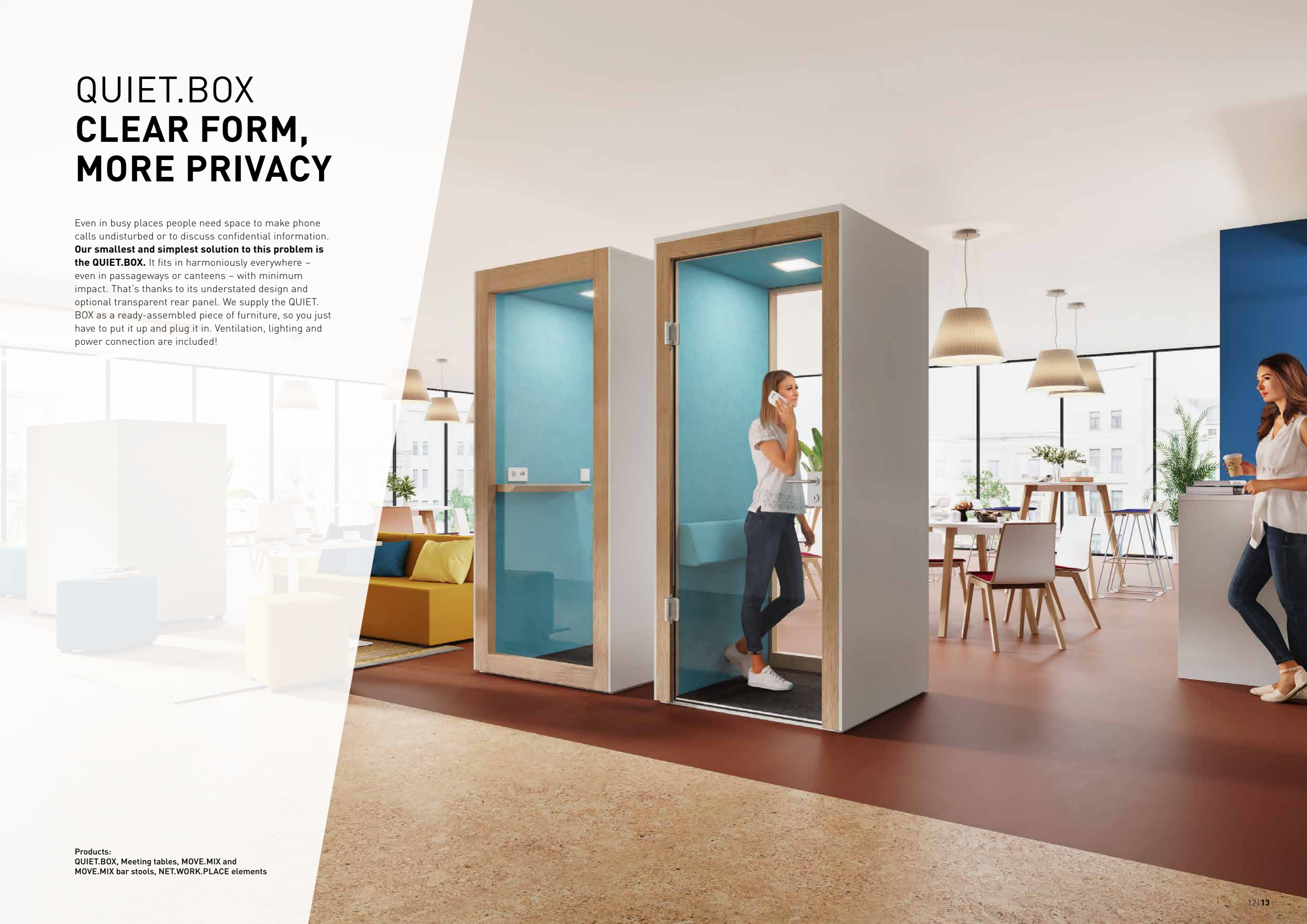

Products:  
QUIET.BOX, Meeting tables, MOVE.MIX and  
MOVE.MIX bar stools, NET.WORK.PLACE elements

# QUIET.BOX Organic A MODULAR APPROACH TO SPACE ORGANISATION

You don't necessarily need much space for privacy. Do you want to share personal or confidential information in an open space office? **Then you need to retreat to our QUIET.BOX Organic, which has a homely feel.** The textile, acoustically effective back panel can be designed individually. The organic design of this modern-day phone box makes it the perfect complement for the open space solutions in our NET.WORK.PLACE Organic suite.



Products:  
QUIET.BOX Organic, TENSA.NEXT,  
NET.WORK.PLACE Organic elements, THINK.TANK, HORIZONTE



# QUIET.BOX Duo Organic FOR FOCUSED WORKING AND MORE

Working in an open space brings teams closer together and encourages them to reach decisions quickly. But you're going to need areas suitable for discussions too, so that your employees still have a quiet atmosphere for tasks involving concentration. **The QUIET.BOX Duo is ideal for quick one-to-one meetings or focused working.** The solution is completely self-contained with its own ventilation and comes with a choice of furniture – for instance with bench seats and tables. The glass back panel creates a pleasant feeling of space. The fabric-covered internal walls and acoustic ceiling ensure perfect acoustics.

Products:  
QUIET.BOX Duo Organic, TENZA.NEXT, Meeting table,  
MOVE.MIX bar stools and NET.WORK.PLACE elements

# QUIET.BOX Duo XL JUST THINK BIGGER

Whatever your space situation and style – with the **QUIET.BOX Duo XL** we offer you a **Made in Germany room-in-room system that's quick to install and can be configured in many different ways.** This new addition to the QUIET.BOX Duo product family boasts an extra 30 cm in depth and has no floorplate so it's instantly ready for use, supplied with integral lighting and ventilation as well as in a wide selection of configuration options. Choose from our comprehensive range of décor finishes, fabrics and outfitting variants – to find the solution that's perfect for your premises, style and individual needs!



Products:  
QUIET.BOX Duo XL, QUICK.III, TALO.YOU and OKAY.III

# THINK.TANK THE MOST CREATIVE WAY TO ACHIEVE NEW USE OF SPACE

The foyer is the company's business card. We work together with our partners to create a representative area that reflects an impression of their individual work culture. If you include areas for privacy and meetings here, the productive work can start right in the entrance hall: our **THINK.TANK** is incorporated into the architecture of the room, the glass partitions allow a view of what's happening – and the inspirational **NET.WORK.PLACE** upholstered elements and whiteboards really help people get creative.

Products:  
THINK.TANK, DO IT.4,  
NET.WORK.PLACE elements

# FOR A CREATIVE MEETING CULTURE THINK.TANK

**Develop your vision of the ideal working environment. And realise it with our THINK.TANK.** We present to you our exclusive room-in-room concept as a high-end solution, which is designed and manufactured made-to-measure to meet your requirements. With it, you can design creative meeting rooms with high-quality materials, top of the range equipment and in all possible shapes and sizes. We support you all the way from the first idea through planning to the ready-to-use installation on site.



Products:  
THINK.TANK, NET.WORK.PLACE Organic elements,  
MOVE.MIX bar stools, TABLE Meeting, TALO.S Bench, JET.II

# THINK.TANK.II MORE TRANSPARENCY MORE OUTPUT!

Work is becoming increasingly less desk-based. Brainstorming sessions, agile work methods and established creative techniques call for the cumulative expertise of a versatile team. You can offer the right space for this with our **THINK.TANK.II**. This acoustically optimised retreat zone offers enhanced acoustic protection thanks to its double glazing, and can be stylishly integrated into open space areas.

Products:  
THINK.TANK.II, AURAY, TABLE.T conference table,  
NET.WORK.PLACE elements, TWO.2.BLOCK,  
QUIET.BOX and ACTA.PLUS lockers

*“The first step towards a better working culture is the choice of the correct furniture.”*

**INSIDE.BASE**

**INSIDE.CUBE**

**MEET.IN**

**TALK.BOX**

**QUIET.BOX**

**QUIET.BOX Organic**

**QUIET.BOX Duo**

**QUIET.BOX Duo Organic**

**QUIET.BOX Duo XL**

**QUIET.BOX Duo XL Organic**

**THINK.TANK**

**THINK.TANK.II**

# FORM FOLLOWS FUNCTION



**INSIDE.BASE**  
Allows you to fit out open plan offices with five fixed sizes of multifunctional area.

Short installation time.



**TALK.BOX**  
Our most compact room-in-room solution for making phone calls with sustainably manufactured aluminium profiles in black.

Quickly assembled on site.



**QUIET.BOX**  
Our smallest room-in-room solution, we supply it ready-assembled so you just have to put it in place.

No fitting work required.



**INSIDE.CUBE**  
A flexible room-in-room module to design offices and work zones for a wide range of requirements.

Medium length of installation time.



**MEET.IN**  
A house module with design potential: a range of back wall options, various enclosure colours, ceiling or desk lights, and much more

Short installation time.



**QUIET.BOX Organic**  
As space-saving as it's little sister: thanks to the modular construction it's quickly assembled on site.

Quickly assembled on site.

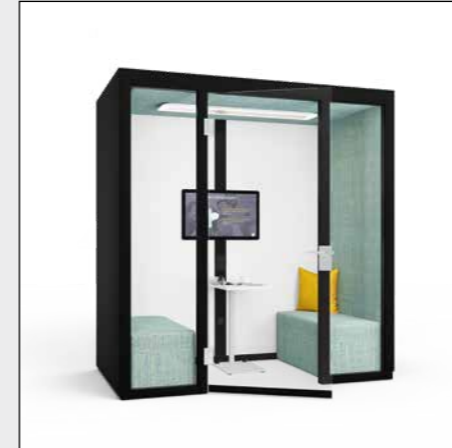

**QUIET.BOX Duo and QUIET.BOX Duo Organic**  
Enough space for two: an independent room, fitted with state-of-the-art technology. Dimmable lighting and ventilation via flat screen control. CO2 sensor also available.

Quickly assembled on site.



**QUIET.BOX Duo XL and QUIET.BOX Duo XL Organic**  
The QUIET.BOX Duo XL – our meeting solution for up to four people – is as quick and easy to install as the smaller variants.

Quickly assembled.



**THINK.TANK**  
Our high-end solution with which you create additional prestigious rooms within open space.

Longer installation time, but without impact on the building structure.



**THINK.TANK.II**  
Our high-end solution with double glazing is based on a modular concept and pre-assembled for quiet installation.

Short installation time, low noise and without impact on the building structure.

# FIVE MODELS FOR YOUR OFFICE LANDSCAPE

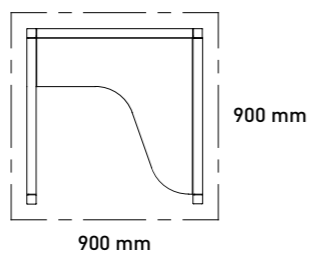

**PHONE BOX**  
The acoustically effective phone box is made from INSIDE.50 screens with glass top modules and a lightweight ceiling. It enables short periods of standing work or provides privacy for phone calls.

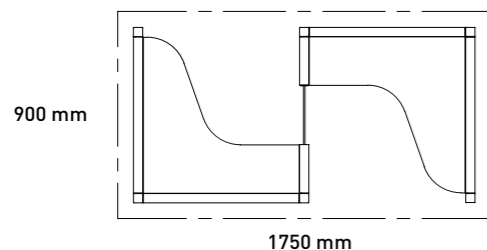

**PHONE BOX Duo**  
Our phone box for two people creates a shield while at the same time providing a view of the adjoining area. Ideal for limited floor areas.

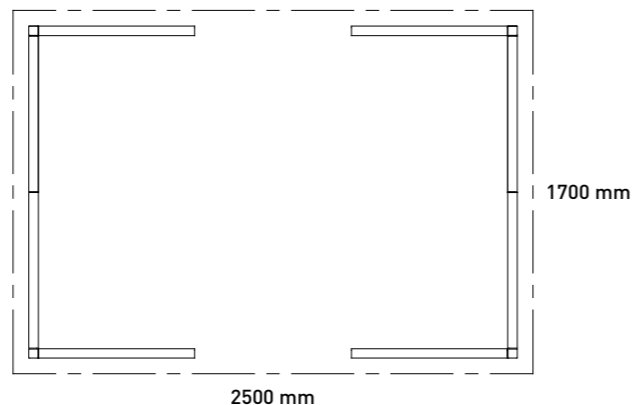

**TECHNOLOGY POINT**  
The Technology Point, with its glazed modules, optimum acoustics and light diffuser in the ceiling, provides a space for printers or other technical equipment and thus reduces the noise level across the whole floor.



**CONCENTRATION SPOT**  
This private area with light coming through glazed modules and a light diffuser in the ceiling greets you with an agreeable atmosphere and is suitable for phases of concentrated work or for spontaneous small meetings. The snail-shell structure improves the acoustic separation from the open-plan office.

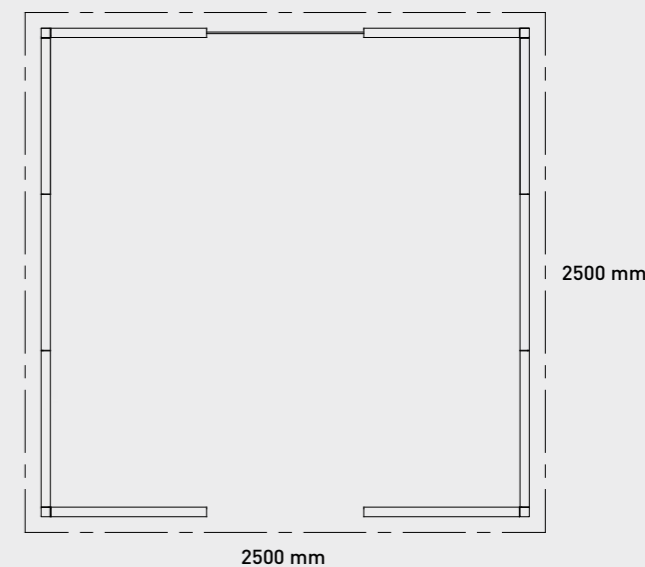
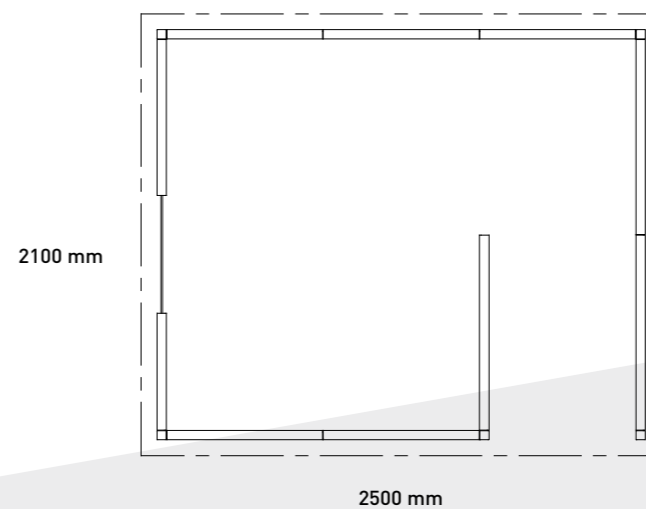

**MEETING POINT**  
A private room in an open design for spontaneous meetings. An agreeable atmosphere is provided by the glazed modules, the good acoustics and the light diffuser in the light-weight ceiling.



# DETAILS

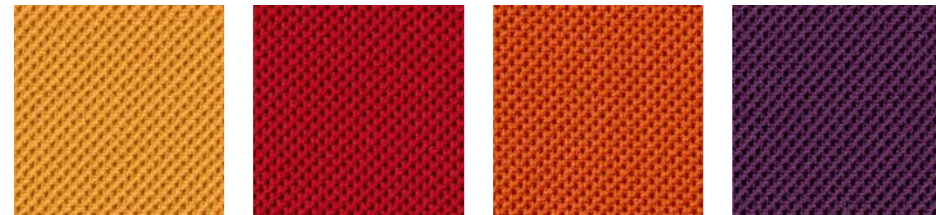

High-quality materials, long-lasting quality and a range of attractive new colours: our collection makes it easy for you to select light, harmonious and exciting combinations.

## 1 | ATTRACTIVE CEILING PANEL AND NATURAL LIGHT

The ceiling panel with the diffuser for effective light distribution is fitted on top of the glazed top modules. The glazed top modules are made from safety glass which amplifies the natural light, so that the room requires no additional lighting.

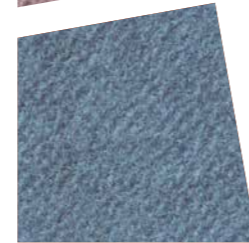
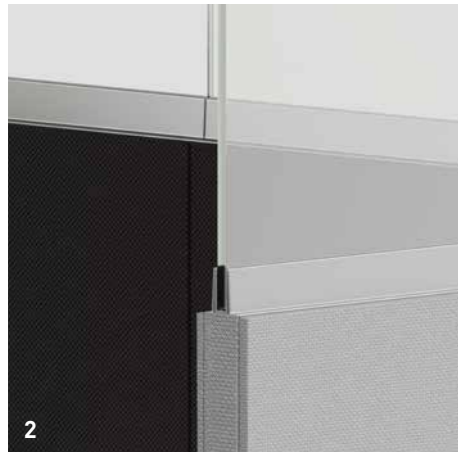
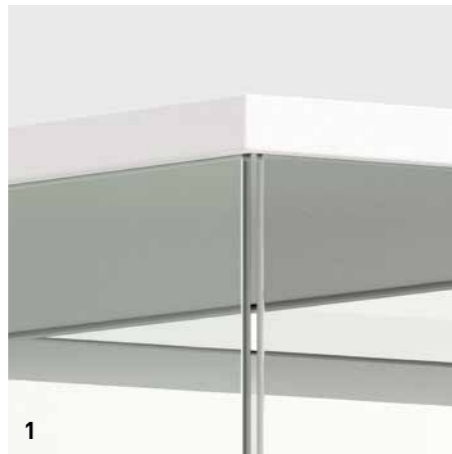

## 2 | ATTRACTIVE DUCT COVERS

The lateral duct covers and the flush construction give a quiet and elegant appearance to the structure.

## 3 | STURDY CORNER POSTS

The corners are sturdy and fabric-covered.

## 4 | LATERAL GLASS PANEL

The glass panel, which is clamped at the sides, offers a line of sight to the surroundings. It is used in the PHONE BOX DUO or in the MEETING POINT.

## 5 | CORNER DETAIL OF THE FLOOR CONNECTION

The adjustable feet let you alter the height of the floor connection.

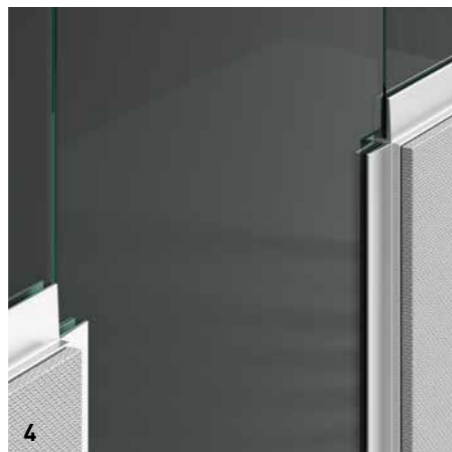

# PRODUCT OVERVIEW



## INSIDE.BASE

Description	Cubicle
<b>Technical details</b>	
Ceiling	Light-weight board with diffuser
Sizes	5 sizes
Wall configuration	Predefined
Absorption (echo)	Yes
Sound insulation	-
Door	-
Surface finishes	Fabric, see sample book
Ventilation	Passive ventilation (air circulation)
Climate control	-
Lighting	-
Glazed overpanels	Yes
Glazing	Enclosed
<b>Construction</b>	
Installation time (excl. transport)	3 - 4 hours
Reconfiguration on the same floor	4 - 5 hours
Construction	Low-noise
Flexibility	All components can be reused
Fastened to the floor of the building	-
Maximum size	2500 x 2500 mm
<b>Electrics</b>	
	In the solid walls (as with INSIDE.50)
<b>Sound insulation</b>	
	-

# MODULE OVERVIEW

## Ceiling construction

- + Acoustically effective, printable and easily exchangeable fabric ceiling
- + Modular prefabricated cassette structure
- + Integral ventilation ducts

## Installations

- + Circulating ventilation system with active supply and exhaust fans
- + Ventilation slots in the shadow gap
- + Ventilation ducts with acoustic modification
- + Wireless switches for simple installation

## Modular construction

- + Different basic sizes: special sizes on request
- + Internal lengths (can be combined): 1600 mm, 2400 mm, 2800 mm, 3200 mm
- + Modular construction offers a wide range of design options
- + Module grid: 200, 400, 600, 800, 1000 mm modules in fabric or glass
- + Fabric-covered basic structure (corners, ceiling brackets)
- + Planning instructions: only use fabric modules to connect to corner posts; only use fabric modules to connect to a door element; do not put 2 glass modules next to each other

## Fabric trims

- + Fabric selection from the K+N fabric collection, matching the screen
- + Glass modules in 8 mm VSG-S laminated safety glass
- + Cable management inside the modules via removable trims

## Installation and construction

- + The design requires no floor fixings
- + Quiet and easy assembly
- + Prefabricated modules allow rapid assembly
- + Can be completely taken down and re-erected at any time

## Door

- + Standard door 800 mm centre-to-centre in 8 mm safety glass
- + Acoustic seal via drop-down threshold seal
- + Door threshold for increased stability

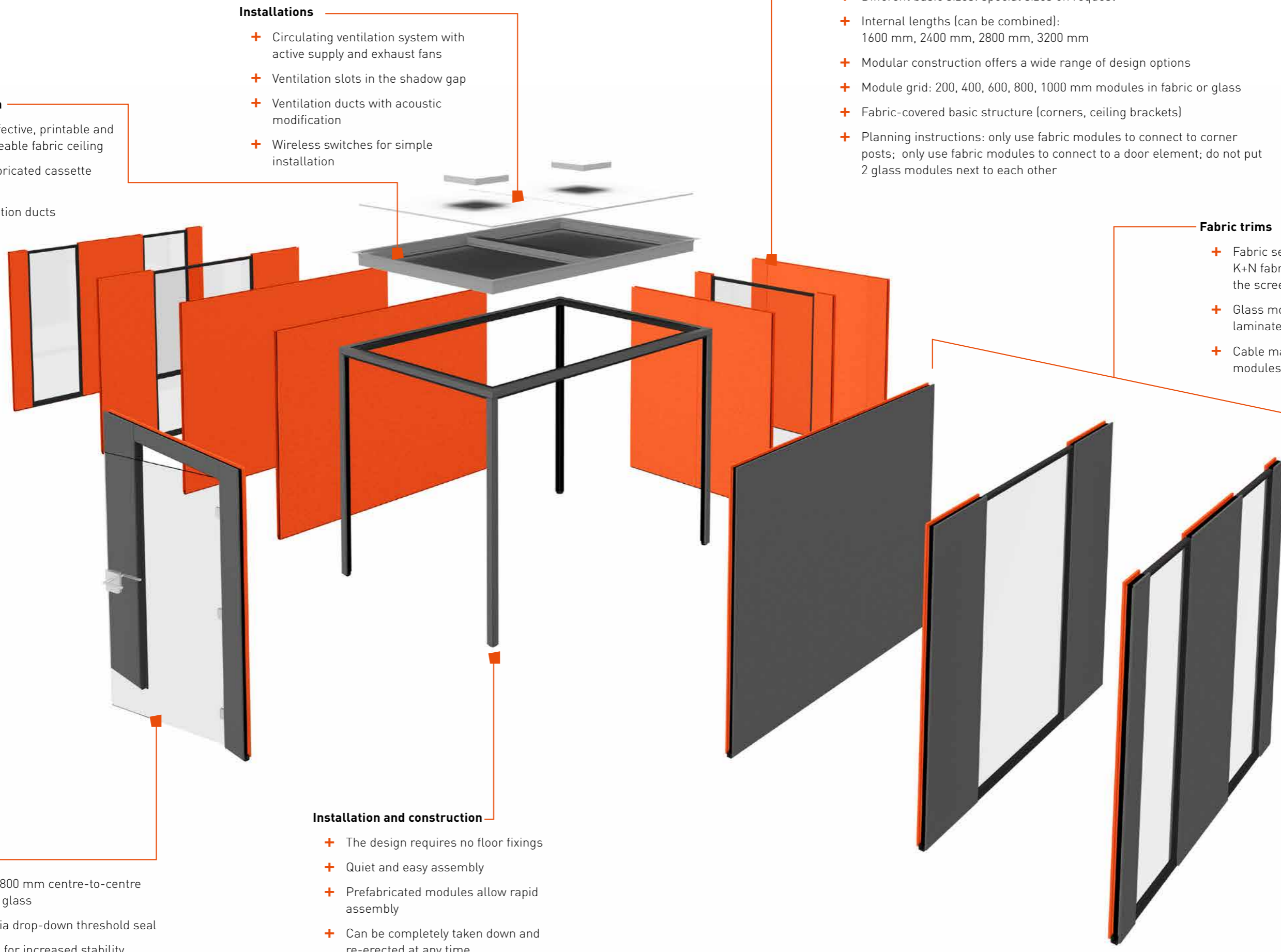

# DETAILS

## 1 | WELL-DESIGNED CORNER JUNCTION GLASS/FABRIC

The partly concealed module connection glass to fabric underpins the harmonious overall appearance.



## 2 | FINE CORNER DETAILS

And the completely fabric-covered corner junctions also fit into the overall appearance.

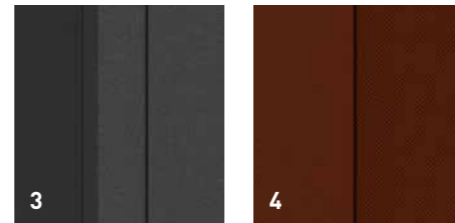
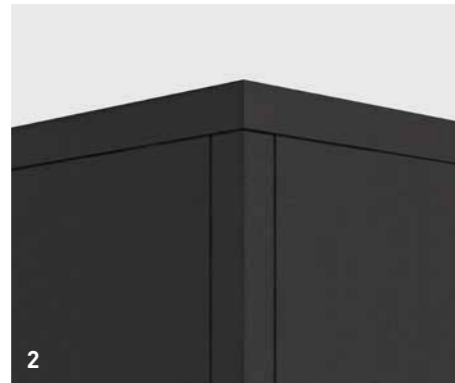

## 3 | FLUSH JUNCTION FABRIC/FABRIC

Good fabric/fabric junctions were part of the design brief.

## 4 | INTERNAL CORNER WITH FABRIC FACING

The concealed corner details allow a seam-free fabric cover; and the invisible construction produces fine corner junctions.



## 5 | PRINTABLE CEILING SAIL

The fabric ceiling with integral ventilation is available in white; on request, it can be printed in any pattern.

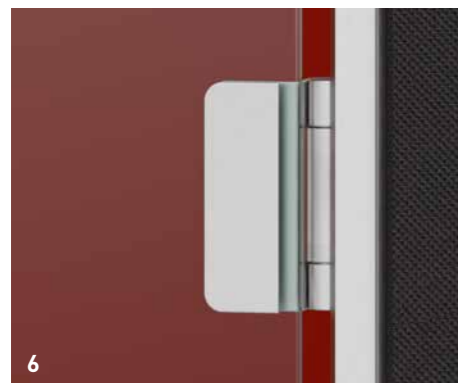

## 6 | A CONTRACT-QUALITY DOOR-FRAME

The door-frame is slim-line to match the system, and the door furniture is of contract quality.

## 7 | OPTIMISED CONTACT WITH THE FLOOR

The floor connection requires no fixings to the floor, is telescopic and designed for good acoustics.



## 8 | STABILISING THRESHOLD

The door has a threshold to increase the stability of the construction and to support the acoustic performance.

# PRODUCT OVERVIEW



## INSIDE.CUBE

Description	Room
<b>Technical details</b>	
Ceiling	Ceiling of stretched fabric
Sizes	12 sizes
Wall configuration	Modular, no restrictions on design
Absorption (echo)	Yes
Sound insulation	Yes, 32 dB
Door	Hinged door
Surface finishes	MFC, fabric from collection, whiteboard, acoustic etc.
Ventilation	Active ventilation (ventilator)
Climate control	Yes
Lighting	Ceiling lights and pendant lights are available
Glazed overpanels	-
Glazing	Glass modules
<b>Construction</b>	
Installation time (excl. transport)	Approx. half a day
Reconfiguration on the same floor	Approx. half a day
Construction	Low-noise
Flexibility	All components can be reused
Fastened to the floor of the building	-
Maximum size	Depth 3200 mm, length 3200 mm
Hight	2440 mm
<b>Electrics</b>	
	In the solid walls (as with INSIDE.50)
<b>Sound insulation</b>	
	Solid and glazed walls to 32 dB

# FAST AND FOCUSED MEETINGS

**CUSTOMISED**  
back wall design  
+ fabric-covered  
+ open (without back wall)  
+ whiteboard and blackboard from inside or outside

**LIGHTING**  
wall and table light options available

**SOLID PANELS**  
can be chosen from the K+N plastic/melamine finish collection (solid colour and wood effect)

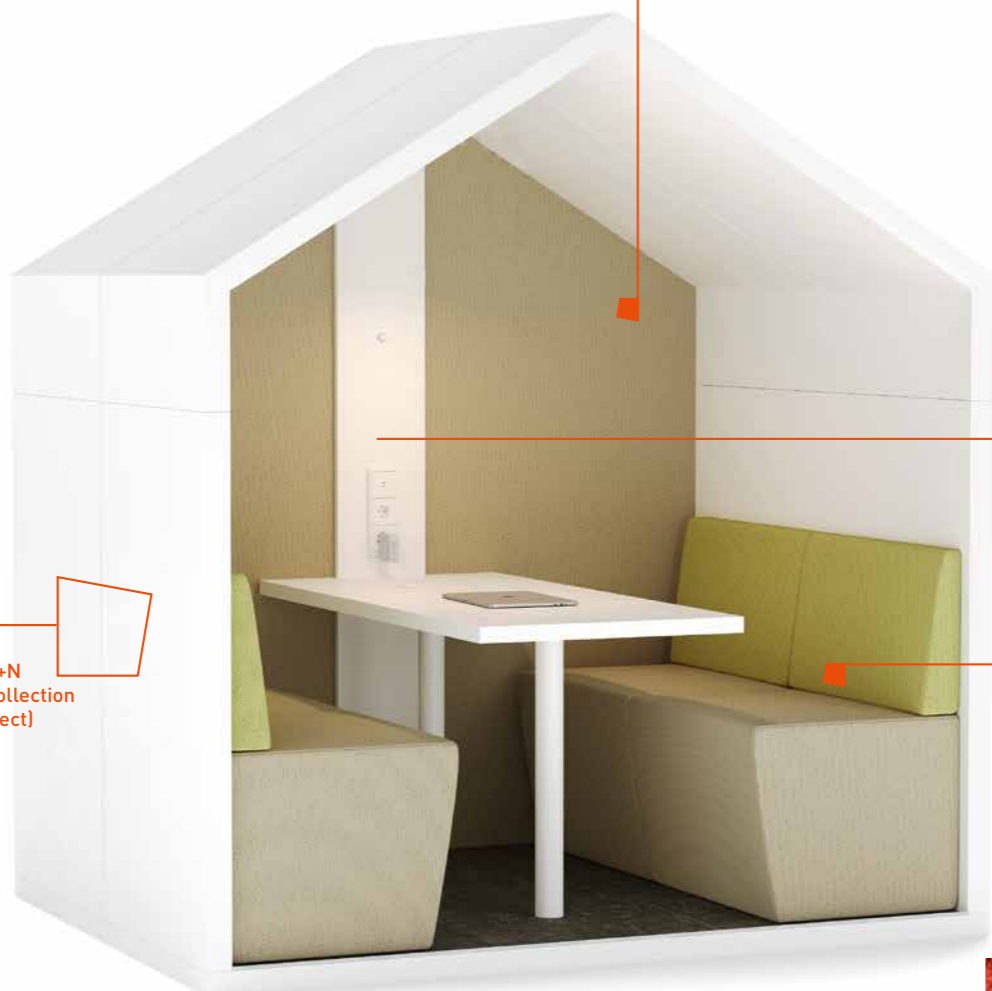
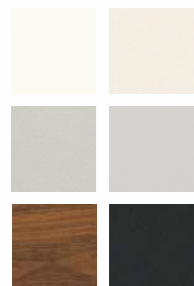

**POWER MODULE**  
with power and USB points

**FURNITURE**  
seating with back cushions and table

**FABRIC**  
from the K+N fabric collection (Economy 71, Standard 22 and 28, Comfort 92, or Premium 42, 46 and 49)

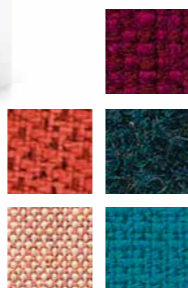

# PRODUCT OVERVIEW



	<b>MEET.IN (2-SEATER)</b>	<b>MEET.IN (4-SEATER)</b>
Description	Booth	Booth
<b>Technical details</b>		
Ceiling	Melamine pitched roof	Melamine pitched roof
Sizes	One variant	One variant
Wall configuration	Closed or open	Closed or open
Absorption (echo)	Optional ceiling sound absorber	Optional ceiling sound absorber
Sound insulation	-	-
Surface finishes	Free choice	Free choice
Lighting	Optional	Optional
Floor	Own floor with carpet	Own floor with carpet
<b>Construction</b>		
Installation time (excl. transport)	1 hour	1 hour
Reconfiguration on the same floor	1,5 hours	1,5 hours
Construction	Quiet / modular	Quiet / modular
Flexibility	All components can be reused	All components can be reused
Fastened to the floor of the building	-	-
Maximum size	750 x 2000 mm	1500 x 2000 mm
Height	2226 mm	2226 mm
<b>Electrics</b>		
	Closed variant with power module integrated centrally into back wall	Closed variant with power module integrated centrally into back wall

**Two models,**  
for 2 or 4 people

# BREAKOUT SPACE FOR DISCRETE TELEPHONE CALLS

**BUILT-IN LED**  
for uniform illumination.  
Controlled by presence  
detector.

**DOOR HINGES**  
3D-adjustable

**REAR WALL**  
Optionally available as a  
glazed unit (non-opening) 38 dB

**SOLID PANELS**  
Can be chosen from the K+N  
plastic/melamine finish collection  
(in solid colour and wood effect)  
Acoustic insulation level  $R_{w,p}$  42 dB

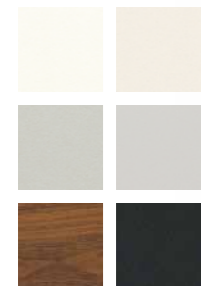

**VENTILATION**  
Ventilation and extraction through the  
shadow gap (left and right).  
Controlled by presence  
detector.



**TEXTILE INSIDE SURFACES**  
For an ideal interior acoustic  
choose from the K+N fabric  
collection (Economy 71, Standard 22  
and 28, Comfort 92, or Premium  
42, 46 and 49)

**STORAGE SHELF**  
With USB charging point and power  
socket, size 330 x 700 mm

**FITTINGS**  
Black to match profiles

**ACOUSTIC GLAZING**  
Door with acoustic insulation  
level  $R_w$  37 dB

**FRAME**  
Black, fine structure powder-coated

**FITS DIRECTLY TO THE FLOOR**  
Does not have its own floor,  
no edge to trip over

# PRODUCT OVERVIEW



	<b>TALK.BOX Angular profile</b>	<b>TALK.BOX Rounded profile</b>
Description	Room	Room
<b>Technische Angaben</b>		
Ceiling	Fabric	Fabric
Sizes	Fixed size	Fixed size
Wall configuration	Closed on 3 sides, or with glass back panel	Closed on 3 sides, or with glass back panel
Absorption (echo)	Yes	Yes
Sound insulation	Yes, 38 dB	Yes, 38 dB
Door	Glass door	Glass door
Surface finishes	Free choice	Free choice
Ventilation	Active ventilation (ventilators)	Active ventilation (ventilators)
Climate control	-	-
Lighting	Yes, ceiling light	Yes, ceiling light
Skylight	-	-
Glass panels	optional	optional
Floor	No built-in floor	No built-in floor
<b>Aufbau</b>		
Installation time (excl. transport)	3 hours	3 hours
Reconfiguration on the same floor	4,5 hours	4,5 hours
Construction	Sometimes noisy	Sometimes noisy
Flexibility	All components can be reused	All components can be reused
Fastened to the floor of the building	-	-
Maximum size	1106 x 1106 mm	1106 x 1106 mm
Height	2226 mm	2226 mm
<b>Electrics</b>		
	Yes, same side as writing tablet	Yes, same side as writing tablet
<b>Sound insulation</b>		
	Opaque walls 42 dB $R_{w,P}$ Glazing 38 dB $R_{w,P}$	Opaque walls 42 dB $R_{w,P}$ Glazing 38 dB $R_{w,P}$

# 1 M<sup>2</sup> QUIET ZONE FOR PERSONAL CONVERSATIONS



# PRODUCT OVERVIEW



	QUIET.BOX	QUIET.BOX Organic
Description	Room	Room
<b>Technical details</b>		
Ceiling	Fabric-covered	Fabric-covered
Sizes	Fix size	Fix size
Wall configuration	3 sides closed or glass back panel	3 sides closed or glass back panel
Absorption (echo)	Yes	Yes
Sound insulation	Yes, 38 dB	Yes, 38 dB
Door	Hinged glass door	Hinged glass door
Surface finishes	Inside fabric (see swatches), outside melamine	Inside fabric (see swatches), outside melamine
Ventilation	Active ventilation (ventilator)	Active ventilation (ventilator)
Climate control	-	-
Lighting	Yes, integral ceiling light	Yes, integrat ceiling light
Glazed overpanels	-	-
Glazing	Enclosed	Enclosed
<b>Construction</b>		
Installation time (excl. transport)	Pre-assembled approx. 30 minutes in kit form approx. 2-3 hours	Pre-assembled approx. 30 minutes in kit form approx. 1-2 hours
Reconfiguration on the same floor	30 minutes	30 minutes
Construction	Low-noise	Low-noise
Flexibility	All components can be reused	All components can be reused
Fastened to the floor of the building	-	-
Size	1000 x 1000 mm	1000 x 1000 mm
Hight	2226 mm	2226 mm
<b>Electrics</b>		
	In the solid walls	In the solid walls
<b>Sound insulation</b>		
	Solid walls up to 42 dB Glazed sections up to 38 dB	Solid walls up to 42 dB Glazed sections up to 38 dB

# PEACE AND QUIET FOR TWO

# COLOURS AND WOOD EFFECTS DETAILS



**CONTROL/ACCESSORIES**  
Customised equipment as required

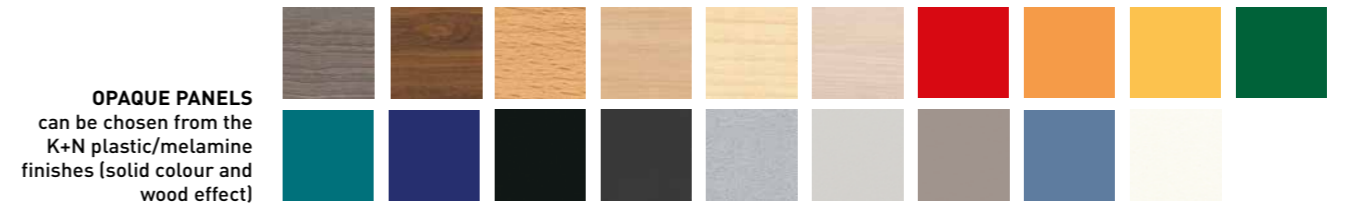

**OPAQUE PANELS**  
can be chosen from the K+N plastic/melamine finishes (solid colour and wood effect)



**PROFILES**  
Various colours, including RAL shades, to choose from



**FABRIC INNER SURFACES**  
Selection of fabrics



**1 | FABRIC CEILING**  
Acoustic properties



**2 | CEILING TRIM PROFILE**  
Neat covering for ceiling structure and concealed technology

**3 | OPERATING CONSOLE**  
Light and ventilation switches as standard version or available with touch function

**4 | DOOR HINGES**  
3D-adjustable in silver, optional in white or black

**5 | FLOOR CONNECTION**  
Flush-level entry

# QUIET ZONE FOR TWO – IN THREE VERSIONS



**INTERNAL VARIANT 1**  
Small meeting situation  
with integrated fabric-covered bench seats  
and side table.

Products:  
NET.WORK.PLACE bench and  
side table.



**INTERNAL VARIANT 2**  
Mini-office for focused working.

Products:  
MOVE.MIX bar stool and standing bridge



**INTERNAL VARIANT 3**  
Dynamic meeting situation for stand-up  
meetings.

Products:  
QUICK.III and side table.

# PRODUCT OVERVIEW



	<b>QUIET.BOX Duo</b>	<b>QUIET.BOX Duo Organic</b>
Description	Room	Room
<b>Technical details</b>		
Ceiling	Acoustic ceiling in wooden material	Acoustic ceiling in wooden material
Sizes	Fix Size	Fix Size
Wall configuration	Unrestricted design	Unrestricted design
Absorption (echo)	Yes	Yes
Sound insulation	Yes, 37-43 dB	Yes, 37-43 dB
Door	Hinged or sliding door	Hinged or sliding door
Surface finishes	Free choice	Free choice
Ventilation	Controllable, active ventilation	Controllable, active ventilation
Climate control	Yes	Yes
Lighting	Built-in and pendant lights are available	Built-in and pendant lights are available
Glazed top modules	Yes	Yes
Glass modules	Large areas	Large areas
<b>Construction</b>		
Installation time (excl. transport)	Approx. half a day	Approx. half a day
Reconfiguration on the same floor	Approx. half a day	Approx. half a day
Construction	Noisy	Noisy
Flexibility	All components can be reused	All components can be reused
Fastened to the floor of the building	Only in the door area	Only in the door area
Maximum size	2200 x 1200 mm	2200 x 1200 mm
Hight	2226 mm	2226 mm
<b>Electrics</b>		
	In the solid walls, corner posts, ceiling frame, door frame	In the solid walls, corner posts, ceiling frame, door frame
<b>Sound insulation</b>		
	Solid walls up to 43 dB, glazed sections up to 38 dB	Solid walls up to 43 dB, glazed sections up to 38 dB



# PEACE AND QUIET - FOR TWO TO FOUR

**BUILT-IN LED**  
for uniform illumination

**DOOR HINGES**  
3D-adjustable in silver,  
optional in white or black

**REAR WALL**  
Melamine, fabric or glazed

**SOLID SURFACES**  
choose from the K+N  
collection MFC (solid colour  
and wood-effect)  
Acoustic insulation level Rw 42  
dB

**ACOUSTIC GLAZING**  
with acoustic insulation level  
Rw 38 dB.  
Door Rw 37 dB

**CONTROL/ACCESSORIES**  
Customised equipment  
as required

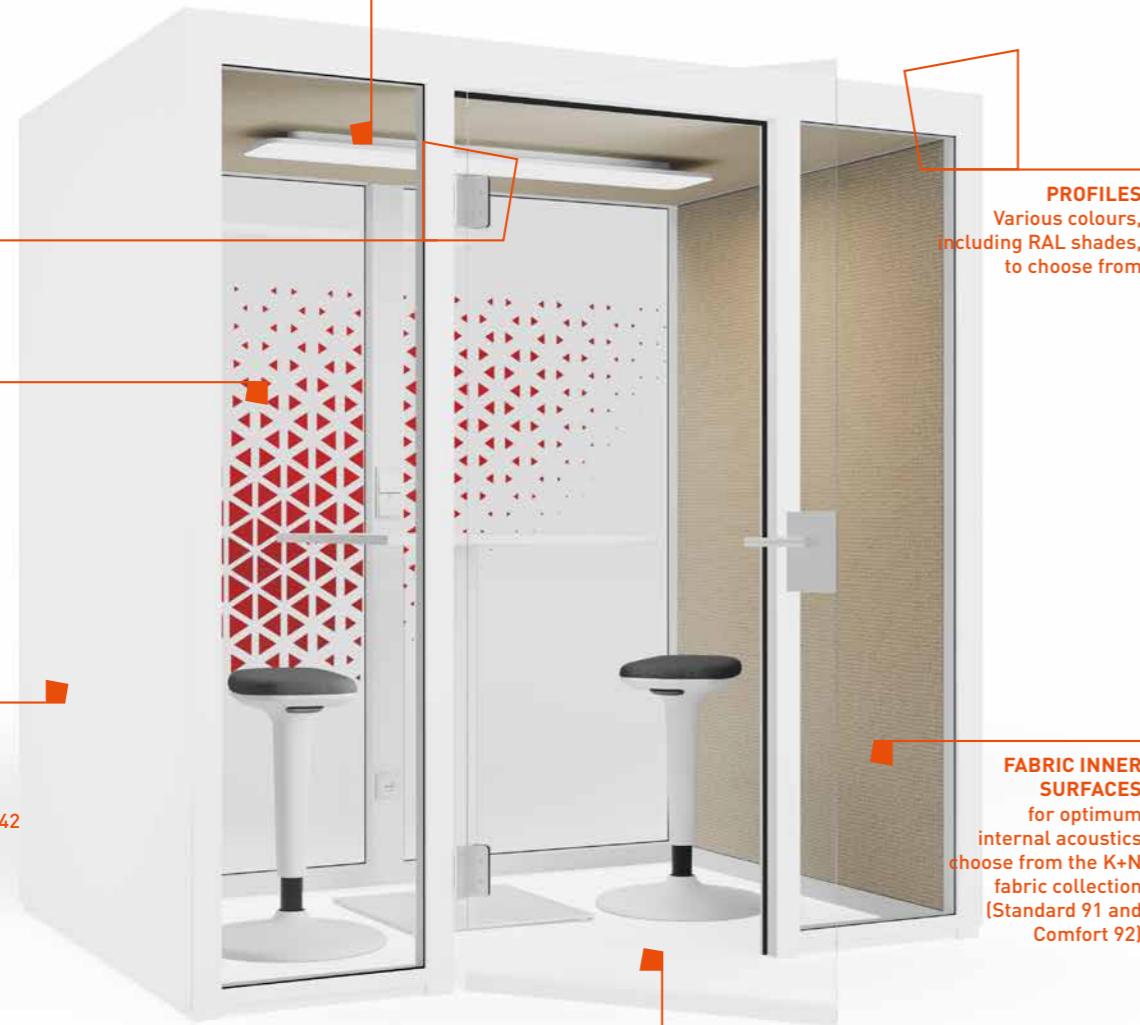

**PROFILES**  
Various colours,  
including RAL shades,  
to choose from

**FABRIC INNER SURFACES**  
for optimum  
internal acoustics  
choose from the K+N  
fabric collection  
(Standard 91 and  
Comfort 92)

# COLOURS AND WOOD EFFECTS DETAILS

**OPAQUE PANELS**  
can be chosen from the  
K+N plastic/melamine  
finishes (solid colour and  
wood effect)



**PROFILES**  
Various colours,  
including RAL shades,  
to choose from



**FABRIC INNER SURFACES**  
Selection of fabrics



Comfort  
92

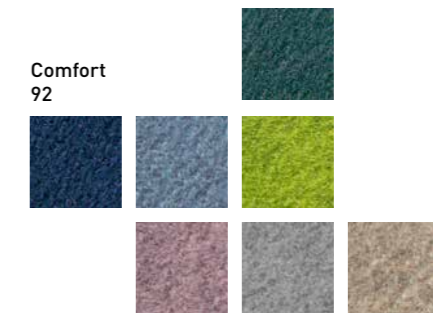

1 + 2

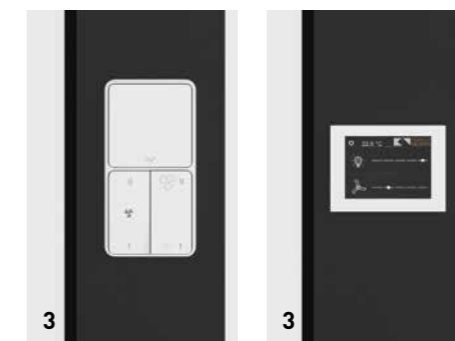

3

3

**1 | FABRIC CEILING**  
Acoustic properties



4



5

**2 | CEILING TRIM PROFILE**  
Neat covering for ceiling structure  
and concealed technology

**3 | OPERATING CONSOLE**  
Light and ventilation switches as standard  
version or available with touch function

**4 | DOOR HINGES**  
3D-adjustable in silver,  
optional in white or black

**5 | FLOOR CONNECTION**  
Flush-level entry

# QUIET ZONE FOR TWO TO FOUR IN THREE VERSIONS

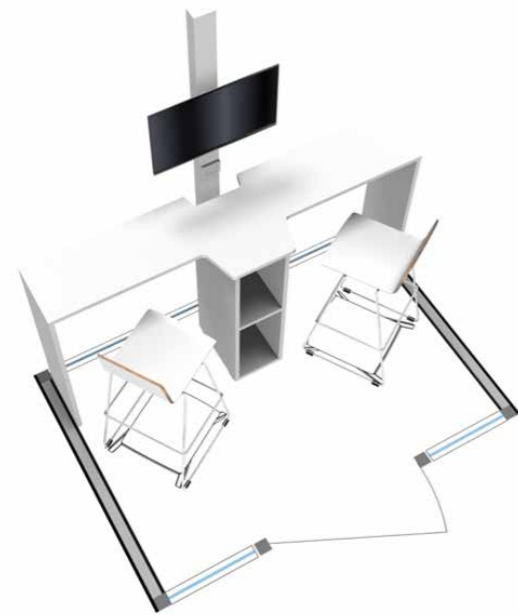

**INTERNAL VARIANT 1**  
Stand-up working  
QUIET.BOX Duo bridging desk  
Premium wiring package  
Electrical equipment: Conference

Other products:  
MOVE.MIX bar stool



**INTERNAL VARIANT 2**  
QUIET.BOX Duo standard stand-up table  
Basic II wiring package  
Electrical equipment: Work

Products:  
QUICK.III AND side table

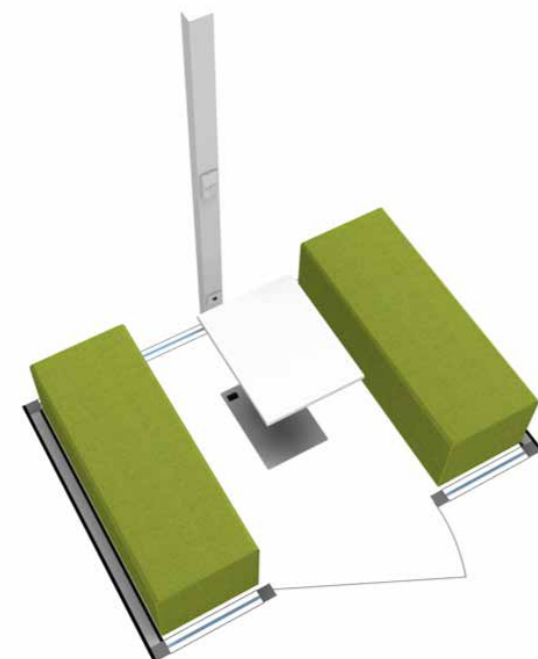

**INTERNAL VARIANT 3**  
Seated meeting  
QUIET.BOX Duo standard desk  
QUIET.BOX Duo bench seat  
Basic I wiring package  
Electrical equipment: Talk

Products:  
NET.WORK.PLACE bench and side table

# PRODUCT OVERVIEW



**QUIET.BOX Duo XL Organic**  
also available  
as a version with  
rounded corners

	<b>QUIET.BOX Duo XL</b>	<b>QUIET.BOX Duo XL Organic</b>
Description	Room	Room
<b>Technical details</b>		
Ceiling	Acoustic ceiling in fabric	Acoustic ceiling in fabric
Sizes	Fixed size	Fixed size
Wall configuration	2 variants	2 variants
Absorption (echo)	Yes	Yes
Sound insulation	Yes, 37-43 dB	Yes, 37-43 dB
Door	Hinged door	Hinged door
Surface finishes	Free choice	Free choice
Ventilation	Controllable, active ventilation	Controllable, active ventilation
Climate control	On request	On request
Lighting	Ceiling mounted light	Ceiling mounted light
Glazed overpanels	No	No
Glass modules	Large areas	Large areas
Floor	Does not have its own floor, barrier-free (Optional floor available)	Does not have its own floor, barrier-free (Optional floor available)
<b>Construction</b>		
Installation time (excl. transport)	3 - 4 hours	3 - 4 hours
Reconfiguration on the same floor	approx. 1/2 day	approx. 1/2 day
Construction	Noisy at times	Noisy at times
Flexibility	All components can be reused	All components can be reused
Fastened to the floor of the building	No	No
Size	2200 x 1500 mm	2200 x 1500 mm
Height	2226 mm	2226 mm
<b>Electrics</b>		
	Wired post in the centre of the rear wall	Wired post in the centre of the rear wall
<b>Sound insulation</b>		
	Solid walls up to 43 dB, glazed sections 38 dB	Solid walls up to 43 dB, glazed sections 38 dB

# MODULE OVERVIEW

## Door element

- + Available fully glazed, frame, solid leaf or sliding doors
- + Electro controls can be integrated into the door frame
- + Can be positioned at variable points in the walls

## Glass surfaces

- + Central, side or double glass structure possible
- + Optional transparent glazing joins without profile insert
- + Various glass styles can be selected if required

## Construction

- + Profile-based modular system
- + Sturdy post-and-rail construction
- + Aluminium-coloured or can be painted in RAL colours
- + Can be fully dismantled and reassembled
- + Plug-and-play-ready assembly by K+N

## Ceiling construction

- + Acoustically effective claddings made of wood composite
- + Multilayer construction
- + Insulated air channels
- + Simple integration of equipment required by customer
- + Integration of lighting is planned
- + Air recirculation system as standard

## Wall design

- + Free choice of wall/glass surface distribution
- + Multilayer structure
- + Diverse material and design options

## Wall trims

- + Interior spaces fully insulated
- + Free choice of cabling
- + Monitors can be fitted
- + Easy to fit switches and extra sockets

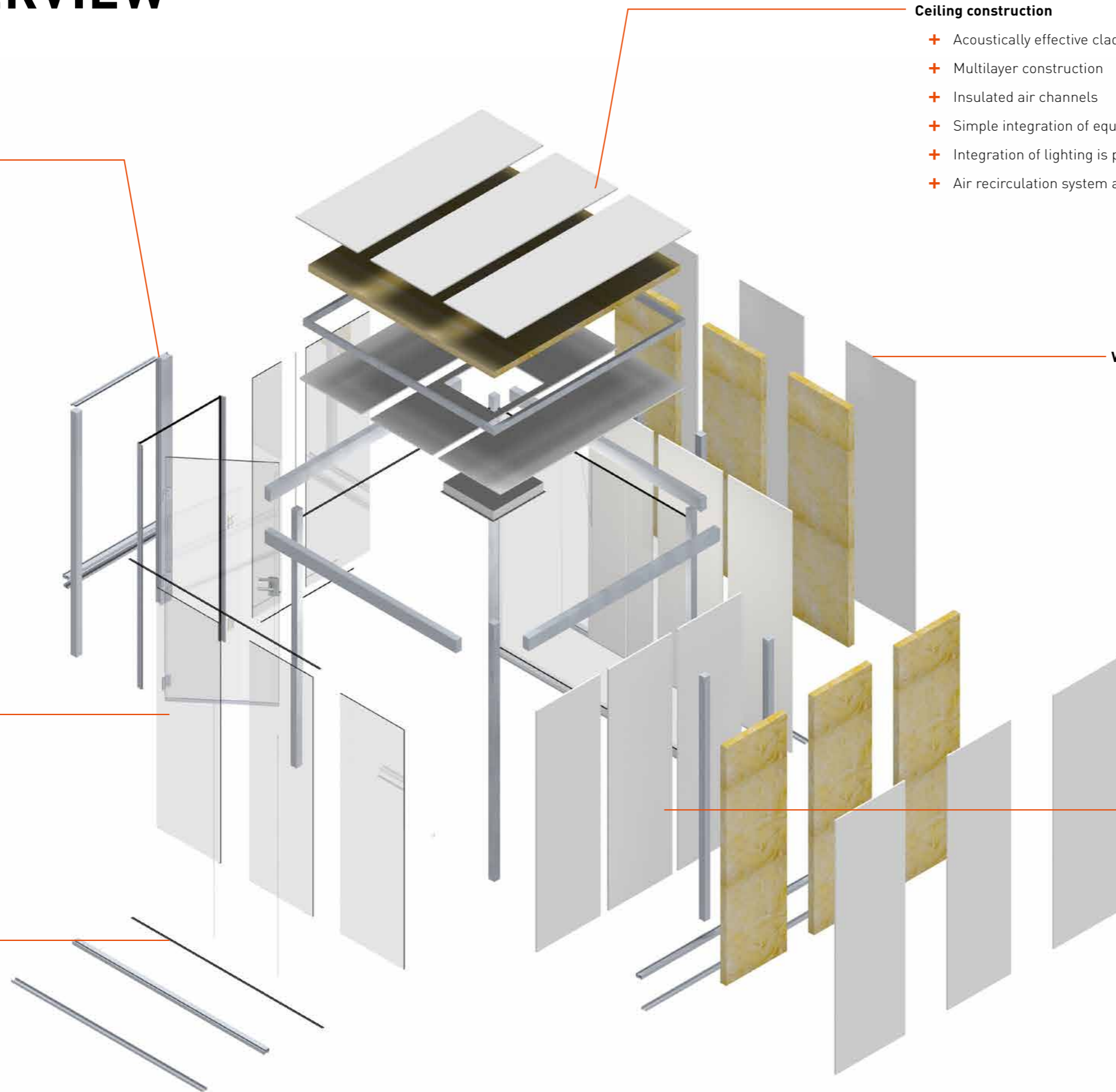

# DETAILS



**1 | LIGHTING**  
Lighting available as downlight or pendant light.



**2 | CEILING**  
Acoustic properties



**3 | CEILING TRIM PROFILE**  
Neat covering for ceiling structure and concealed technology.



**4 | VENTILATION OUTLET**  
concealed in the all-round shadow gap for optimum air exchange.

**5 | CORNER POSTS**  
Corner variant with delicate glazing joint or post.

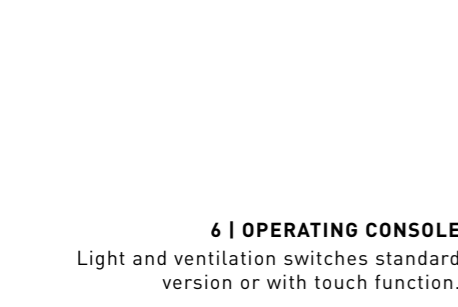

**6 | OPERATING CONSOLE**  
Light and ventilation switches standard version or with touch function.



**7 | DOOR HINGES**  
3D adjustable



**8 | GLAZING**  
Generous glass area with transparent glazing joint

**9 | FLOOR CONNECTION**  
Low floor connection, not offset.

# PRODUCT OVERVIEW



## THINK.TANK

Description	Room
<b>Technical details</b>	
Ceiling	Acoustic ceiling in wooden material
Sizes	Individual
Wall configuration	Unrestricted design
Absorption (echo)	Yes
Sound insulation	Yes, 32 – 43 dB
Door	Hinged or sliding door
Surface finishes	Free choice
Ventilation	Controllable, active ventilation
Climate control	Yes
Lighting	Built-in and pendant lights are available
Glazed top modules	Yes
Glass modules	Large areas
<b>Construction</b>	
Installation time (excl. transport)	Approx. 1 day
Reconfiguration on the same floor	Approx. 1 day
Construction	Noisy
Flexibility	All components can be reused
Fastened to the floor of the building	Only in the door area
Maximum size	Depth approx. 4000 mm, length unlimited
<b>Electrics</b>	
	In the solid walls, corner posts, ceiling frame, door frame
<b>Sound insulation</b>	
	Solid walls up to 48 dB, glazed sections to 43 dB

# SAMPLE SITUATIONS

**THINK.TANK 2400 x 2400 MM**

Our small solution for stand-up meetings, private conversations and focused working. You select the furniture and outfitting that suits your needs and the required work culture.

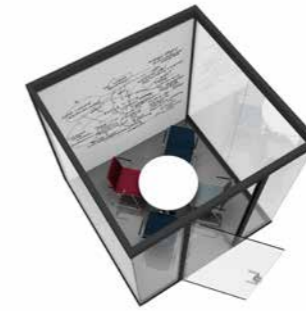
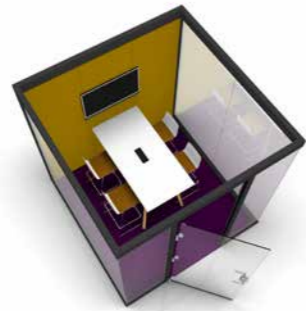

**THINK.TANK 4000 x 3200 MM**

Ideal for meetings with small groups, equally suitable as a separate lounge area, or an office that provides space for efficient working.



**THINK.TANK 6000 x 4000 MM**

Space for ideas. Formal meetings can be just as successful here as creative brainstorming. We offer you a selection of stylish furniture for diverse requirements.



**THINK.TANK 8400 x 4200 MM**

Your own work area. Large conferences can be held in this generously-sized room-in-room solution. We also offer you useful furnishing inspiration for seminars or creative areas.

# MODULE OVERVIEW

## Wall module

- + Organiser accessories and monitor mounting available
- + Wiring can be integrated in the modules
- + With reversible trims
- + Lots of design options (fabric, melamine, paint)

## Ceiling construction

- + Modular panelled ceiling for fast, quiet assembly
- + Acoustic properties
- + Integral ventilation
- + Pendant or ceiling mounted light available

## Glass modules

- + Supplied as complete modules
- + No need to bolt to the floor
- + Bonded glass surfaces (flush glazing)
- + Uniform thickness across all elements

## Module system

- + Preassembled for fast installation, low noise and dust

## System

- + Natural or coloured anodised finish
- + Individual size choice thanks to variable module width
- + Can be fully reversed and reassembled

## Door element

- + Ready-assembled module
- + Same thickness as glass elements, opaque modules not set back
- + Glass or opaque material

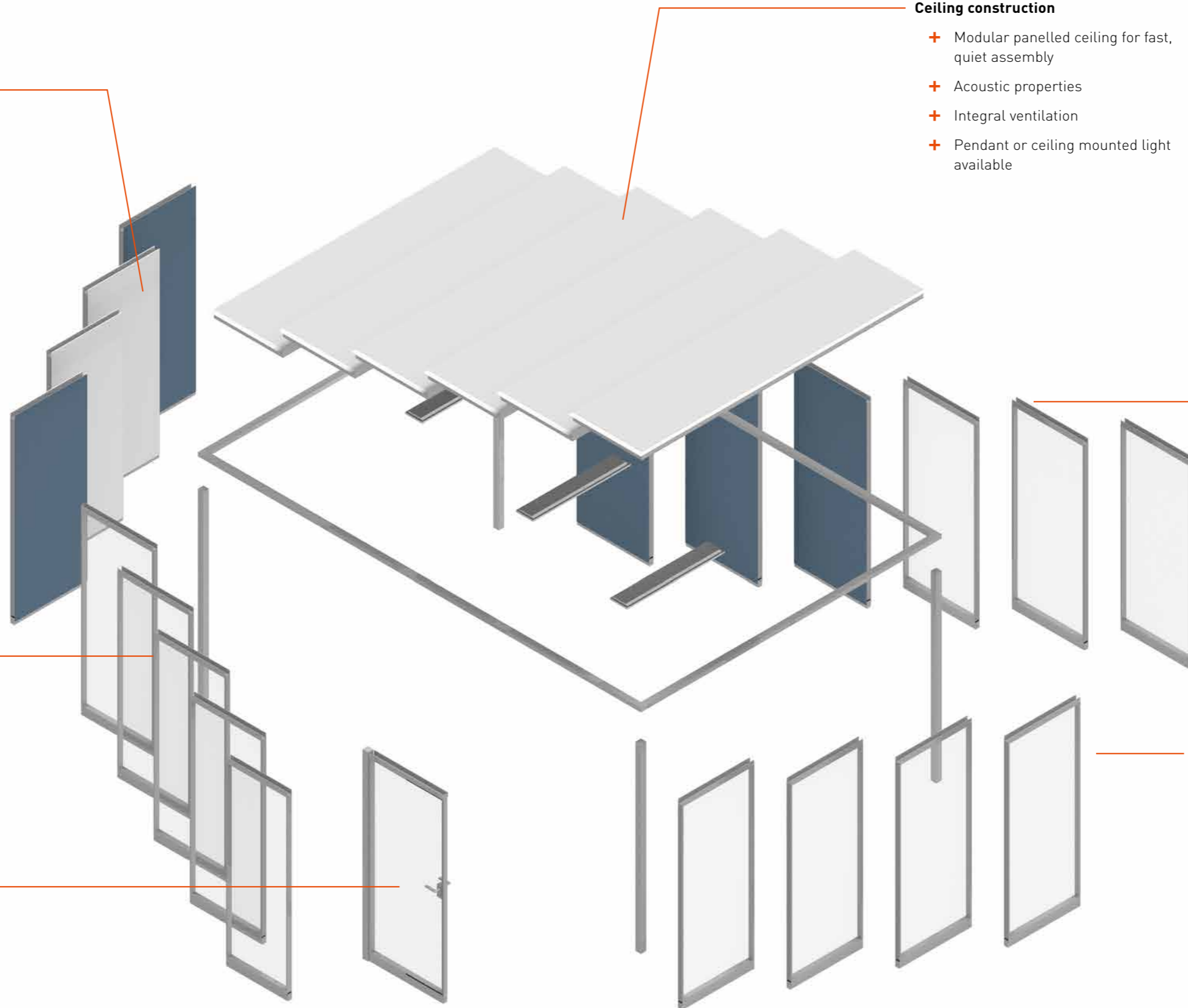

# DETAILS



**1 | LIGHTING**  
Lighting available as downlight or pendant light.

**2 | FABRIC CEILING**  
Acoustic properties

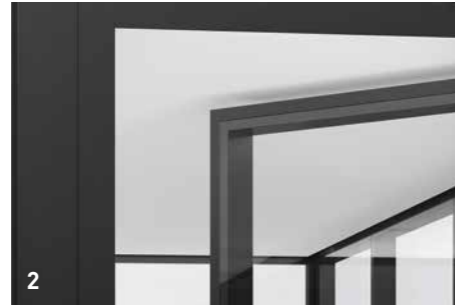

**3 | CEILING TRIM PROFILE**  
Neat covering for ceiling structure and concealed technology.



**4 | VENTILATION OUTLET**  
Concealed in the all-round shadow gap for optimum air exchange.

**5 | CORNER POSTS**



**6 | OPERATING CONSOLE**  
Light and ventilation switches standard version or with touch function.



**7 | DOOR HINGES**  
3D adjustable



**8 | UPPER DOOR CLOSER**  
Not visible when door is closed.



**9 | FLOOR CONNECTION**  
Low floor connection, not offset.

# PRODUCT OVERVIEW



## THINK.TANK.II

Description	Room
<b>Technical details</b>	
Ceiling	Ceiling of stretched fabric
Sizes	Individual
Wall configuration	Unrestricted design
Absorption (echo)	Yes
Sound insulation	Yes, 36-45 dB
Door	Hinged or sliding door
Surface finishes	Free choice
Ventilation	Controllable, active ventilation
Climate control	Yes
Lighting	Built-in and pendant lights are available
Glazed top modules	Yes
Glass modules	Glass modules
<b>Construction</b>	
Installation time (excl. transport)	Approx. half a day
Reconfiguration on the same floor	Approx. half a day
Construction	Low-noise
Flexibility	All components can be reused
Fastened to the floor of the building	Only in the door area
Maximum size	Depth approx. 4000 mm, length unlimited
<b>Electrics</b>	
	In the solid walls, corner posts, ceiling frame, door frame
<b>Sound insulation</b>	
	Solid walls up to 45 dB, glazed sections up to 45 dB

# MADE BY KÖNIG + NEURATH

YOU WILL FIND ALL THE PRODUCTS SHOWN HERE IN THE CATALOGUE



**NET.WORK.PLACE Organic**  
Optimum conditions for a better way of working.



**TENSA.NEXT**  
The next generation



**MEETING TABLE and MOVE.MIX**  
The special mix for spontaneous meetings standing up.



**TALO.YOU**  
A desk system that changes with you.

As a leading brand for office furniture and room systems, König + Neurath develops solutions for individual work cultures.

Together with specialist retailers, König + Neurath supports its customers throughout the entire process of outfitting offices. With differentiated style collections, design-conscious furniture and digital solutions, the family-owned company, established in 1925, helps its customers to adapt successfully to the changing nature of the workplace.



## Deutschland

König + Neurath AG  
Industriestraße 1-3  
61184 Karben  
T +49 6039 483-0  
info@koenig-neurath.de

## Great Britain

König + Neurath (UK) Ltd.  
Ground and Lower Ground Floor  
75 Farringdon Road  
London EC1M 3JY  
T +44 20 74909340  
info@koenig-neurath.co.uk

## Nederland

König + Neurath Nederland  
Beethovenstraat 530  
1082 PR Amsterdam  
T +31 20 4109410  
info@konig-neurath.nl

## France

König + Neurath AG  
53, rue de Châteaudun  
75009 Paris  
T +33 1 44632393  
info@koenig-neurath.fr

## Schweiz

König + Neurath (Schweiz) GmbH  
St. Gallerstrasse 106 d  
CH-9032 Engelburg / St. Gallen  
T +41 52 7702242  
info@koenig-neurath.de

## Österreich

König + Neurath AG  
Gonzagagasse 1 / Morzinplatz  
1010 Wien  
T +43 676 4117512  
info@koenig-neurath.de

