

Ledaks[®]

LED AYDINLATMA PROFİLLERİ & AKSESUARLARI

2025

- * LED BAR - IŞIK BANDI ALM. PRF. ve AKSESUARLARI sf ; 1-19 aralığı
- * Led Lighting alm. profiles and accessories pg; 1-19
- * DOKUNMATİK - HAREKET SENSÖRLERİ sf ; 7-8
- * Touch - Motion Switches pg; 7-8
- * İÇ MEKAN, SIVA ALTI - ÜSTÜ, PLASTİK PRF. ve AKSESUARLARI sf ; 16
- * Indoor - Outdoor Plastic Profiles and Accessories pg; 16
- * İÇ MEKAN, AVİZE PROFİL ve AKSESUARLARI sf ; 20-27 aralığı
- * Indoor Chandelier Profiles and Accessories pg; 20-27
- * İÇ MEKAN, L KÖŞE (45°) ALÜMİNYUM PROFİL ve AKSESUARLARI sf ; 28-29
- * Indoor Corner (45°) Aluminium Profiles and Accessories pg; 28-29
- * İÇ MEKAN, LED BAR-IŞIK BANDI ALM. PRF. ve AKSESUARLARI sf ; 30-41 aralığı
- * Indoor, Led lighting Aluminium Profiles and Accessories pg; 30-41
- * İÇ-DIŞ, MEKAN AYDINLATMA ALÜMİNYUM PRF. ve AKSESUARLARI sf ; 42-48 aralığı
- * Indoor - Outdoor Lighting Aluminium Profiles and Accessories pg; 42-48
- * POLİKARBON YUVARLAK PROFİLLER - ALÜMİNYUM KAYNAK TELLER sf ; 43
- * Polycarbon round Profiles - Aluminum welding wires sf; 43
- * İÇ-DIŞ MEKAN, ETANJ ALÜMİNYUM PRF. ve AKSESUARLARI sf ; 49-55 aralığı
- * Indoor - Outdoor Etange Aluminium Profiles and Accessories pg; 49-55
- * İÇ MEKAN, LİNEER - SIVA ÜSTÜ ALÜMİNYUM PRF. ve AKSESUARLARI sf ; 56-59 aralığı
- * Indoor Lineer - Over Plaster Aluminium Profiles and Accessories pg; 56-59
- * İÇ MEKAN, LİNEER - SIVA ÜSTÜ ALÜMİNYUM PRF. ve AKSESUARLARI sf ; 60-74 aralığı
- * Indoor Lineer - Over Plaster Aluminium Profiles and Accessories pg; 60-74
- * SIVA ALTI ALÇIPAN, LED AYDINLATMA ALÜMİNYUM PROFİL ve AKSESUARLARI sf ; 75-79 aralığı
- * Drywall, Aluminium Profiles and Accessories pg; 75-79
- * İÇ MEKAN, SIVA ALTI - ANKASTRE ALÜMİNYUM PRF. ve AKSESUARLARI sf ; 80-87 aralığı
- * Indoor Lineer - Under Plaster-Recessed Aluminium Profiles and Accessories pg; 80-87
- * DIŞ MEKAN, WALLWASHER ALÜMİNYUM PROFİL ve AKSESUARLARI sf ; 88-95 aralığı
- * Outdoor Wall Washer Aluminium Profiles and Accessories pg; 88-95
- * DIŞ MEKAN, SOKAK ARMATÜR KASALARI sf ; 96-97
- * Outdoor Street Lighting Cases pg; 96-97
- * DIŞ MEKAN, PROJEKTÖR KASA ALÜMİNYUM PROFİLİ ve AKSESUARLARI sf ; 98-104 aralığı
- * Outdoor Projector - Flood Light Cases of Aluminium Profiles and Accessories pg; 98-104
- * REKLAM PROFİLLERİ sf ; 40-105
- * Advertisement Profiles pg; 40-105
- * KUTU - SÜRÜCÜ - SİGMA - BORU ALÜMİNYUM PROFİLLERİ sf ; 106-107
- * Box - Driver - Sigma - Tube Aluminium Profiles pg; 106-107
- * DAİRESEL ALÜMİNYUM SOĞUTUCU PROFİLLER sf ; 108-119 aralığı
- * Aluminium Round Heatsink Profiles pg; 108-119
- * DÜZ - KOMPONENT ALÜMİNYUM SOĞUTUCU PROFİLLERİ sf ; 120-134 aralığı
- * Aluminium Flat - Component Heatsink Profiles pg; 120-134

YENİ ÜRÜNLER

YA-032 sf:9 ,YS-925 sf:10 ,YA-034 sf:14 ,YP-001 sf:15 , AVZ-BE 5 sf:26 , YA-027 , YA-030 sf:29
YA-033 sf:30 . YA-049 Y sf:36 , YA-091 Y sf:37 , YA-PB 40 50 60 70 sf:43 , YA-1201 1202 sf:49 ,
YA-215 YA-213 D:sf:56 ,YA-217 sf:57 ,YA-219 s:58 ,YA-221 226 sf:59 ,YA-ALC 01 sf:76 ,YA-035 S sf:77
YA-50 S sf:78 , YA-G 19 sf:80 , YA-211 sf:85 , AYS-67 sf:109 , ADS-79 sf:119 , ADS-292 sf:124

2024-2 KATALOGDAKİ YENİ ÜRÜNLER

YA-SR 01, YA-SR 11, YA-SR 12 sf:10/A , YA-046, YA-046 A sf:14/A , YA-204 DB, YA-204 DÇ sf:47
YP-002, PC-001 sf:16 , AVZ-018 sf:25 , MD-457 sf:37 , YA-227 sf:64/A , YA-G75 EKO sf:85/A



Copyright 2024 Tüm hakları Saklıdır
LEDAKS, katalogdaki ürünleri / ölçüleri herhangi bir ön bilgi vermeden değiştirebilir.

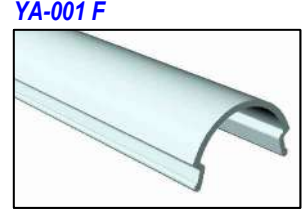
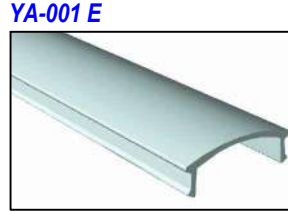
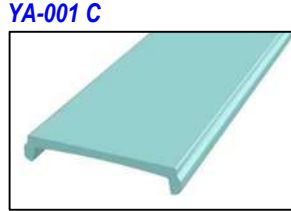
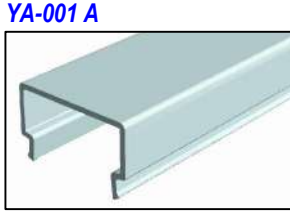
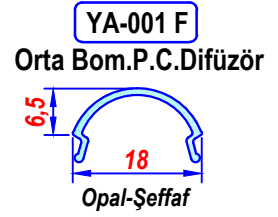
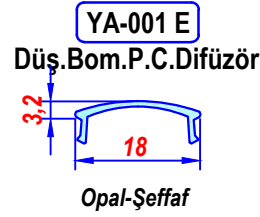
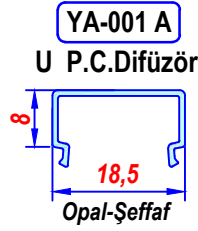
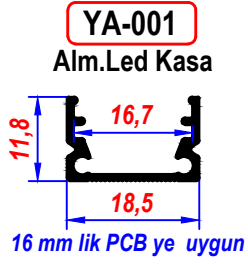

PC.DİFÜZÖR-ALM.PRF. 610 cm

PC.DİFÜZÖR, OPAL-ŞEFFAF

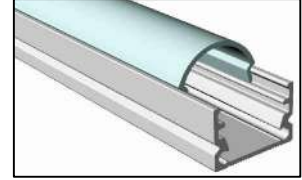
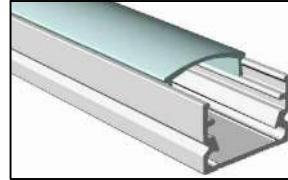
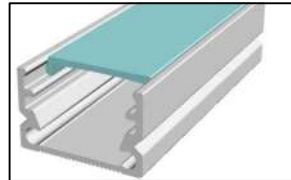
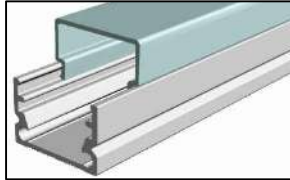

YA-001 YA-001 A

YA-001 YA-001 C

YA-001 YA-001 E

YA-001 YA-001 F

YA-001 A1

Yüksek Köşeli Pls.Tapa

Beyaz



YA-001 A PC ye uygun

YA-001 C 1

Pls. Kenar Tapa

A.Gri



YA-001 C ye uygun

YA-001 E 1

Düşük Bom.Plis. Tapa

A.Gri



YA-001 E ye uygun

YA-001 F 3

Orta Bombeli Plis. Tapa

Beyaz



YA-001 F PC ye uygun

YA-001 A2

Yüksek Köşeli Pls.Tapa

Beyaz



YA-001 A PC ye uygun

YA-001 S

ON-OFF Switch

Beyaz



YA-001 A1 YA-001 F3 de kullanılır

YA-001 F 1

Orta Bombeli Plis. Tapa

A.Gri



YA-001 F ye uygun

YA-001 F 2

Orta Bombeli Plis. Tapa

KULAKLI-DÜĞMESİZ



YA-001 F PC ye uygun

YA 001 A1-YA 001 A2 - YA 001 S UYGULAMASI

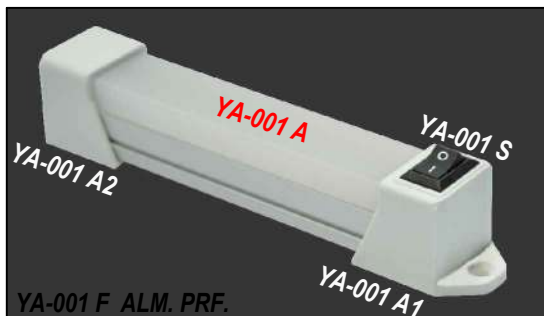

YA 001 F2-YA 001 F3 - YA 001 S UYGULAMASI



İstenilen ölçülerde kesim yapılır - İstenilen renge boyanır
All cutting dimensions and surface coatings can be done according to requirements

YA-001 A3

Yük. Köş. Alm.Tapa

Lazer Ken. Tapa



YA 001 A Uygun

YA-001 D

Alm.Duvar Bağlt. Aprt.

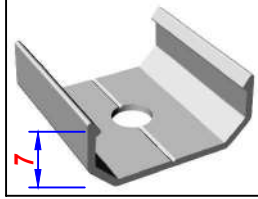

GEN. 20,5 mm

YA-001 D 1

Duvar Bağlt. Aprt.

ÇELİK



GEN. 18,5 mm

YA-001 D 2

Duvar Bağlt. Aprt.

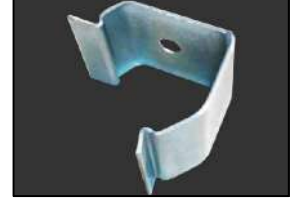

ÇELİK - 45° Köşeler için

YA-001, YA001 A PC.DİFÜZÖR UYGULAMASI

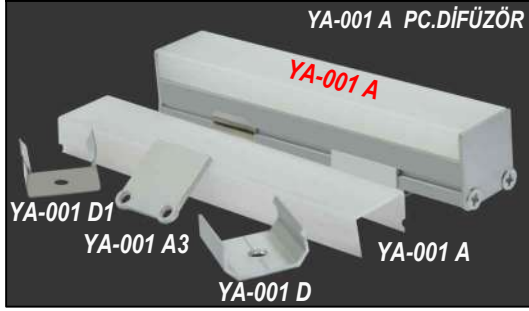

YA-001, YA001 C PC.DİFÜZÖR UYGULAMASI

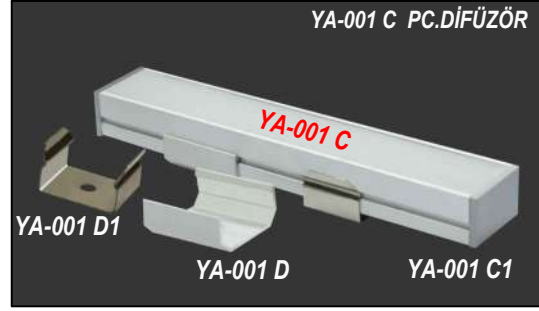

YA-001, YA001 E PC.DİFÜZÖR UYGULAMASI

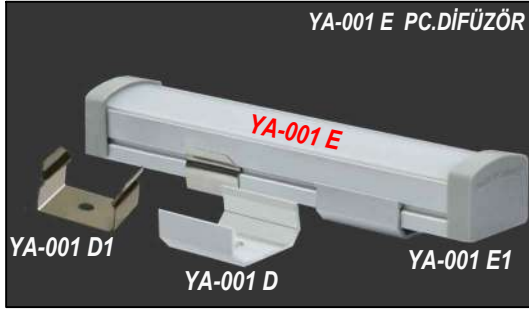

YA-001, YA001 F PC.DİFÜZÖR UYGULAMASI

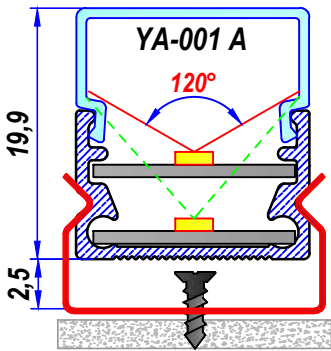
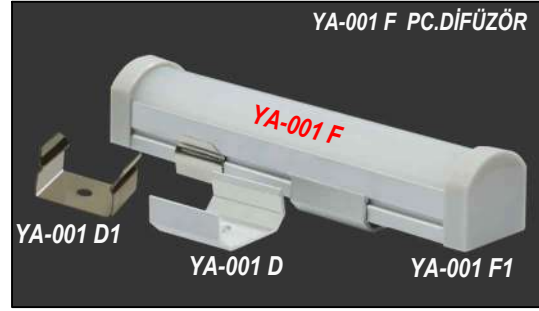

ZEMİN-DUVAR-MOBİLYA
YA-001 D1 MONTAJ

MONTAJ

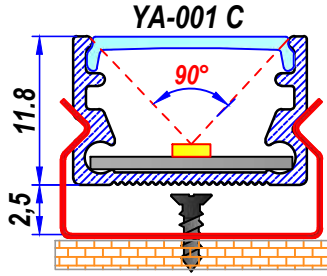

ZEMİN-DUVAR-MOBİLYA
YA-001 D1 MONTAJ

YA 001-YA 001 F PC cam, 45° UYGULAMA

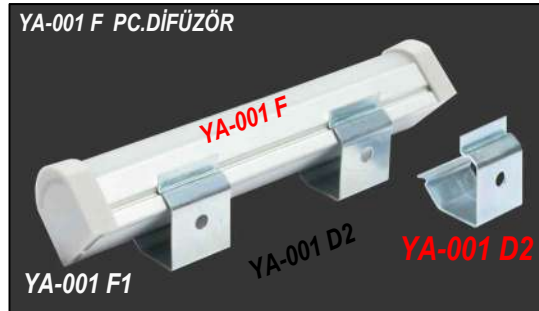

Köşelerde 45° açılı ışık

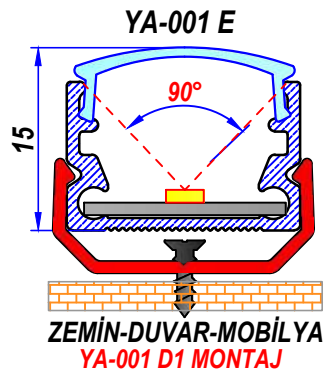

ZEMİN-DUVAR-MOBİLYA
YA-001 D1 MONTAJ

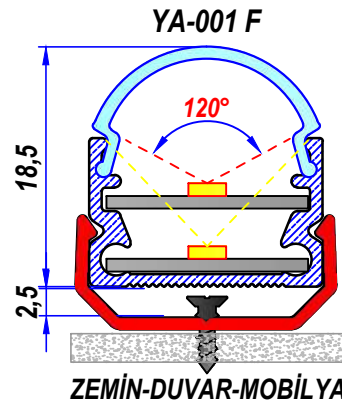

ZEMİN-DUVAR-MOBİLYA

MONTAJ

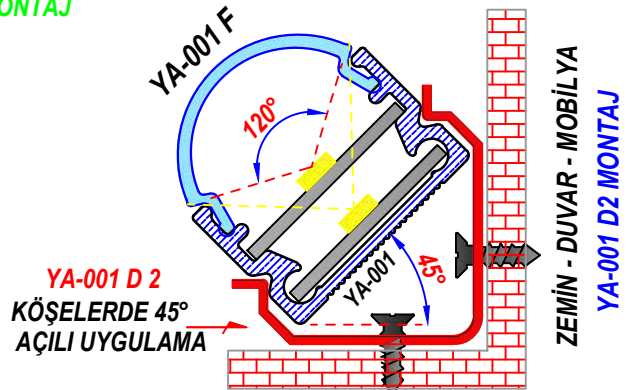

ZEMİN - DUVAR - MOBİLYA
YA-001 D2 MONTAJ

YA-003

Alm.Led Kasa

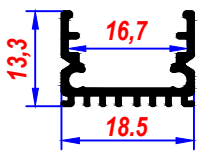

16 mm lik PCB ye uygun
Soğutma Kapasitesi yüksek

YA-001 A

U P.C.Difüzör

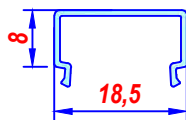

Opal-Şeffaf

YA-001 C

Düz P.C.Difüzör



Opal-Şeffaf

YA-001 E

Düş.Bom.P.C.Difüzör

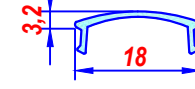

Opal-Şeffaf

YA-001 F

Orta Bom.P.C.Difüzör

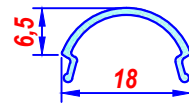

Opal-Şeffaf

YA-001 A

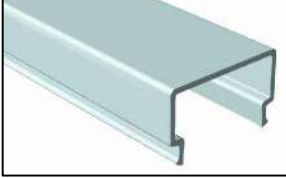

YA-001 C



YA-001 E



YA-001 F



YA-003

YA-001 A

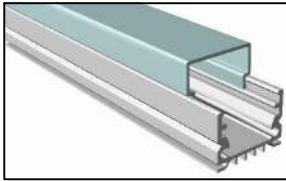

P.C.- ALM.PRF. 610 cm

YA-003

YA-001 C

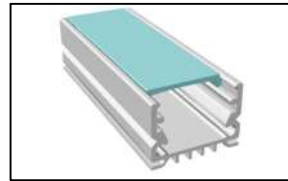

P.C.- ALM.PRF. 610 cm

YA-003

YA-001 E

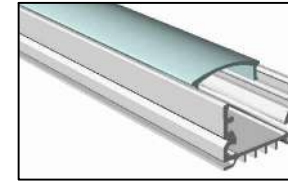

P.C.- ALM.PRF. 610 cm

YA-003

YA-001 F

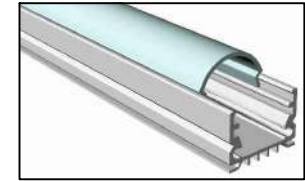

P.C.- ALM.PRF. 610 cm

YA-001 A3

Yük.Köş.Alm.Tapa

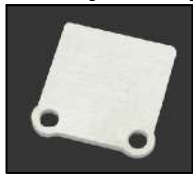

LAZER

YA 001 A PC.

YA-001 C 1

Pls. Kenar Tapa



RENK ; Açık Gri

YA-001 E 1

Düşük Bom.Pls. tapa



RENK ; Açık Gri

YA-001 F 1

Orta Bombeli Pls. tapa



RENK ; Açık Gri

MONTAJ 2/1

YA-001 C

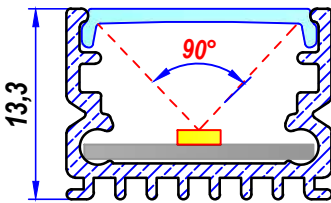

**Soğutma Kapasitesi yüksek
16 mm lik PCB uygun, ürün**

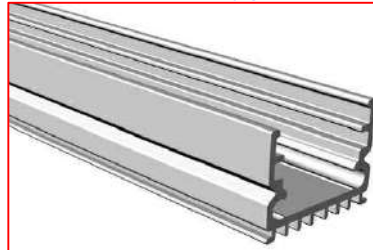

YA-003

ALM.PRF.610 cm

YA-003 A

Kenar Tapa-PC



Şeffaf

YA-001 E cama uygun

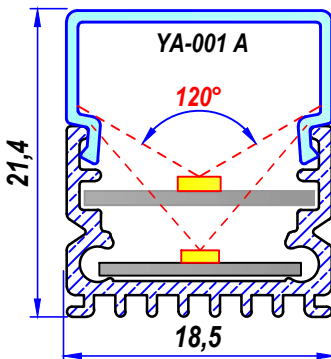

MONTAJ 2/1

YA-001 E

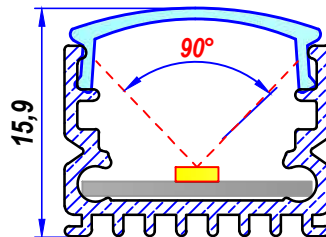

YA-003

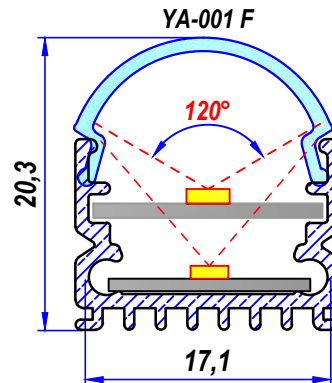

İstenilen ölçülerde kesim yapılır - İstenilen renge boyanır

All cutting dimensions and surface coatings can be done according to requirements

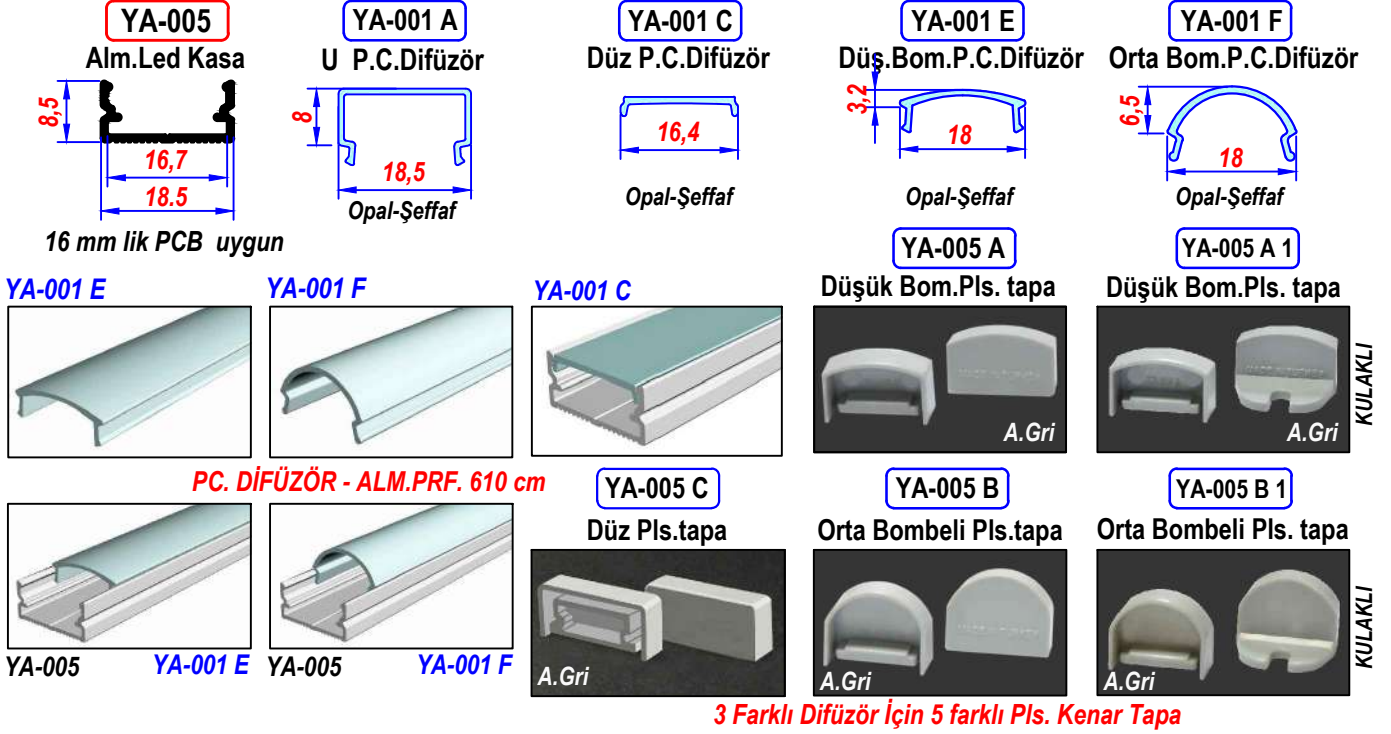

YA-001 E PC. DİFÜZÖR UYGULAMA



YA-001 F PC. DİFÜZÖR UYGULAMA



YA-001 E ve YA 001 F, YA-001 C PC.Difüzörlere uygun, 5 Farklı Kenar Tapa

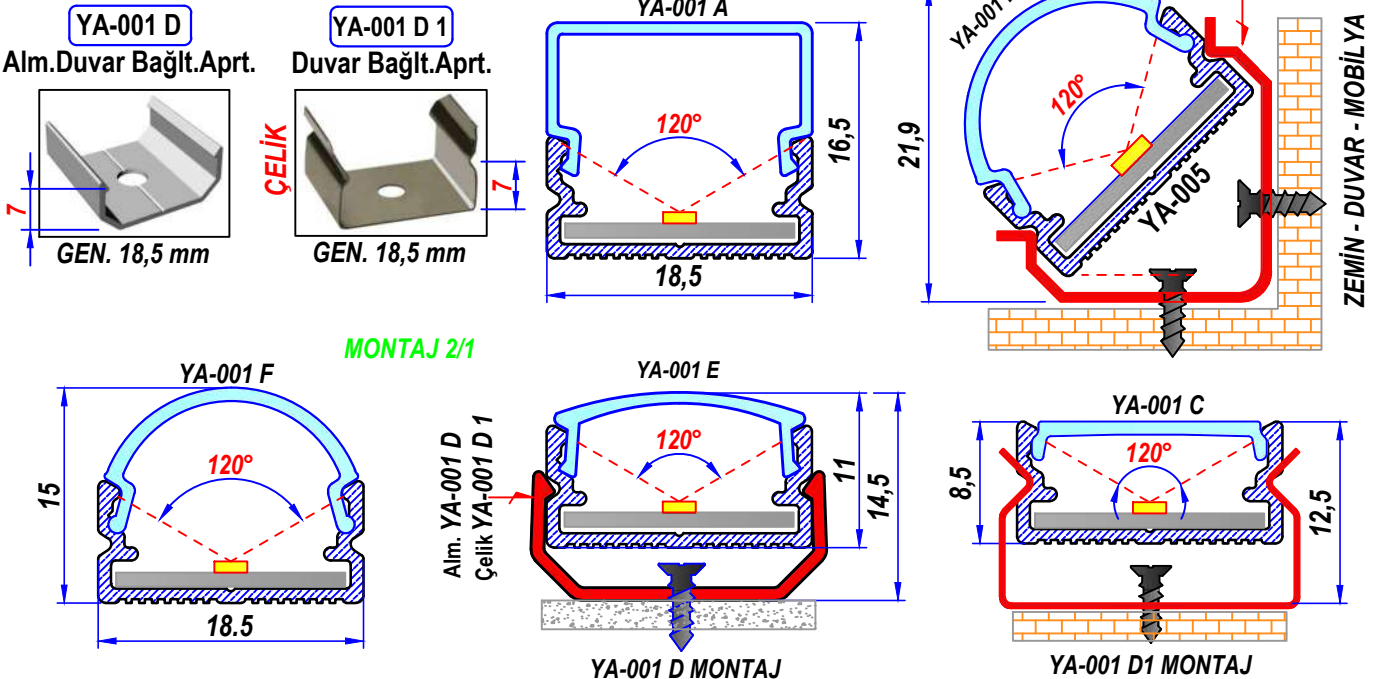

İstenilen ölçülerde kesim yapılır - İstenilen renge boyanır

IP 65 YA-006

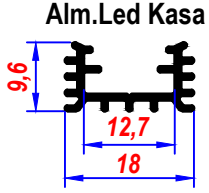

Led yuvası 12,7 mm
Dış mekan uygulamalara uygun,
Soğutma kapasitesi yüksek,
IP 65 ürün

YA-006 A

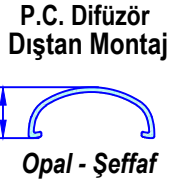

YA-006 B



YA-006 C



YA-001 D



YA 006



YA 006

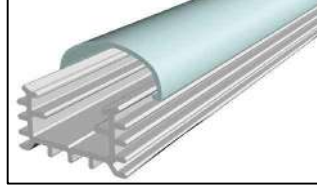

YA-006 A

PC.DİFÜZÖR - ALM.PRF. 610 cm

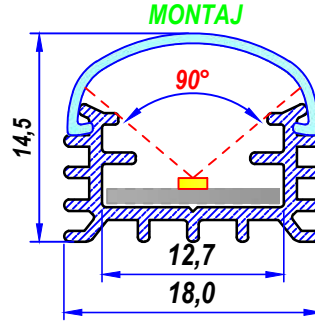

YA-001 D 1



IP 65 YA-007

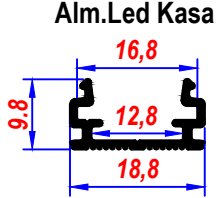

Led yuvası 12 ve 16 mm
Dış mekan, uygulamalara uygun
Soğutma kapasitesi yüksek,
IP 65 ürün

YA-006 A

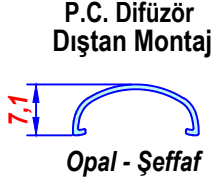

YA-007 A



YA-007 B



YA-001 D



YA 007



YA 007

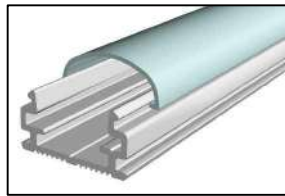

YA-006 A

PC.DİFÜZÖR - ALM.PRF. 610 cm

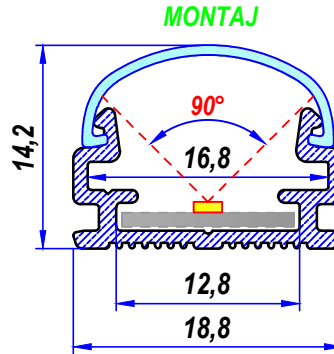

KULLANIM ALANLARI

Mobilya, Mutfak, Zemin, Duvar vb.
12-16 mm lik PCB ye uygun
Sıva Üstü, IP 66 Led Profili

YA-008

Alm.Led Kasa

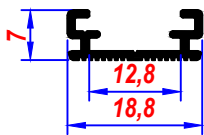

Alt yuva, 12 mm lik PCB ye
Üst yuva, 16 mm lik PCB ye uygun

YA 008

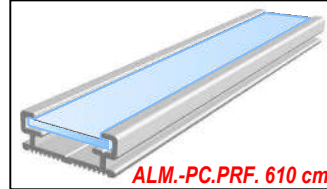

ALM.-PC.PRF. 610 cm

KULLANIM ALNALARI

Mobilya, Mutfak, Zemin, Duvar vb.
12-16 mm lik PCB ye uygun
Dekoratif Sıva Üstü Led Profili

YA 008 C

YA-001 D

Alm.Duvar Bağlt.Aprt.

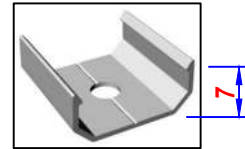

YA-008 C

P.C. Difüzör

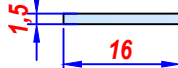

Sürülebilir düz difüzör

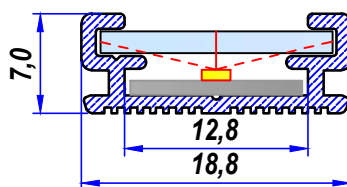

MONTAJ

YA-001 D 1

Duvar Bağlt. Aprt.



İÇ MEKAN, KABLO KANALI PROFİL VE AKSESUARLARI

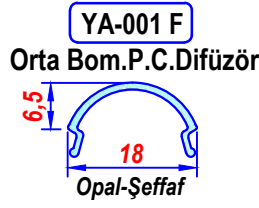
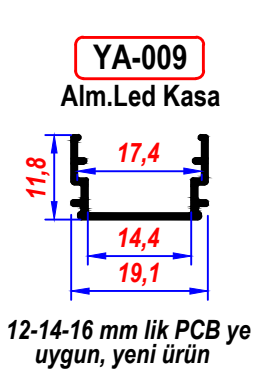

Birbirine takılarak, kablo kanalı ve duvar bağlantı aparatı gibi de kullanıma uygun, ÜRÜN

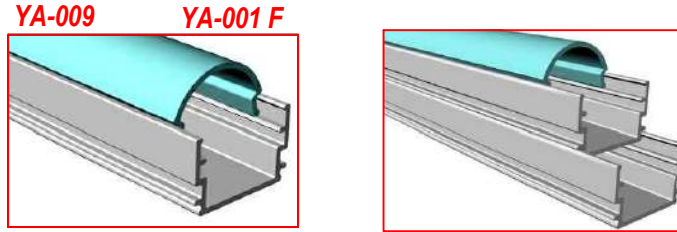

ALM. ve PC.DİFÜZÖR 610 cm

Detay; sayfa 7 de

YENİ DIŞ MEKAN, IP 66 ALÜMİNYUM PROFİL VE AKSESUARLARI

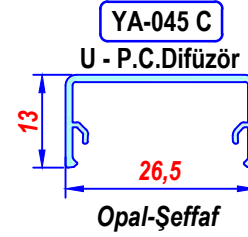
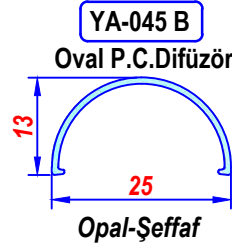
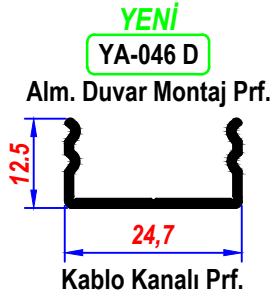
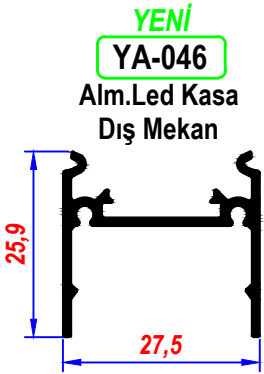

Detay; sayfa 18 de

DIŞ MEKAN, IP 66 ALÜMİNYUM PROFİL VE AKSESUARLARI

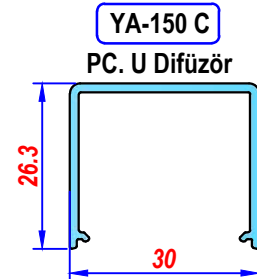
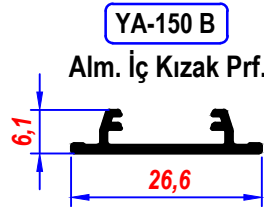
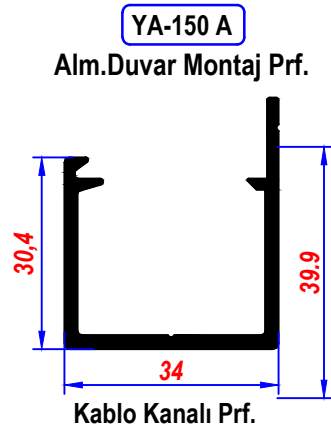
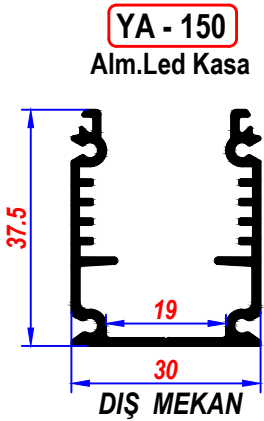

Detay; sayfa 53 de

YA-009

Alm.Led Kasa

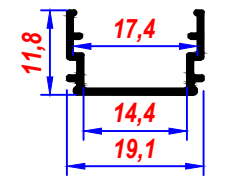

12-14-16 mm lik PCB ye uygun, yeni ürün

YA-001 F

Orta Bom.P.C.Difüzör

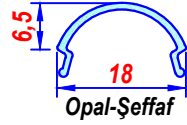

Dört farklı difüzör

YA-009 T

Pls.Kenar Tapa



YA-001 F difüzöre uygun

MONTAJ 2/1

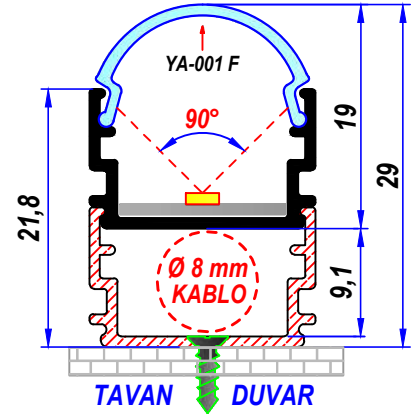

Birbirine takılarak, kablo kanalı ve duvar bağlantı aparatı gibi de kullanıma uygun, ÜRÜN

YA-001 C

Düz P.C.Difüzör



YA-001 E

Düş.Bom.P.C.Difüzör



YA-001 A

U P.C.Difüzör

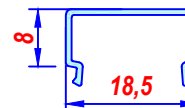

YA-009

YA-001 F

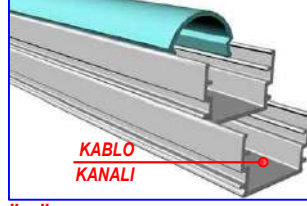
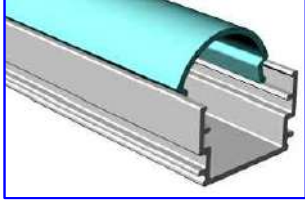

ALM. ve PC.DİFÜZÖR 610 cm

DÖRT FARKLI DİFÜZÖRE UYGUN ÜRÜN

YA-010

Alm.Led Kasa

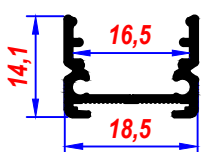

16 mm lik PCB ye uygun

Mıknatis Uygulama Profili

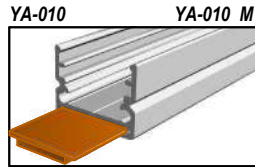

YA-010 M

Mıknatis Profili

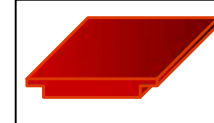
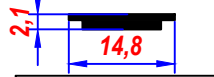

MIKNATIS PRF. 610 cm

Duvar bağlantı aparatı gerekmeden, sıkı geçme mıknatis profille birlikte, metal yüzeylere kolay montaj. Kullanım alanları; Mobilya, Mutfak, Zemin, Duvar, vb.

YA-001 A

U P.C.Difüzör



PC.DİFÜZÖR-ALM.PRF. 610 cm

OPAL - ŞEFFAF

YA-001 C

Düz P.C.Difüzör

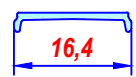

YA-001 E

Düş.Bom.P.C.Difüzör

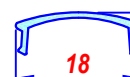

YA-001 F

Orta Bom.P.C.Difüzör

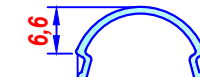

YA 010 Alm.Prf. ve AKSESUARLARI

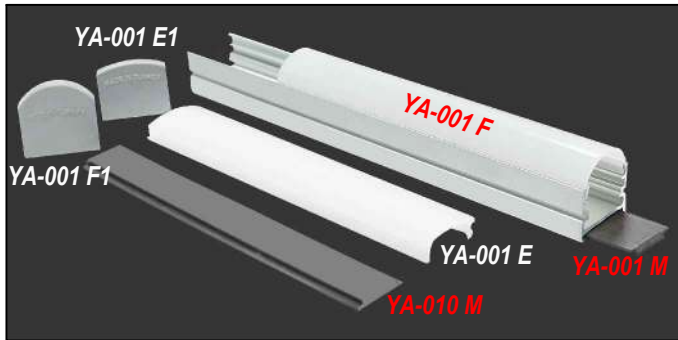

YA-001 E 1

Düşük Bom.Pls. tapa



YA-001 F 1

Orta Bomb. Pls. tapa



YA-001 C 1

Pls. Kenar Tapa



YA-001 A3

Alm. Kenar Tapa



YA 001 A PC.ye uygun

YA-001 A

MONTAJ

YA-001 F

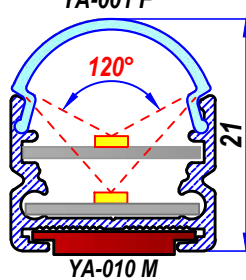
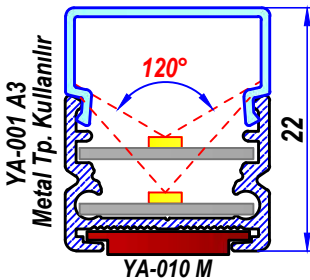

YA-001 E

MONTAJ

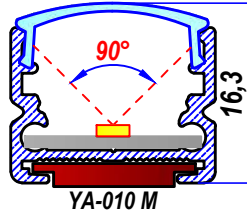

YA-001 C

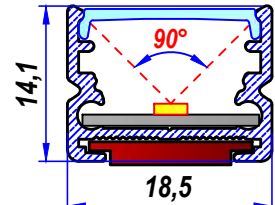

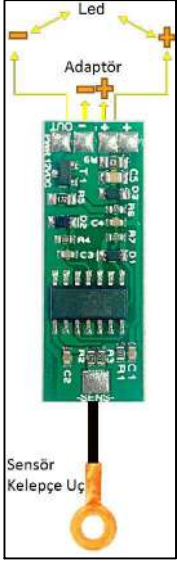

YA-004 D Dokunmatik Sensör

Çalışma aralığı ; 12 volt - 3 Amper

Güç ; 36 W

Ebat ; 40 x 13 mm

Maks. sensör kablo uzunluğu ; 3 mt

Ürünün kararlı çalışabilmesi için Yeni Model Adaptör (Switch Mode Power) ile kullanılması ve topraklama gerekir.

Sensör ucu kablosunun metal kasaya değmemesine dikkat ediniz.

YA-016, YA-019, YA-020, YA-1002 v.b profiller ile kullanıma uygundur



YA-004 H1 Dijital Hareket Sensörü

Çalışma aralığı ; 5-30 volt - 3 Amper

Yanma - sönmeye aralığı 30 sn, 1 dk, 2 dk

Algılama mesafesi; 5 mt

Çıkış Akımı 10 Ampere artırılabilir

Ebat ; 43 x 18,5 mm

YA-001 & YA-002 & YA-003 & YA-005, YA-006 & YA-007 & YA-010 & YA-016, ve daha büyük profillerle kullanıma uygundur

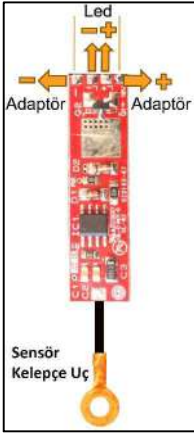

YA-004 D1 Kademeli Dokunmatik

Çalışma aralığı ; 12 V - 3 A

1.kademe; %33

2.kademe; %66

3.kademe; %100

4.kademe; %0

Ebat ; 41 x 11 mm

Güç ; 36 W

YA-016, YA-019, YA-020, YA-1002 v.b profiller ile kullanıma uygundur

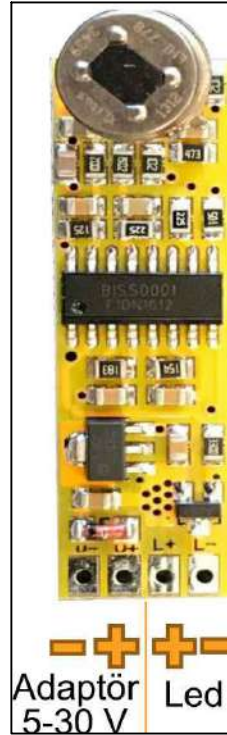

YA-004 H Hareket Sensörü

Çalışma aralığı; 5-30 volt - 4 Amper

Yanma - sönmeye aralığı; 5 sn - 5 dk

Algılama mesafesi; 3 mt

Ebat ; 40 x 11,5 x 15 (H) mm

YA-001 & YA-002 & YA-003 & YA-005, YA-006 & YA-007 & YA-010 & YA-016, ve büyük profillerle kullanıma uygun

Hareket algılayıcı göz, karttan maks. 20-25 cm uzaklığa kadar ayrı konumlanabilir Sönme süresi, son hareketi gördükten sonra başlar

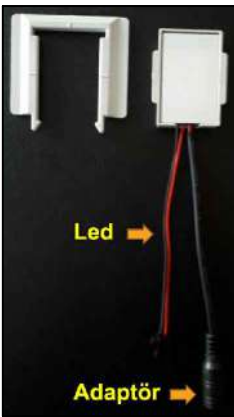
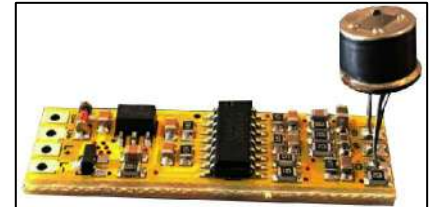

YA-004 D2 Ayna Dokunmatik

Çalışma aralığı ; 12-24 volt - 10 Amper

Algılama mesafesi; 1 cm

Ayna, cam gibi yerlerde kullanılır

Çıkış Akımı 20 Ampere artırılabilir

Sensör dokunmatiği çapı; 2-3 mm.

Mavi ışık sensörün kapalı olduğunu, Beyaz ışık sensörün açık olduğunu gösterir.

Ebat ; 46 x 30 mm

YA-016, YA-019, YA-020, YA-1002 v.b profiller ile kullanıma uygundur



YA-004 D21 Kademeli Ayna Dokunmatik

Özellikleri ayna dokunmatikle aynı. Parmak ucu dokunuşuyla ışık açılır.

Uzun dokunduğunuzda, kademe fonksiyonu aktifleşir

Işığın şiddeti kademeli ayarlanabilir

YA-004 D3 Led Sürücü Koruma Cihazı



Çalışma aralığı; 6-30 volt

Çıkış Akımı; 100mA - 1 A

Sürücü ile Led arasında yerleştirilir

Ebat ; 20 x 20 mm

Kutuların yanlış bağlanması durumunda, oluşabilecek sigorta arızalarını önler

AKSESUAR ALTERNATİFLİ, EKONOMİK LED BAR PROFİLİ

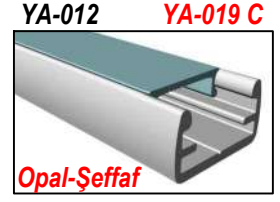
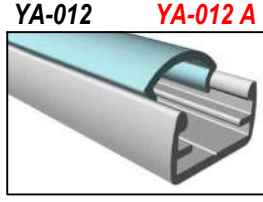
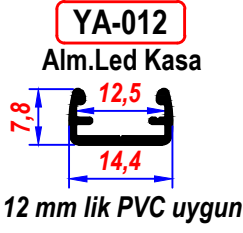

YA 012 ALM. LED KASA ve AKSESUARLARI

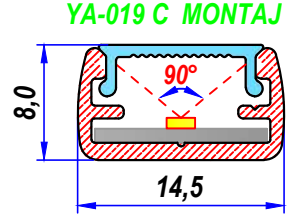
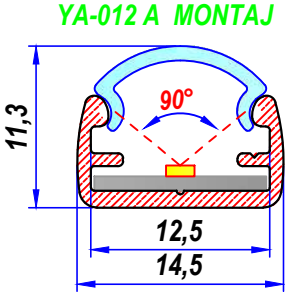

YA-004 D11 Yaylı Kademeli Dokunmatik

Giriş voltajı; 9V - 24V

Çıkış voltajı; 9V - 24V

Yük gücü; 30W

Yük akımı; 3A

Bekleme akımı; 10mA

Beklemede güç tüketimi; 0,1 w

Çalışma sıcaklığı; -20°C~65°C

Ebat ; 40 x 10 mm

Yayın geldiği yere parmakla bastırdığınızda, ışığın şiddeti kademeli artar veya azalır.

YA-016, YA-019, YA-020, YA-1002 v.b profiller ile kullanıma uygundur

YA-004 H3 Tek Kademeli IR Sensör

Çalışma aralığı ; 12 volt - 3 Amper, GÜÇ 36 W

Ebat ; 51 x 10 mm Algılama mesafesi ; 5 cm

Engel var ise ışık kapalı, Engel yok ise ışık açık

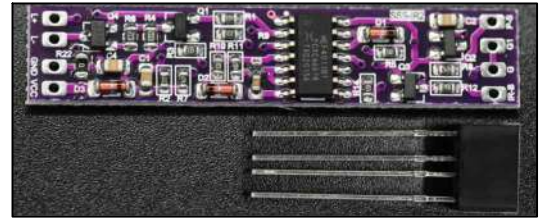

YA-004 H3 IR Hareket Sensör

Çalışma aralığı ; 12 volt - 3 Amper

Güç ; 36 W Ebat ; 51 x 10 mm

Algılama mesafesi ; 5 cm

Engel var ise ışık kapalı , Engel yok ise ışık açık

Unutulması veya elektrik kesintisinde 12 dk sonra kendisini kapatır

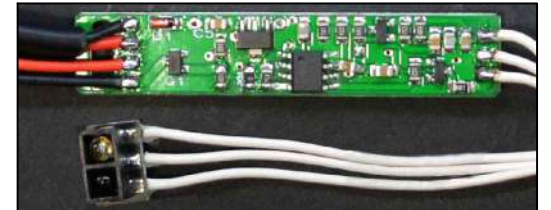

YENİ YA-004 H2 ON/OFF IR Sensör

Çalışma aralığı ; 12 volt - 3 Amper

Güç ; 36 W Ebat ; 51 x 10 mm

İlk hareketle açılır, ikinci hareketle kapanır



BUZDOLABI - SOĞUK HAVA DEPOLARI, HAVUZ VE ISLAK ORTAMLAR

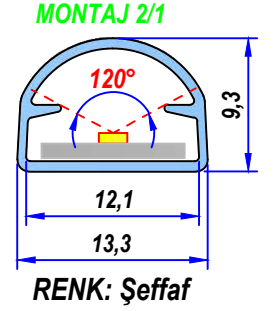
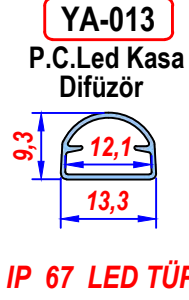

EKONOMİK LED BAR PROFİLİ

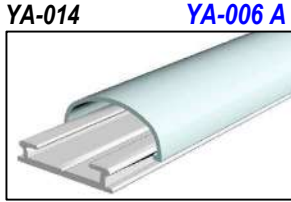
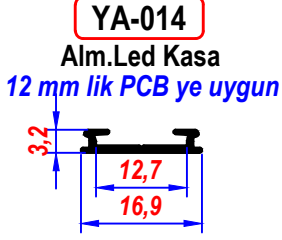

PC.DİFÜZÖR - ALM.PRF. 610 cm

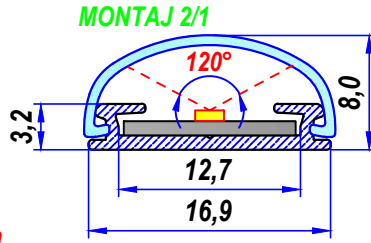
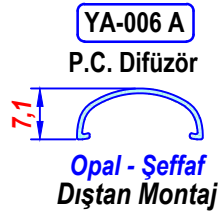

KULLANIM ALANLARI
Mobilya,Mutfak, Zemin, Duvar
Gergi Tavan & Barisol
Gizli tavan aydınlatma (Havuz)
Ekonomik Led Profili

EKONOMİK LED BAR PROFİLİ

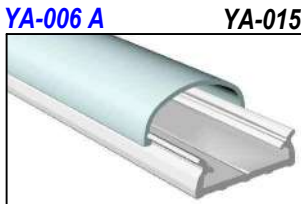
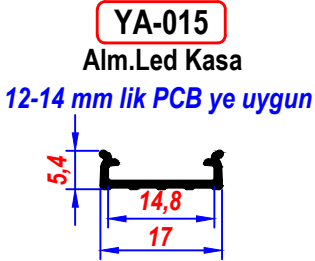

PC.DİFÜZÖR - ALM.PRF. 610 cm

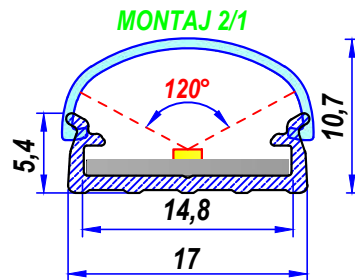
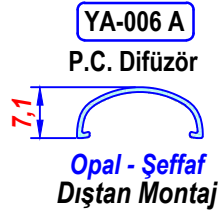

KULLANIM ALANLARI
Mobilya,Mutfak, Zemin, Duvar
Gergi Tavan & Barisol
Gizli tavan aydınlatma (Havuz)
Ekonomik Led Profili

GERGİ TAVAN PROFİLİ

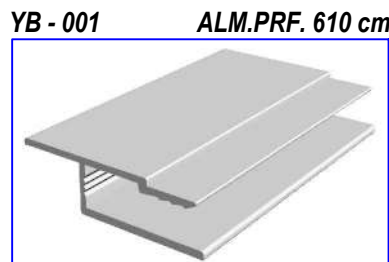
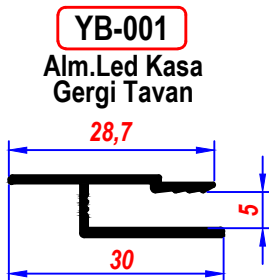

Gergi Tavan & Barisol prf.

GERGİ TAVAN UYGULAMASI

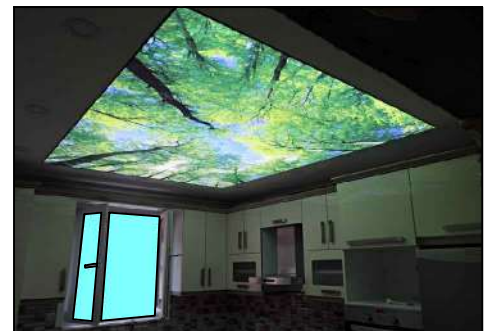

İstenilen ölçülerde kesim yapılır - İstenilen renge boyanır
All cutting dimensions and surface coatings can be done according to requirements

KÜÇÜK (8,5x13 mm) EKONOMİK, SIVA ÜSTÜ ALM. LED PROFİL VE AKSESUARLARI

YA - 019

Alm.Led Kasa

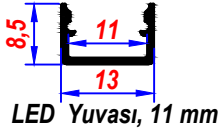

LED Yuvası, 11 mm

ÇOK SATAN ÜRÜN, YA-019



ALM.PRF. 610 cm

YA-012 D

Duv.Bğlt.Aprt.



ÇELİK

KULLANIM ALANLARI

Avize-Mobilya (Dolap ve çekmece içi),
Seramik-Duvar-Zemin-Merdiven-Ahşap gibi,
yüzelerde, sıfır veya siva üstü kullanıma uygun,
Dekoratif ve ekonomik minik, **siva üstü ÜRÜN**

YA-019

YA-019 C

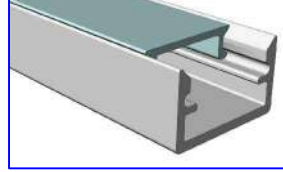

PC.DİFÜZÖR-ALM.PRF.610 cm

YA-019 C

PC.Cam-Difüzör



Opal,Şeffaf

Füme PC, çok yakında

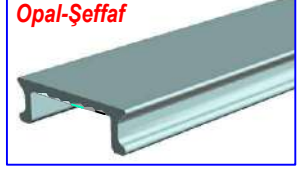

PC. Difüzör 610 cm

YA-019 T

Pls. Kenar Tapa



RENK ; A. Gri

MİNİK (10x10 mm) EKONOMİK, SIVA ÜSTÜ ALM. LED PROFİL VE AKSESUARLARI

YA - 032

Alm.Led Kasa

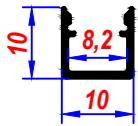

LED Yuvası, 8,2 mm

YA-032 **YA-032 C**

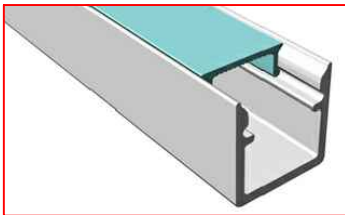

PC.DİFÜZÖR - ALM.PRF. 610 cm

YA-032 C

PC.Cam-Difüzör



Opal-Şeffaf

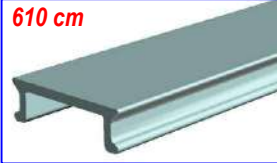

Füme Difüzör, çok yakında

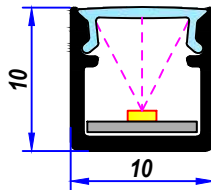

YA-032 T

Pls. Kenar Tapa

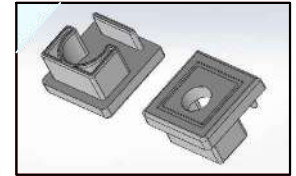

RENK ; Açık Gri

ÇEKMECE İÇİ AYDINLATMA



SÜPER MİNİ (6x8 mm) EKONOMİK, SIVA ÜSTÜ ALM. LED PROFİL VE AKSESUARLARI

YENİ YA - 041

Alm.Led Kasa

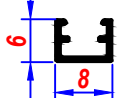

LED Yuvası, 6,4 mm

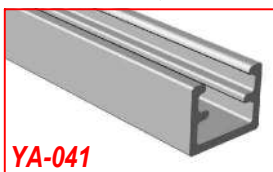

YA-041

SÜPER MİNİ EKONOMİK ÜRÜN

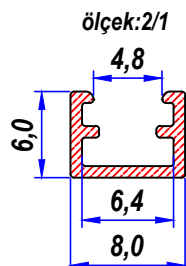

YA-041 C

PC.Cam-Difüzör

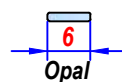

Opal

SÜRÜLEBİLİR DÜZ PC.

YA-041

YA-041 C

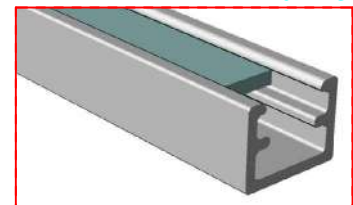

PC.DİFÜZÖR-ALM.PRF.610 cm

ISLAK ZEMİN - SERAMİK ALÜMİNYUM LED PROFİL VE AKSESUARLARI

YENİ YA-SR 15 IP 66

Alm. Seramik Led Kasa

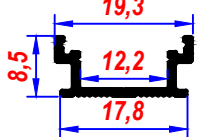

12 mm lik PCB ye uygun

YENİ YA-SR 15 C

P.C. Difüzör

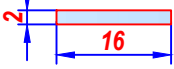

YA-SR 15

YA-SR 15 C

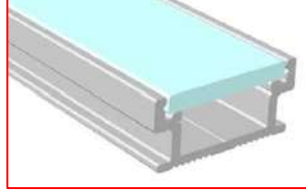

Alm. Prf.-P.C. Difüzör 610 cm

KULLANIM ALNALARARI

Mutfak, Banyo vb. ıslak Zeminler için,
IP 66 dekoratif Sıva Üstü Led Profili

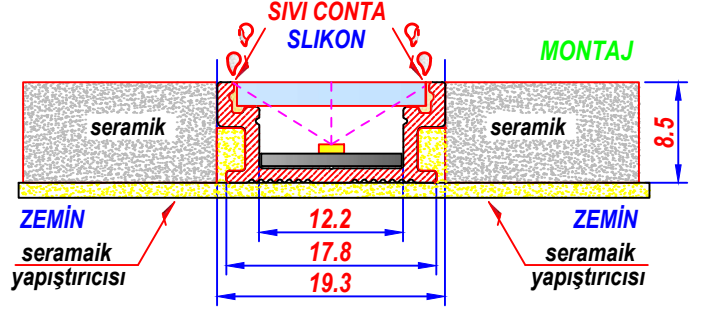

Üründe sızdırmazlık sağlayabilmek için,
kaliteli silikon kullanılması gerekmektedir.

YA-SR 01

Alm. Seramik Led Kasa

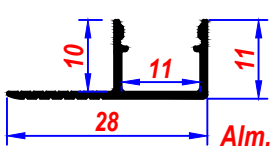

Alm. Prf.-P.C. Difüzör 610 cm

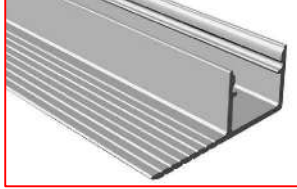

YA-019 C

PC.Cam-Difüzör



Opal, Şeffaf

Füme PC, çok yakında

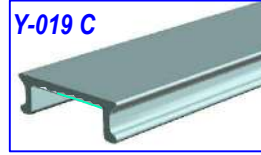

PC. Difüzör 610 cm

Mutfak, Banyo vb. ıslak Zeminler için,
Dekoratif Sıva Üstü Led Profili

MONTAJ 2/1

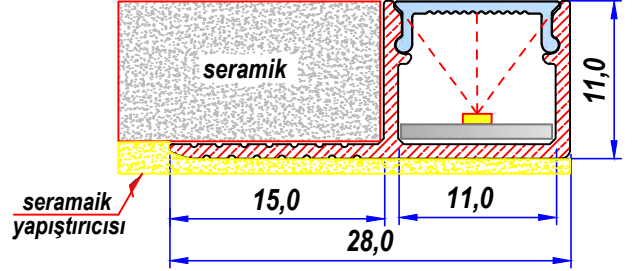

YA-SR 11

Alm. Seramik Led Kasa

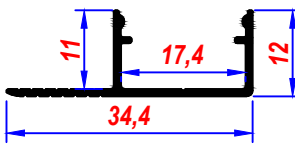

Alm. Prf. - P.C. Difüzör 610 cm

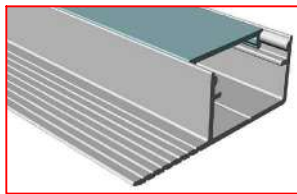

YA-1002 A

P.C. Difüzör

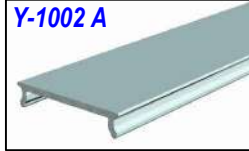
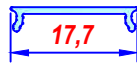

P.C. Difüzör 610 cm

Mutfak, Banyo vb. ıslak Zeminler için,
Dekoratif Sıva Üstü Led Profili

MONTAJ

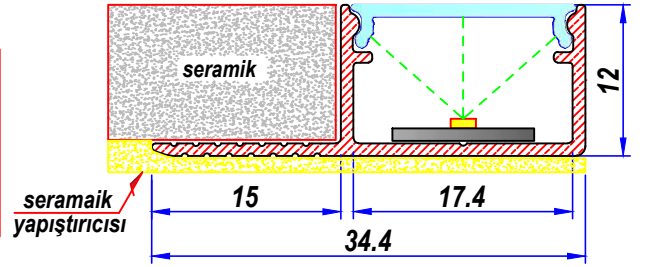

YA-SR 12

Alm. Seramik Led Kasa

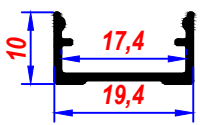

Alm. Prf. - P.C. Difüzör 610 cm

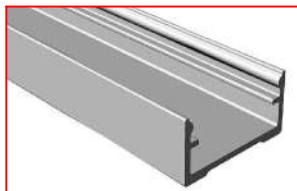

YA-1002 A

P.C. Difüzör



Y-1002 A

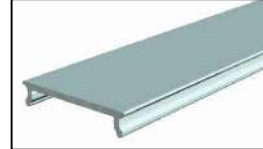

P.C. Difüzör 610 cm

Mutfak, Banyo vb. ıslak Zeminler için,
Dekoratif Sıva Üstü Led Profili

MONTAJ

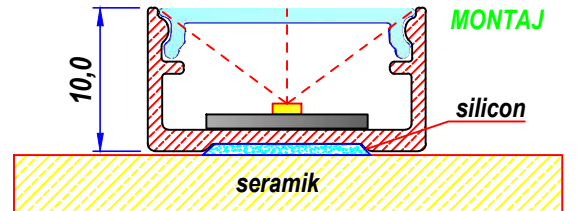

YENİ, İÇ MEKAN EKONOMİK LED ALÜMİNYUM PROFİL VE AKSESUARLARI

YENİ YA-026 Y

Alm. Led Prf.

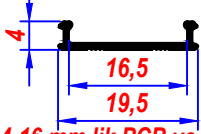

14-16 mm lik PCB ye uygun

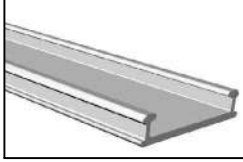

YA-026 ALM. PRF. 610 cm

YA-001 A

U P.C. Cam

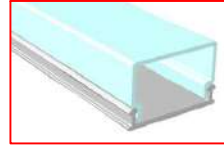
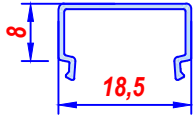

Top.Yük. H = 12 mm

YA-001 C

Düz PC. Cam

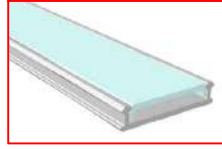
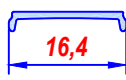

Top.Yük. H = 4.5 mm

YA-001 E

Düş.Bom.PC.Cam

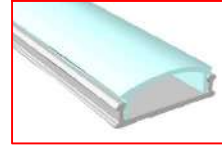
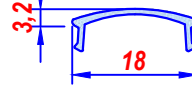

Top.Yük. H = 6.9 mm

YA-001 F

Orta Bom.PC.Cam

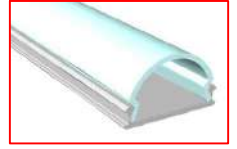
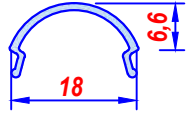

Top.Yük. H = 11 mm

PC. Difüzör - ALM. Profiller 610 cm - opal / şeffaf

YA-026 alm. profil, PC. difüzörle birlikte kullanıldığında, 14 mm lik PCB ye uygundur

DIŞ MEKAN, HORTUM - NEON LEDLERE UYGUN ALÜMİNYUM PROFİLLER

YA-018

Alm. Neon Led Kasa

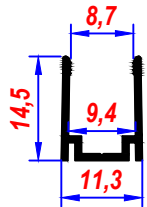

ALM.PRF. 610 cm

MONTAJ

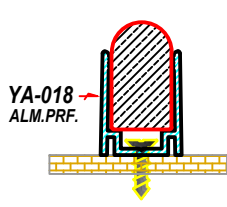

NEON LED

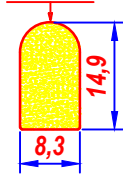

NEON LED KASASI-YA-018 / YA-035

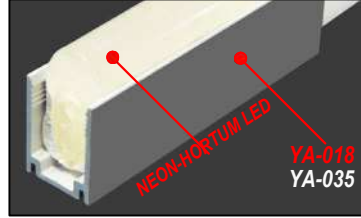

ZEMİN-DUVAR-MOBİLYA ya MONTAJ

YA-035

Alm. Neon Led Kasa

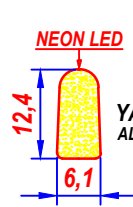

ALM.PRF. 610 cm

MONTAJ

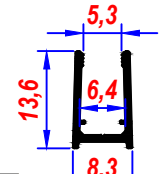
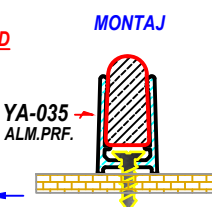

YENİ

YA-036

Alm. Neon Led Kasa

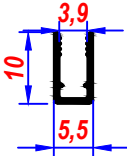

ALM.PRF. 610 cm

MONTAJ

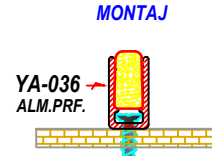

NEON LED

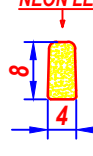

NEON LED KASASI YA-036 / YA-037

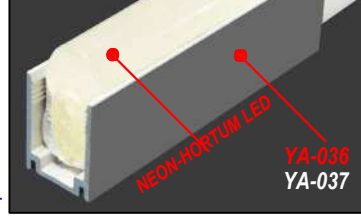

ZEMİN-DUVAR-MOBİLYA ya MONTAJ

NEON LED

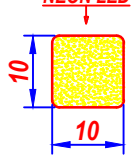

MONTAJ

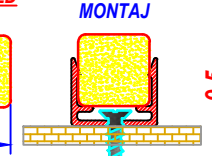

Alm. Neon Led Kasa

ALM.PRF. 610 cm

YENİ

YA-037

YENİ

YA-038

Alm. Neon Led Kasa

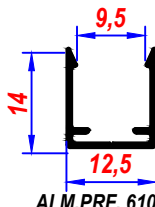

ALM.PRF. 610 cm

MONTAJ

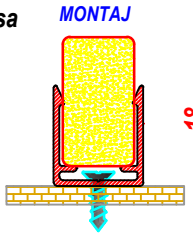

NEON LED

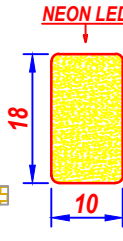

NEON LED KASASI YA-038 / YA-039

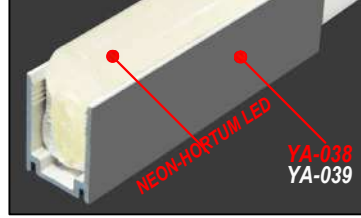

ZEMİN-DUVAR-MOBİLYA ya MONTAJ

NEON LED

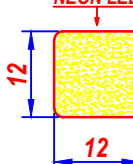

MONTAJ

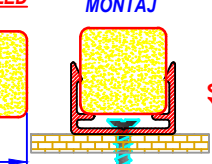

Alm. Neon Led Kasa

ALM.PRF. 610 cm

YENİ

YA-039

YENİ

YA-040

Alm. Neon Led Kasa

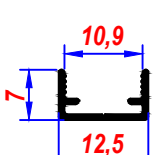

ALM.PRF. 610 cm

MONTAJ



NEON LED

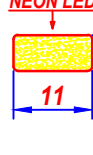

NEON LED KASASI YA-040

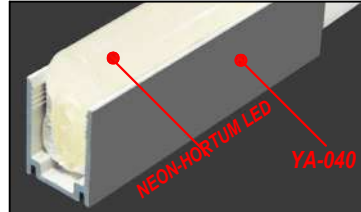

ZEMİN-DUVAR-MOBİLYA ya MONTAJ

FARKLI NEON LED KASALAR



İÇ MEKAN, TEK YÖNLÜ APLİK PROFİL VE AKSESUARLARI

MONTAJ 1/1

YA - 023

Alm.Led Kasa
19,5

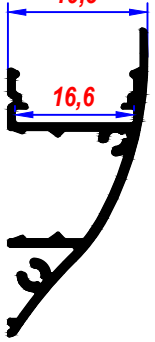

YA-023 B

Alm.Montaj Prf.

14,7

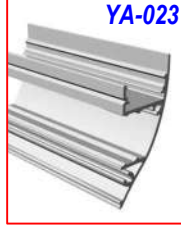

YA-001 E

Düş.Bom.P.C.Difüzör

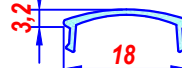

Opal-Şeffaf

YA-001 F

Orta Bom.P.C.Difüzör



Opal-Şeffaf

YA-023 ve AKSESUARI

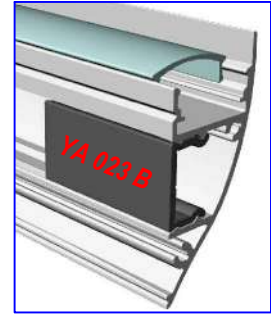

TEK YÖNLÜ AYDINLATMA

ALM. ve PC. PRF. 610 cm

Detay;sayfa 15 de

İÇ MEKAN, İKİ YÖNLÜ APLİK PROFİL VE AKSESUARLARI

YA - 024

Alm.Led Kasa

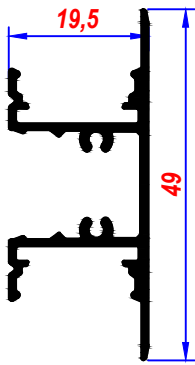

YA-023 B

Alm.Montaj Prf.

14,7

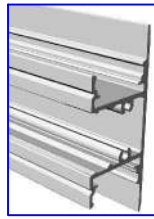

YA-001 E

Düş.Bom.P.C.Difüzör

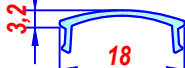

Opal-Şeffaf

YA-001 F

Orta Bom.P.C.Difüzör



Opal-Şeffaf

YA-024 ve AKSESUARI

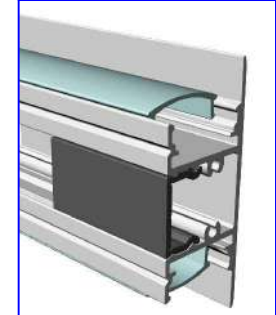

İKİ YÖNLÜ AYDINLATMA

ALM. ve PC. PRF. 610 cm

Detay;sayfa 15 de

YENİ

DIŞ MEKAN, İKİ YÖNLÜ APLİK PROFİL VE AKSESUARLARI

ALM. ve PC. PRF. 610 cm

YA - 227

Alm. Lineer Kasa

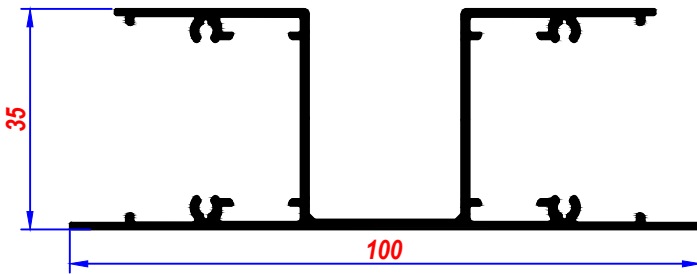

YA-G 35 C

PC.Cam-Difüzör

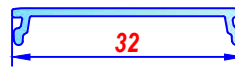

Kumlu Opal

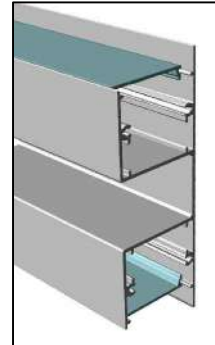

Detay;sayfa 76 da

YA - 225

Alm. Lineer Kasa
İki Noktadan Aydınlatma

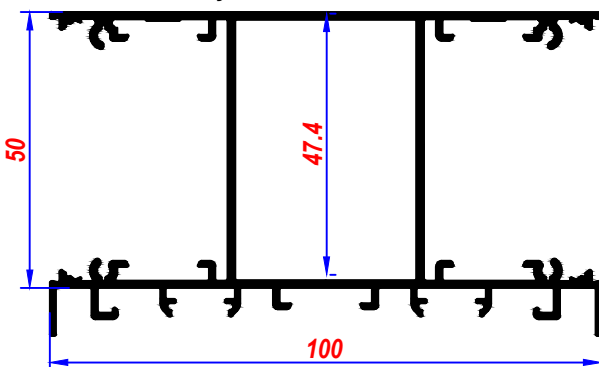

YA-G 50 A

PC.Cam-Difüzör



Kumlu Opal

YA-209 D

Alm. Prf. (Tavan Montaj)

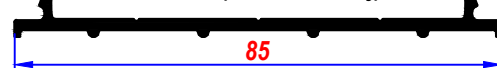

Alm.Profil 610 cm

Detay;sayfa 77 de

İÇ MEKAN, SIVA ÜSTÜ ALM. LED PROFİL VE AKSESUARLARI

YA - 023
Alm.Led Kasa

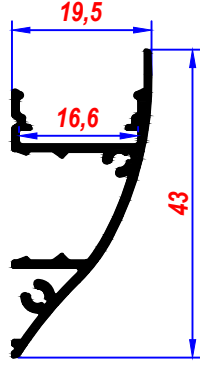

YA-023 B
Alm.Montaj Prf.

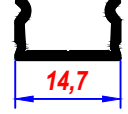

ALM. PRF. 610 cm

YA-001 A
U P.C.Difüzör

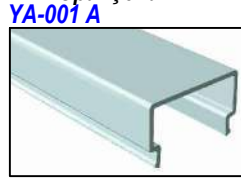
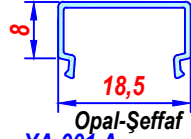

YA-001 E
Düş.Bom.P.C.Difüzör

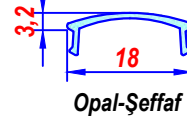

YA-001 F
Orta Bom.P.C.Difüzör

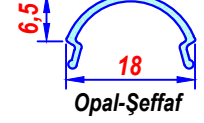

PC. DİFÜZÖR 610 cm

KULLANIM ALANLARI

Mobilya, Süpürgelik, Duvar, Bordür
Aplik vb, kullanıma uygun, dekoratif ürün

YA-023 T1
Alm. Kenar Tapa

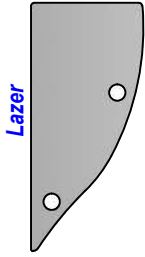

YA-023

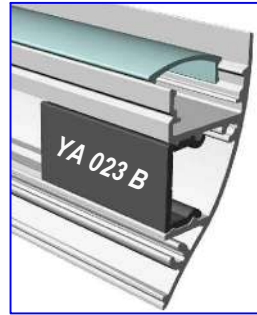

YA-023 ve AKSESUARI

MONTAJ 1/1

YA 001 E-YA-001 F

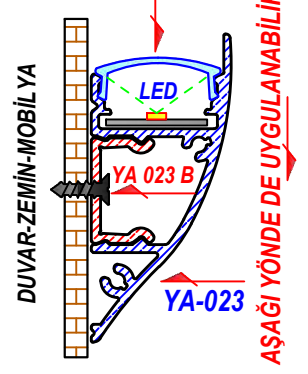

YA - 024
Alm.Led Kasa

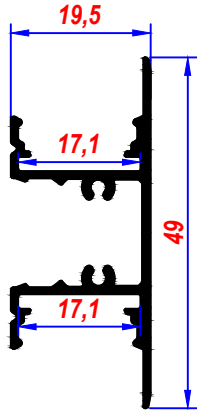

YA-023 B
Alm.Montaj Prf.

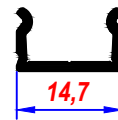

ALM.PRF. 610 cm

YA-001 A
U P.C.Difüzör

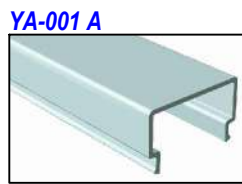
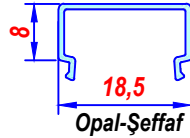

YA-001 E
Düş.Bom.P.C.Difüzör

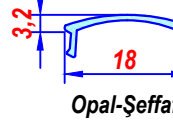

YA-001 F
Orta Bom.P.C.Difüzör

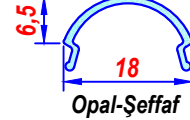

PC. DİFÜZÖRLER 610 cm

KULLANIM ALANLARI

Mobilya, Süpürgelik, Duvar, Bordür
İki yönlü Aplik vb, kullanıma uygun ürün

YA-024 T1
Alm. Kenar Tapa

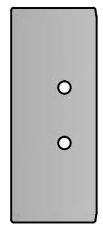

Lazer Tapa



ALM. ve PC. prf. 610 cm

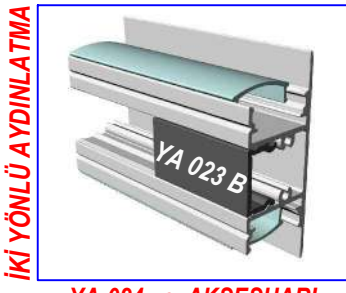

YA-024 ve AKSESUARI

MONTAJ

YA 001 E

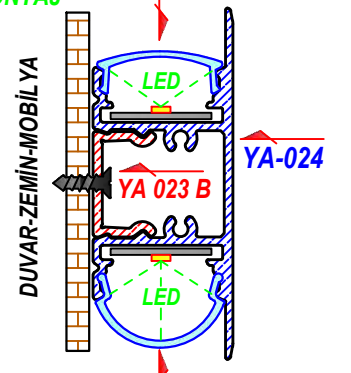

YA 001 F

İstenilen ölçülerde kesim yapılır - İstenilen renge boyanır

All cutting dimensions and surface coatings can be done according to requirements

İÇ MEKAN DEKORATİF ÜRÜN (MERDİVEN ALTI)

YA-017

Alm.Led Kasa

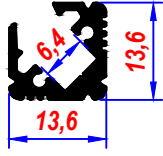

18 mm SUNTA UYGULAMASI

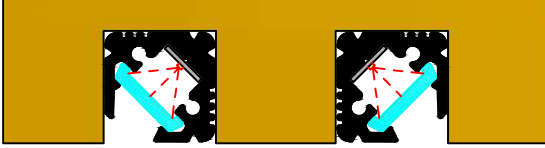

PSB aralığı : 6,4 mm

YA-017 A

P.C. Difüzör



YA-017 B

Alm.Lazer Tapa



YA-017 Alm.Prf.ve PC difüzör



PC.DİFÜZÖR-ALM.PRF. 610 cm



MERDİVEN UYGULAMASI

İÇ MEKAN, DEKORATİF-KÜÇÜK SIVA ÜSTÜ ALM. PROFİL VE AKSESUARLARI

YA-023 B

Alm.Led Kasa
(Montaj Prf.)

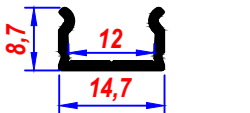

YA-023 B YA-012 A

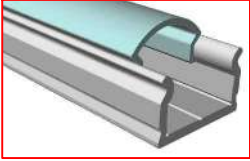

YA-012 A

P.C. Difüzör



YA-023 B YA-019 C

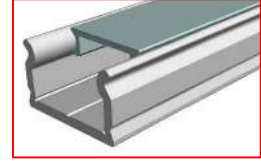

YA-019 C

P.C. Difüzör



Füme PC.Çok yakında

YA-019 T

Pls. Kenar Tapa



YA-019 C PC.ye uygun

YA-012 D

Duv.Bğlt.Aprt.



ÇELİK

YA-023 B ALM. LED KASA ve AKSESUARLARI

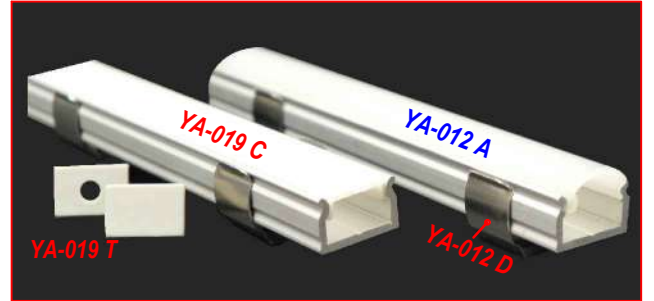

ALM.PRF. ve PC.DİFÜZÖR 610 cm

YA-023 B Duvar Bağlantı Profili, 2 farklı PC.ve çelik klipsle, ayrı küçük çizgisel aydınlatmaya uygundur

KULLANIM ALANLARI

Mobilya-Duvar-Zemin-Merdiven-ahşap gibi yüzelerde kullanıma uygun, dekoratif ve ekonomik minik siva üstü ÜRÜN

ŞERİT LED İÇİN ALÜMİNYUM (LAMA) LED PROFİLLER

Şerit led yapıştırılarak kullanılan, 10-12-15 ve 16 mm lik Alüminyum profiller

YA - 025

Alm.Led Prf.

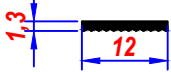

12 mm lik Alm.Prf.



YA-025 ALM. PRF. 610 cm

YA-025 A

Alm.Led Prf.

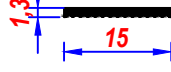

15 mm lik Alm.Prf.

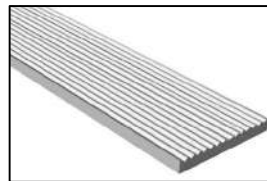

YA-025 A ALM. PRF. 610 cm

YA-025 B

Alm.Led Prf.

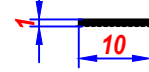

10 mm lik Alm.Prf.

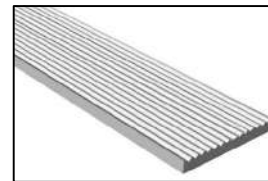

YA-025 B ALM. PRF. 610 cm

İstenilen ölçülerde kesim yapılır - İstenilen renge boyanır

All cutting dimensions and surface coatings can be done according to requirements

IP 66 YA UYGUN 2 ÇEŞİT PC CAM SEÇENEĞİ

YA-045

Alm.Led Kasa
Dış Mekan

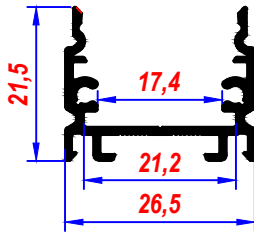

IP 65 Uygun, İç-Dış Mekan Ürün
NEON Led, Modül led ve
3 cipli şerit ledlere uygun

YA-045 A

Düz P.C.Difüzör

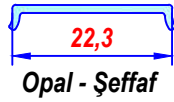

YA-045 B

Oval P.C.Difüzör



YA-045 C

U - P.C.Difüzör



YA-045 D

Duvar Bağlt. Aprt.



ÇELİK

Üç farklı P.C. difüzör, seçeneği
IP 65 uygun PC cam, seçenekleri
Gerektiğinde Sarkıt olarak da
kullanıma uygun ürün

YA-045 E

Pls. Kenar Tapa



YA-045 A Difüzöre uygun

YA-045 F

Pls. Kenar Tapa



YA-045 C Difüzöre uygun

YA-045 G

Pls. Kenar Tapa



YA-045 B Difüzöre uygun

YA 045 A - YA 045 C PC DİFÜZÖR UYGULAMA

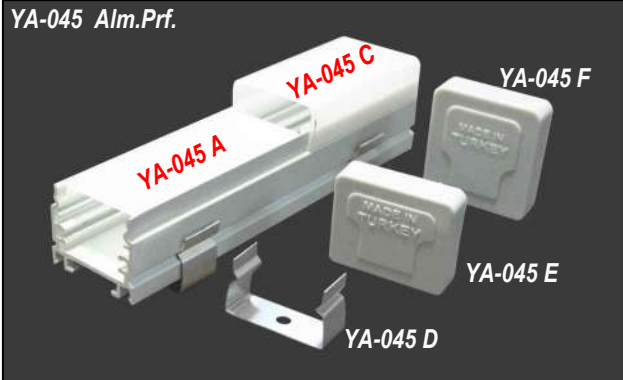

YA 045 B PC DİFÜZÖR UYGULAMA

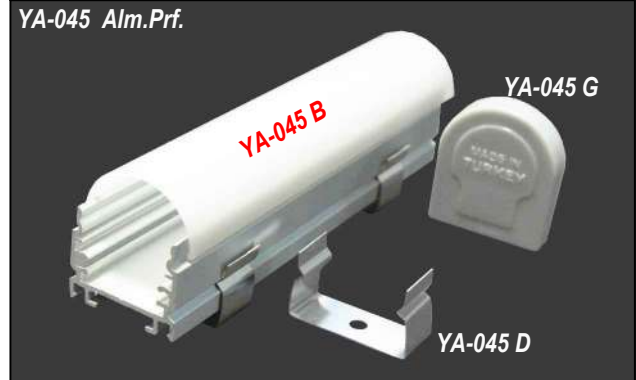

YA-045 Alm.prf.



PC.DİFÜZÖR-ALM.PRF. 610 cm

YA-045 YA-045 A

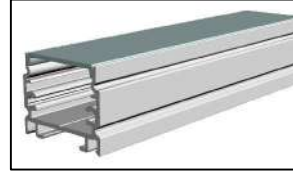

YA-045 YA-045 B

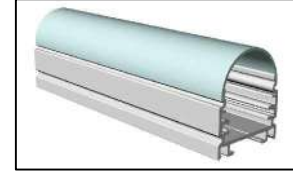

PC.DİFÜZÖR-ALM.PRF. 610 cm

YA-045 YA-045 C

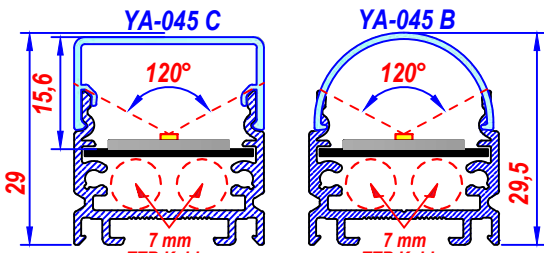
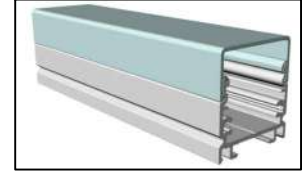

İç kızak profili kullanılarak, iç-dış mekanda
Kesintisiz uygulama

MONTAJ

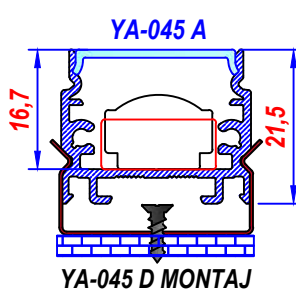

YA-045 D MONTAJ

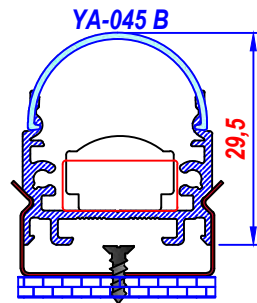

YA-045 D MONTAJ

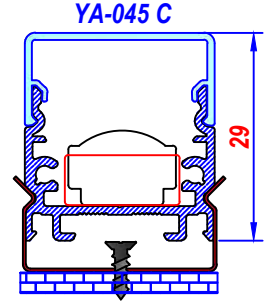

YA-045 D MONTAJ

DIŞ CEPHE, MİMARİ LED AYDINLATMA PROFİL VE AKSESUARLARI

YENİ
IP 66 YA-046
Alm.Led Kasa
Dış Mekan

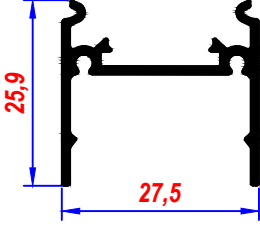

IP 66 ya UYGUN, DIŞ MEKAN

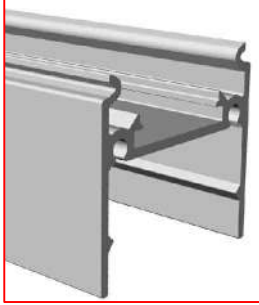

ALM. PRF. 610 cm

YENİ
YA-046 D
Alm. Duvar Bağlt.Prf.
Kablo Kanalı Prf.

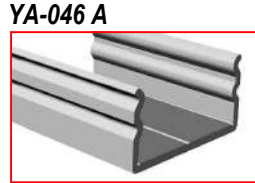
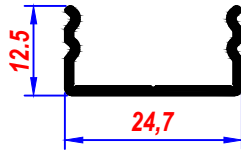

ALM. PROFİL 610 cm

YA-045 B
Oval P.C.Difüzör
Opal-Şeffaf

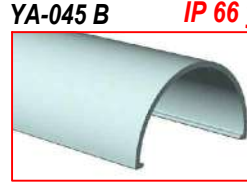
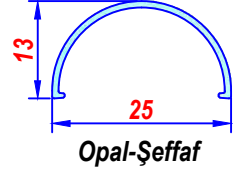

PC Difüzör 610 cm

YA-045 C
U - P.C.Difüzör
Opal-Şeffaf

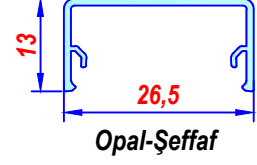

YA-207 D

Tavan Askı Aparatı
Tekli-Krom - 1,5 mt



özel tel ölçüsü sipariş edilebilir

NEON Led, Modül led ve
3 cipli şerit ledlere uygun ürün
IP 66 ya uygun, iki farklı P.C. difüzör,
iki kademeli Alm.Duvar bağlantı profili,
Gerektiğinde Sarkıt olarak da
kullanıma uygun, yeni dış mekan ürün

YA-046 D Alm.Profili, kablo kanalı ve Duvar
montaj profili gibi, boy veya parçalar
halinde kullanılabilir

YA-046 E
Alm.Ken.Tapa

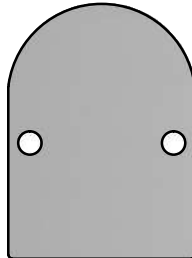

Kalınlık 1.5 mm

YA-046 F
Alm.Ken.Tapa

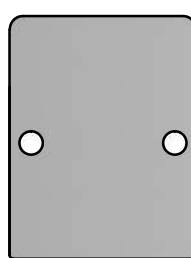

Kalınlık 1.5 mm

YA-046 T
PLS. Ken.Tapa



YA-045 B DIFÜZÖRE UYGUN

ÇOK YAKINDA

YA-046 YA-045 B PC.

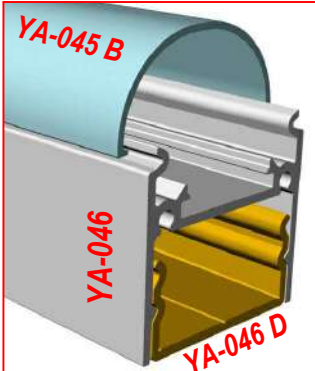

ALM.PC.PRF. 610 cm

BİNA DIŞ CEPHE UYGULAMASI



İstenilen ölçülerde kesim yapılır - İstenilen renge boyanır

YA-046 YA-045 C PC.

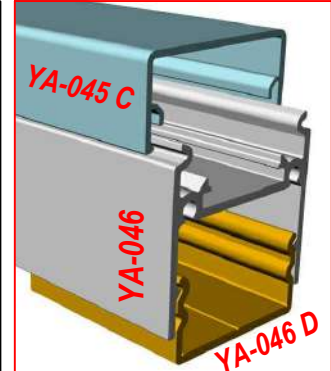

ALM.PC.PRF. 610 cm

İÇ MEKAN, SIVA ÜSTÜ LED PROFİL VE AKSESUARLARI

YA-034

Alm. Led Kasa

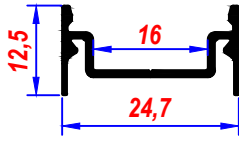

YA-034



KULLANIM ALANLARI

Mobilya-Duvar-Zemin-Merdiven-aşşap gibi yüzelerde kullanıma, uygun, dekoratif ve ekonomik siva üstü yeni ÜRÜN

Ürüne uygun kenar tapa, çok yakında

YA-045 A

Düz P.C.Difüzör



Opal - Şeffaf

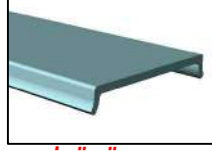

PC.DİFÜZÖR 610 cm

YA-034

YA-045 A

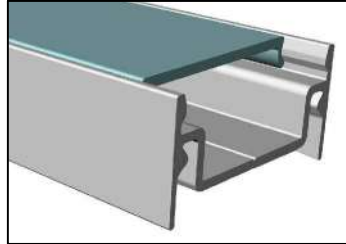

PC.DİFÜZÖR-ALM.PROF. 610 cm

YA-034 D

Duvar Bağlt. Aprt.

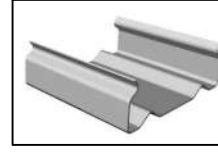

Çok Yakında

ÇELİK

MONTAJ 2/1

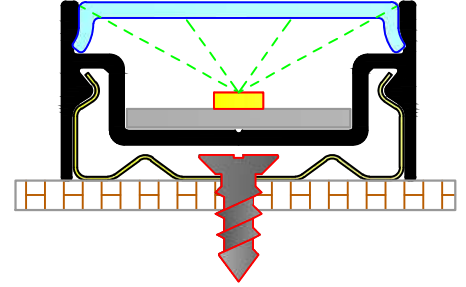

DUVAR-ZEMİN-MOBİLYA

DIŞ MEKAN, SIVA ALTI - GÖMME ALM. LED PROFİL VE AKSESUARLARI

YA - 022

Alm.Led Kasa

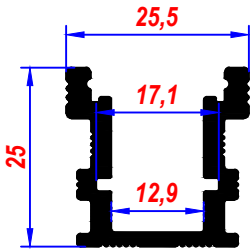

12 mm lik PCB ye uygun

YA-022

ALM.PROF. 610 cm

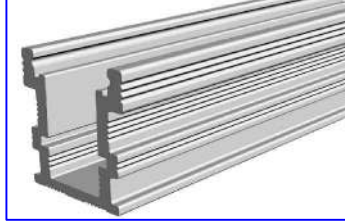

YA-022 C

P.C.Cam-Difüzör

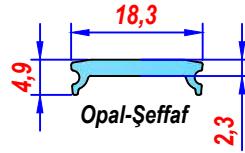

Opal-Şeffaf

YA-022 T

Pls. Kenar Tapa



RENK : A.GRİ

Ürün, standart yüklere karşı dayanıklıdır. Üründe, sonlandırma tapaları ve PC. Difüzörün sızdırmazlık sağlaması için, mutlaka kaliteli şeffaf silikon kullanılması gerekmektedir

YÜRÜYÜŞ YOLU-OTOPARK - OTO YOLU VB

MONTAJ

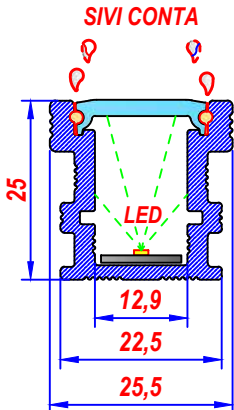

BORDÜR TAŞI, UYGULAMA ŞEKLİ



BORDÜR ZEMİNDE, DÜZ VE EĞİMLİ UYGULAMA



İstenilen ölçülerde kesim yapılır - İstenilen renge boyanır
All cutting dimensions and surface coatings can be done according to requirements

EKONOMİK SIVA ALTI (GÖMME) - SIVA ÜSTÜ PLASTİK LED AYDINLATMA PROFİLLERİ

YENİ YP - 001

Pls.Gömme Led Prf.

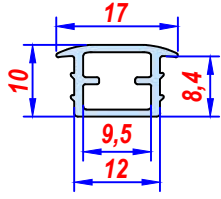

IP 66 MONTAJ

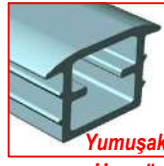

Yumuşak
18 mm Sunta Uygulaması
Her yöne esneyebilen,
Yumuşak ve bükülebilir ürün
100 mt RULO - RENK OPAL

KULLANIM ALANLARI

Mobilya, Dolap, Çekmece içi, Seramik, duvar, zemin, merdiven ve ahşap gibi yerlerde, kullanıma uygundur. Ekonomik olan bu ürün, yumuşak nitelikte olup siva altına uygun olarak üretilmiştir
IP 66 kullanıma uygun,

YENİ

YP - 002

Yumuşak
Led Prf.
IP 66

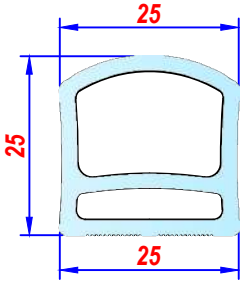

Her yöne esneyebilen,
Yumuşak ve bükülebilir ürün

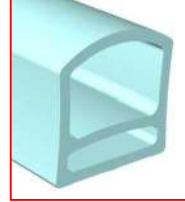

100 mt RULO - renk OPAL

KULLANIM ALANLARI

İç ve dış mekan IP 66 YENİ ürün. Duvar ve zemin gibi yerlerde, kullanıma uygundur. Ekonomik olan bu ürün, yumuşak nitelikte olup, siva üstüne uygun olarak üretilmiştir

GP-001 P

Pls.Gömme Led Prf.
Kulaklı-Açık

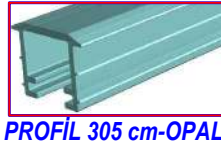
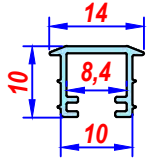

PROFİL 305 cm-OPAL



18 mm Sunta Uygulaması

YENİ

GP-001 K

Pls.Gömme Led Prf.
Kulaklı-Açık

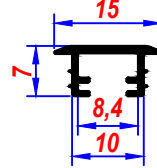

PROFİL 305 cm-OPAL



18 mm sunta ve siva üstü panellere uygun

GP-002 P

Pls.Gömme Led Prf.
Kulaklı-Açık

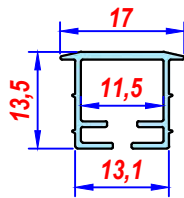

PROFİL 305 cm-OPAL

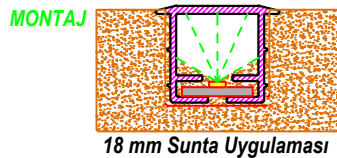

18 mm Sunta Uygulaması

GP-030

Plastik Led Prf.(Açık)

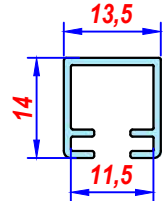

PROFİL 305 cm-OPAL



18 mm Sunta Uygulaması

GP-020

Pls.Gömme Led Prf.
Kulaklı - Kapalı

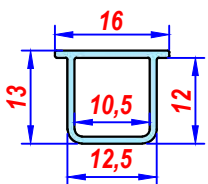

PROFİL 305 cm-OPAL

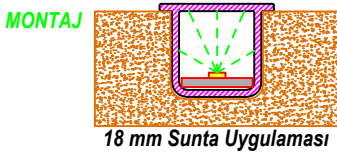

18 mm Sunta Uygulaması

YENİ

GP-021

PC. Led Prf.
POLİKARBONAT

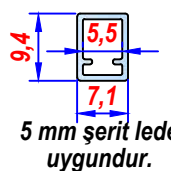

MONTAJ 2/1

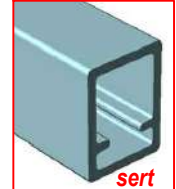
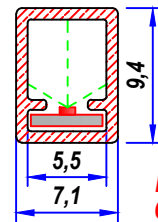

Mutfak, Mobilya, Dolap ve Çekmece içinde kullanıma uygun yeni ürün. Islak zeminlerde IP 66 kullanıma uygundur.

GP-031

Plastik Led Prf.(Açık)
Yatak Başı

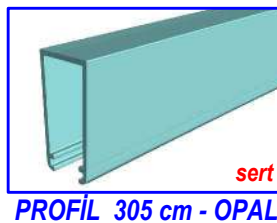
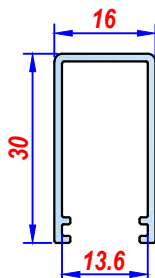

PROFİL 305 cm - OPAL

MONTAJ

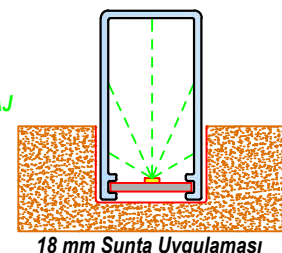

18 mm Sunta Uygulaması

KÜÇÜK (8x13,5 mm) EKONOMİK, SIVA ALTI-GÖMME ALM. LED PROFİL VE AKSESUARLARI

YA-020 Y

Alm.Led Kasa

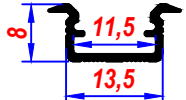

PCB genişliği, 11,5 mm

YA-019 C

PC.Cam-Difüzör



Opal, Şeffaf
Füme PC, çok yakında

Y-019 C

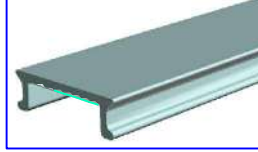

PC. Difüzör 610 cm

DOLAP İÇİ UYGULAMA



Kullanım alanları; Mobilya, Mutfak, Zemin, Duvar vb.

EKONOMİK GÖMME LED PRF.

YA-020 ALM. Y-019 C PC.

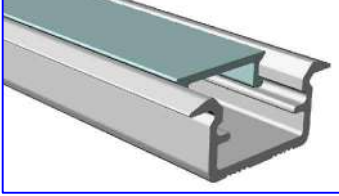

PC.DİFÜZÖR-ALM.PRF. 610 cm

YA-020 T

Pls. Kenar Tapa

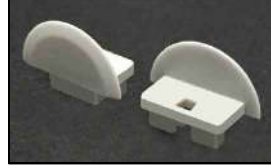

RENK ; Açık Gri

Mobilya sektöründe, özellikle dolap ve çekmece içi aydınlatmaya uygun ürün

YA-002

Gömme Alm.Kasa

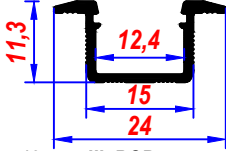

12 mm lik PCB ye uygun

YA-002 A

P.C. Difüzör



Opal-Şeffaf

YA-002 P

P.C. Difüzör



YA-002 B

Pls.Kenar Tapa



RENK ; A.Gri

Kullanım alanları; Mobilya, Mutfak, Zemin, Duvar vb.
Yeni, düz PC.Difüzör

YA-002 ALM.

Y-002 A-P PC.

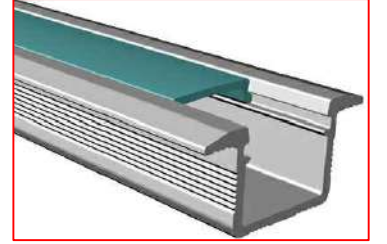

PC.DİFÜZÖR-ALM.PRF. 610 cm

DOLAP İÇİ UYGULAMA



YA-1002

Gömme Alm.Kasa

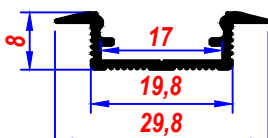

16 mm lik PCB ye uygun

YA-1002 A

P.C. Difüzör



Opal - Şeffaf

YA-1002 T

Pls.Kenar Tapa



RENK ; A.Gri

YA-1002 ALM.

Y-1002 A PC.

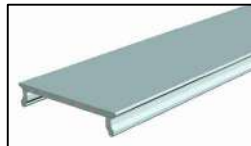

P.C.FİZÜZÖR 610 cm

Dekoratif Gömme Led Profili
Kullanım alanları; Mobilya, Mutfak, Zemin, Duvar vb.
Yüksekliği düşük, H=8 mm

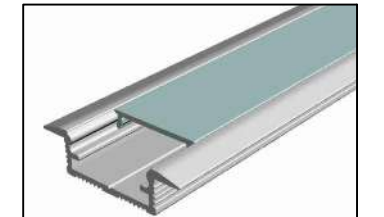

PC.DİFÜZÖR-ALM.PRF. 610 cm

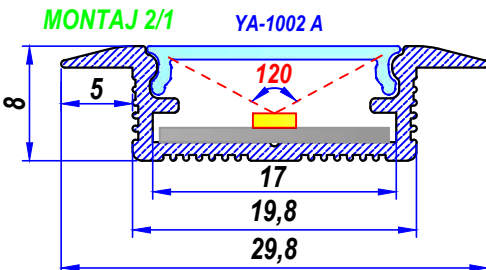

İstenilen ölçülerde kesim yapılır - İstenilen renge boyanır

All cutting dimensions and surface coatings can be done according to requirements

EKONOMİK SIVA ALTI (GÖMME), ALM. LED PROFİL VE AKSESUARLARI

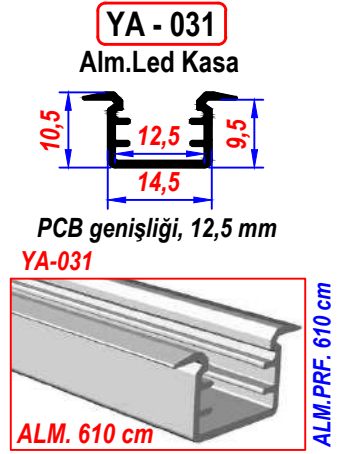
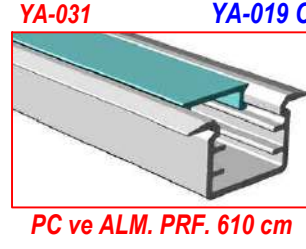
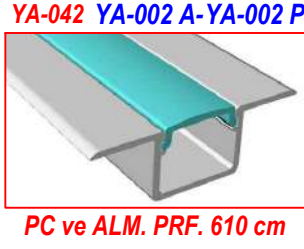
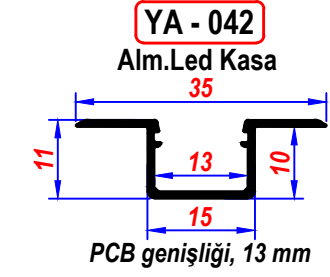

İKİ FARKLI DİFÜZÖR

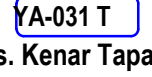
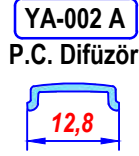

RENK ; Açık Gri



MONTAJ YA-042

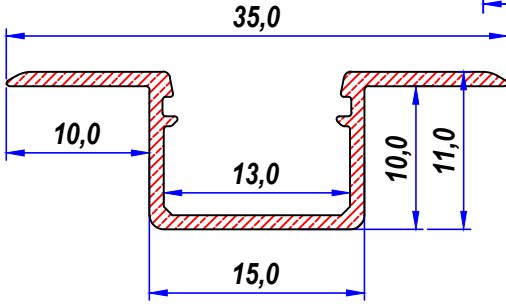

KULLANIM ALANLARI
Mobilya (Dolap ve çekmece içi),
Seramik-Duvar-Zemin-Merdiven
ahşap gibi yüzelerde kullanıma,
uygun, Dekoratif ve ekonomik
küçük, siva altı ÜRÜNLER

MONTAJ YA-031

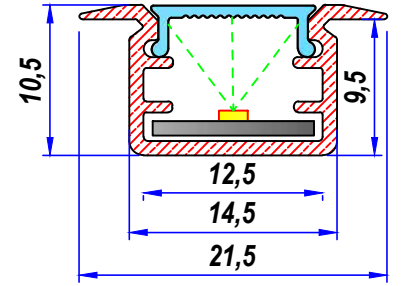

SIVA ALTI-GÖMME ALM. LED PROFİL VE AKSESUARLARI

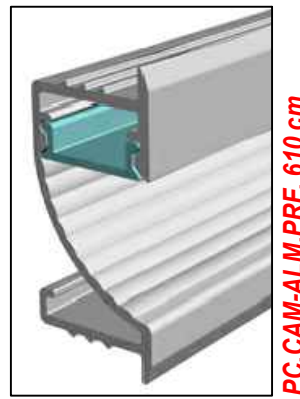
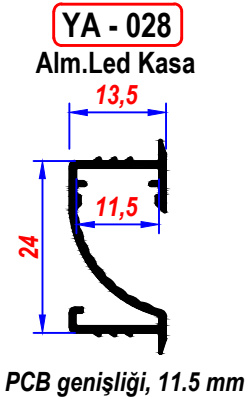

MONTAJ 2/1

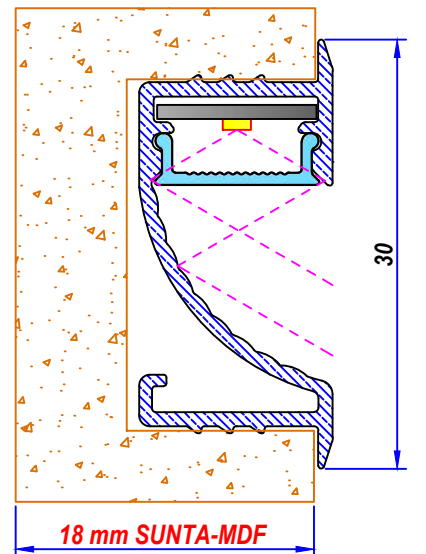

KULLANIM ALANLARI
Mobilya (Dolap ve çekmece içi), Duvar-zemin
Merdiven-ahşap gibi yüzelerde, siva altı
kullanımlara uygun, ışık kaynağı görülmeyen,
(Endirekt aydınlatma) siva altı yeni ürün

İstenilen ölçülerde kesim yapılır - İstenilen renge boyanır
All cutting dimensions and surface coatings can be done according to requirements

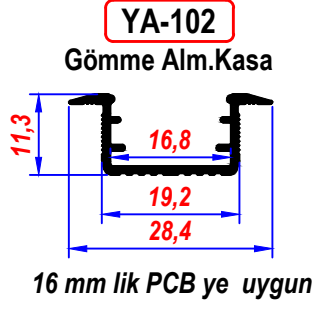

DEKORATİF GÖMME LED PROFİLİ



Kullanım alanları; Mobilya, Mutfak, Zemin, tavan, Duvar vb.

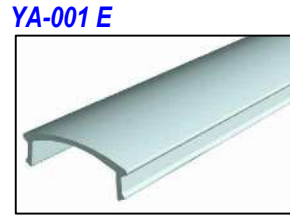
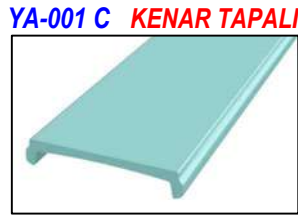
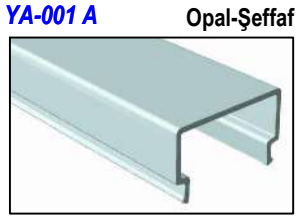
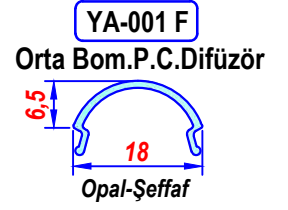
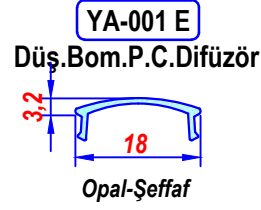
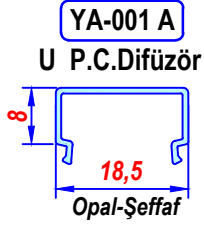

PC.DİFÜZÖR-ALM.PRF. 610 cm

PC.DİFÜZÖR, OPAL-ŞEFFAF

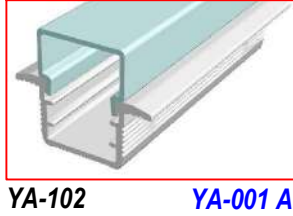

YA-102 YA-001 A

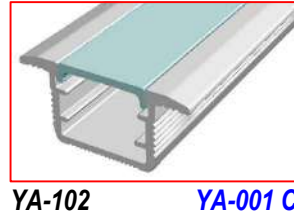

YA-102 YA-001 C

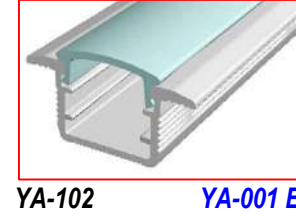

YA-102 YA-001 E

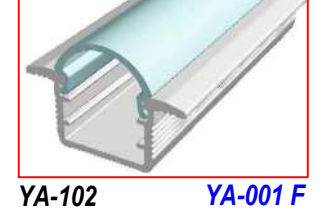

YA-102 YA-001 F

YA-102 ALM. LED KASA UYGULAMALARI



YA-102 ALM. LED KASA ve AKSESUARLARI

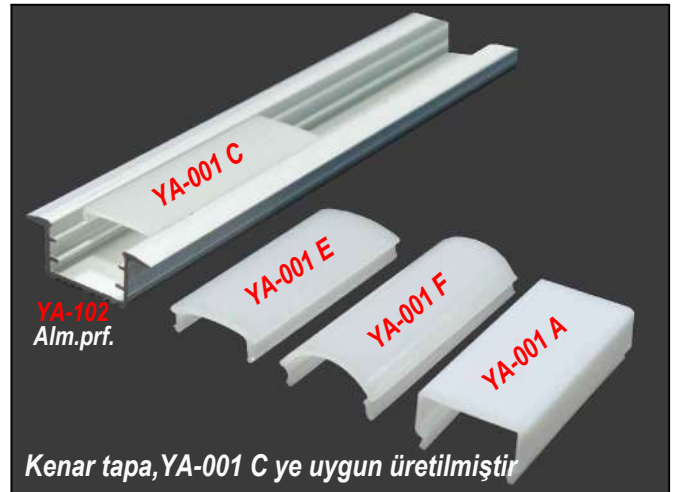

İstenilen ölçülerde kesim yapılır - İstenilen renge boyanır
All cutting dimensions and surface coatings can be done according to requirements

ALM. LED - AVİZE PROFİL VE AKSESUARLARI

AVZ-001

Alm.Led-Avize Kasa

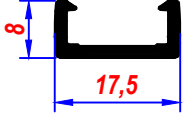

MONTAJ

AVZ-001 P

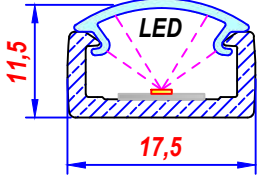

AVZ-001 ALM.

AVZ-001 PS
AVZ-001 S

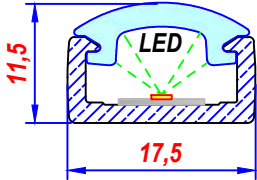

AVZ-001 ALM.

Aksesuarların tamamı,
Kaplama ve Boyamaya
uygun üretilmiştir.

AVZ-001 P

PC Cam-Difüzör

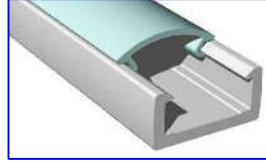

AVZ-001 S

Silikon Cam-Difüzör

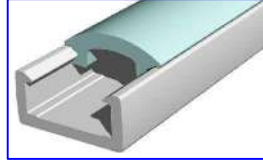
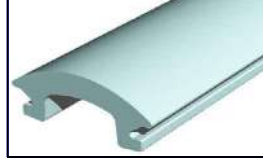
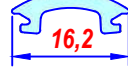

AVZ-001 PS

Modifiye Silikon

18 mm EKONOMİK ÜRÜN
50 mt-OPAL

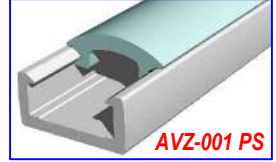

Mevcut Aksesuar ve difüzörler
Yeni üretilen YA-001 Alm. Profile uygundur

AVZ-001 T

Pls. Ken. Tapa



A.Gri - Naturel

AVZ-001 T1

Pls.Rözens Bağlt.Aparatı



A.Gri - Naturel

AVZ-001 YN

Pls. Askı Aparatı



A.Gri - Naturel

AVZ-001 AN

Pls. Askı Aparatı



A.Gri-Naturel

ALTTAN NİPELLİ

YENİ AVZ-001 TN

Pls. Askı Aparatı



A.Gri-Naturel

ÜSTTEN VİDALI

AVZ-001 DY

Pls. Vidalı Ayıp Örten Aparatı



Naturel

AVZ-001 AY

Pls. Ayıp Örten Aparatı



Naturel

AVZ-001 HN

Pls. Askı Aparatı



Naturel

Yeni Üretilen Plastik askı aparatları, çap 9,5 mm lik NİPEL e uygundur
Büküme uygun sertlikde, alüminyum profiller satışa sunulmuştur

DAİRESEL ALM. LED - AVİZE PROFİL VE AKSESUARLARI

AVZ-002
Alm.Led-Avize Kasa

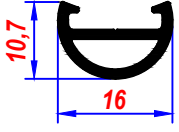

PC. DİFÜZÖR

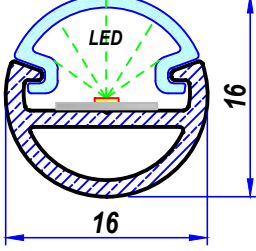

MONTAJ 2/1

SLİKON DİF.

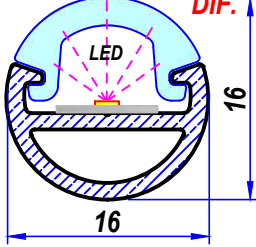

3 FARKLI DİFÜZÖR

AVZ-002 P
PC Cam-Difüzör

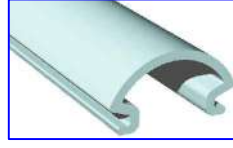

PC.PRF. 610 cm

AVZ-002 S
Silikon Cam-Difüzör

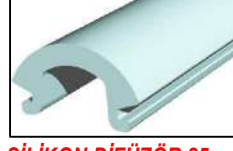

SİLİKON DİFÜZÖR 25 mt

16 mm EKONOMİK ÜRÜN

AVZ-002 PS
Modifiye Silikon

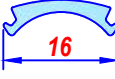

MODİFİYE SİLİKON D 25 mt

AVZ-001 PS
Modifiye Silikon

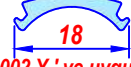

AVZ-002 Y 'ye uygun ürün
18 mm EKONOMİK ÜRÜN

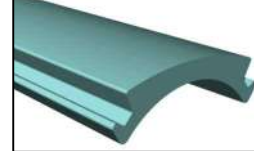

DİFÜZÖR 50 mt-OPAL
ALM.PRF.-MOD.SİLİKON

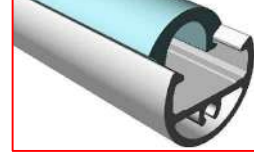

AVZ-002 Y
Alm.Led-Avize Kasa

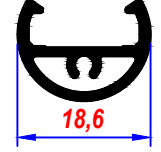

AVZ-001 PS

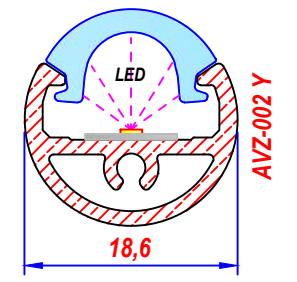

AVZ-002 Y

MODERN LED AVİZE UYGULAMALARI



Krom Kaplama

AVZ-002 ye uygun



AVZ-002 Y ye uygun

BÜKÜME UYGUN SERTLİKTE, TEK YÖNLÜ DAİRESEL ALÜMİNYUM PROFİLLER

İKİ YÖNLÜ DAİRESEL ALM. LED - AVİZE PROFİL VE AKSESUARLARI

AVZ-003
Alm.Led-Avize Kasa

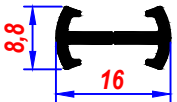

BÜKÜME UYGUN SERTLİKTE,
ÇİFT YÖNLÜ ALÜMİNYUM PROFİL

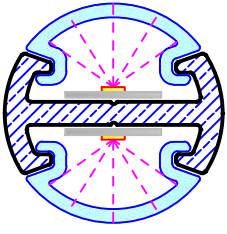

PC DİF.

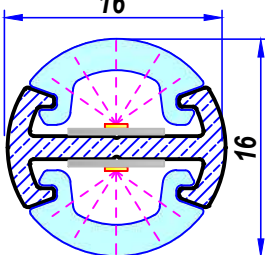

SLİKON DİF.

MONTAJ 2/1

AVZ-003 P
PC Cam-Difüzör



ALM.-PC.PRF. 610 cm

AVZ-003 S
Silikon Difüzör

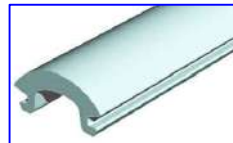

SİLİKON DİFÜZÖR 25 mt

AVZ-003 PS
Modifiye Silikon



PC. ve SLİKON Difüzör rengi, OPAL

AVZ-002 T
Metal. Kenar Tapa



Çap 16 mm

Paslanmaz

ÇİFT YÖNLÜ DİFÜZÖR

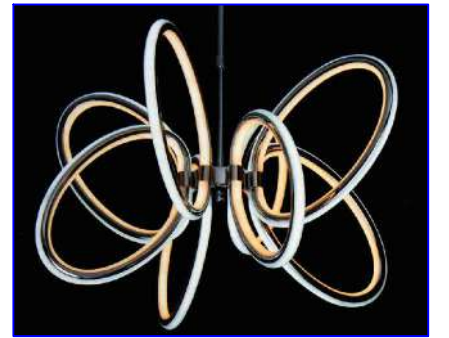

İKİ FARKLI, MODERN LED
AVİZE UYGULAMASI



ÇİFT YÖNLÜ ALÜMİNYUM

İstenilen ölçülerde kesim yapılır - İstenilen renge boyanır
All cutting dimensions and surface coatings can be done according to requirements

YENİ İKİ YÖNLÜ ALM. LED - AVİZE PROFİL VE AKSESUARLARI

YENİ
AVZ-008

Alm.Led-Avize Kasa

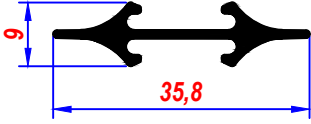

Büküme uygun sertlikde, çift yönlü modern yeni alüminyum profil.
İstenilen ral kodlarında, renk seçeneği

AVZ-001 PS

Modifiye Silikon

18 mm EKONOMİK ÜRÜN

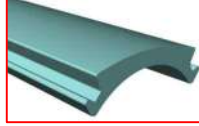

DİFÜZÖR 50 mt-OPAL

AVZ-001 PS

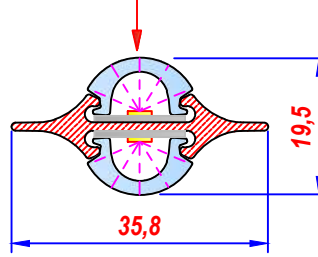

Çift taraflı, iki farklı ışık uygulanabilir

UYGULAMA

AVZ-008

AVZ-001 PS

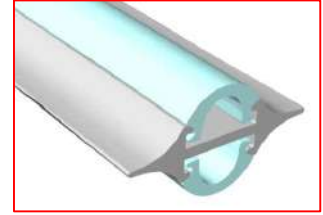

ALM. PRF. 610 cm

AVZ-010

Alm.Led Avize Profili

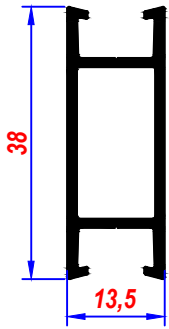

AVZ-010 P

PC Difüzör

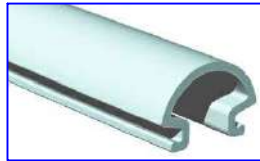

ALM-PC-PRF. 610 cm

AVZ-010 S

Silikon Difüzör

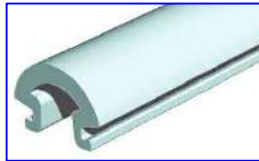

SİLİKON DİFÜZÖR 25 mt

MONTAJ

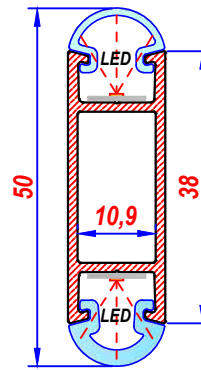

AVZ-010 Alm. Prf.

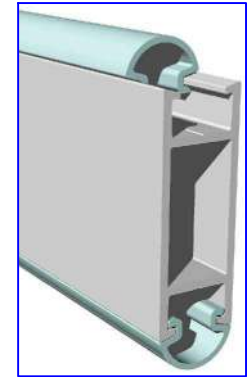

AVZ-010 P PC Difüzör
AVZ-010 S Silikon

AVZ-011

Alm.Led Avize Profili

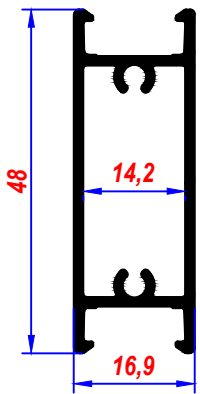

AVZ-011 MONTAJ

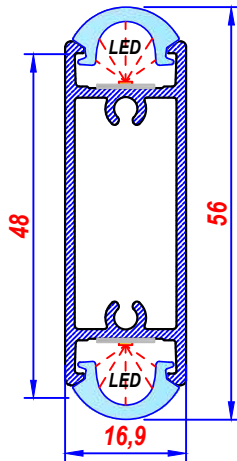

AVZ-001 PS



18 mm EKONOMİK ÜRÜN

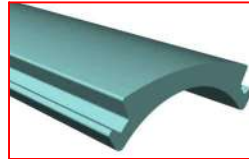

DİFÜZÖR 50 mt-OPAL
Süper ışık geçirgenliği

AVZ-011 T

Alm. Lazer Ken.Tapa

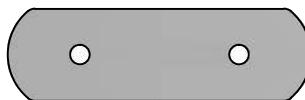

AVZ-001 P

PC.Cam-Difüzör



PC. Difüzör 610 cm-OPAL

AVZ-011 Alm.Prf.

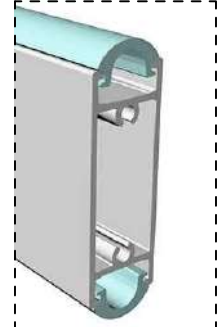

AVZ-001 P PC Difüzör
AVZ-001 PS Silikon

ÇİFT YÖNLÜ MODERN S



ÇİFT YÖNLÜ MODERN C



- * Büküme uygun sertlikde, alm. profil
- * İstenilen ölçü ve şekilde, özel üretim yapılır
- * İstenilen ral kodlarında, renk seçeneği
- * AVZ-010 dan farkı, büyük ve gösterişli olması
- * Tek yönlü difüzör kullanımına uygun

YENİ TEK TARAFLI LED-AVİZE PROFİL VE AKSESUARLARI

YENİ

AVZ-013

Alm.Led-Avize Kasa

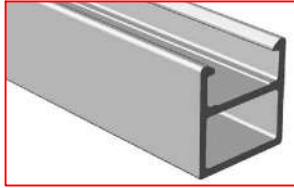
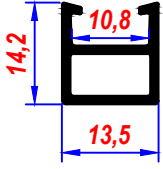

Bu üründe difüzör olarak,
AVZ-010 P - AVZ 010 S kullanılır

AVZ-010 P

PC Difüzör



AVZ-010 S

Slikon Difüzör



SLICON DİFÜZÖR 25 mt-OPAL

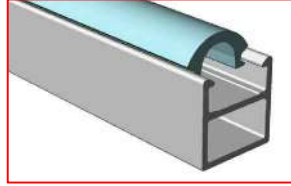

ALM. PRF. 610 cm

YENİ tek taraflı Alm. AVİZE profili,
büküme uygun sertlikde üretilmiştir.
İstenilen ral kodunda, renk seçeneği.
Boya ve kaplamaya uygun aksesuar
Işık geçirgenliği yüksek, 2 DİFÜZÖR

UYGULAMA

AVZ-010 P
PC.Difüzör

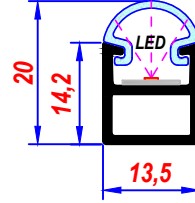

AVZ-010 S
Slikon

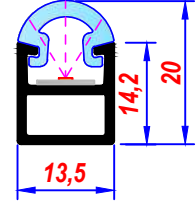

AVZ-012

Alm.Led Kasa

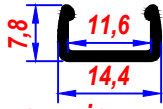

AVİZEYE UYGUN, İÇ TIRNAKSIZ KASA

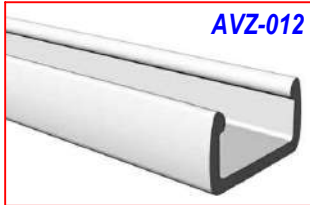

AVZ-012

YA-012 A

P.C. Difüzör



Opal - Şeffaf

YA-012 A



AVZ-012

YA-012 A

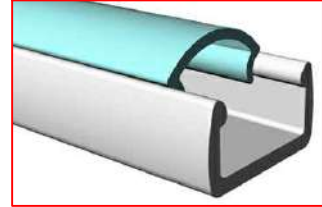

Büküme uygun sertlikde, alm.profil.
İstenilen ral kodunda, renk seçeneği.
Boya ve kaplamaya uygun aksesuar
Işık geçirgenliği yüksek, DİFÜZÖR

ALM. PRF. ve PC. DİFÜZÖR ler 610 cm

AVZ-012 MONTAJ

AVZ-012 T1

Pls. Rözans
Bağlantı Aparatı



Kaplamaya uygun

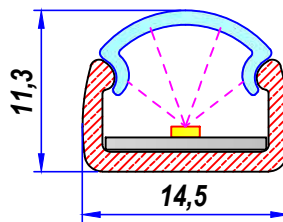

A.Gri-Naturel



AVZ-012 T

Pls. Tapa
Sonlandırma

Kaplamaya uygun

AVİZE AKSESUARLARI

AVZ-BE 1

Kollektör



Gold-Krom-Siyah

AVZ-BE 2

Kilitleme Aparatı-Maşon



Gold-Krom-Siyah

AVZ-BE 3

Minik Askı Tel Tutucu



Gold-Krom-Siyah

AVZ-BE 4

Alçıpan Montaj yayı



Krom Kaplama

AVZ-BE 5

Rözans Askı Aparatı



Krom Kaplama

İstenilen ölçülerde kesim yapılır - İstenilen renge boyanır
All cutting dimensions and surface coatings can be done according to requirements

3 ÇEŞİT, BÜKÜLEBİLİR ALM. LED - AVİZE PROFİL VE AKSESUARLARI

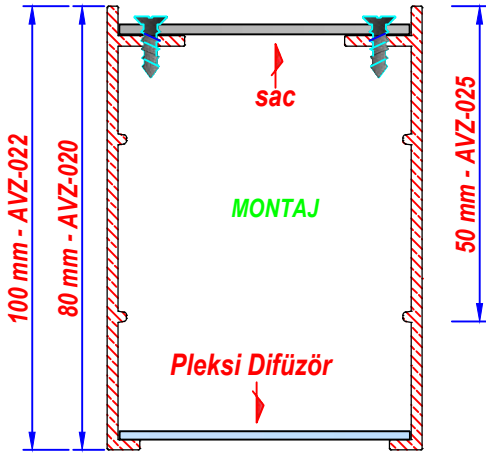
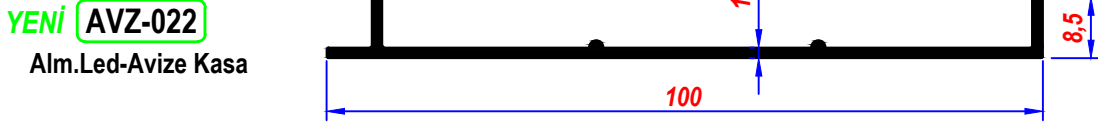
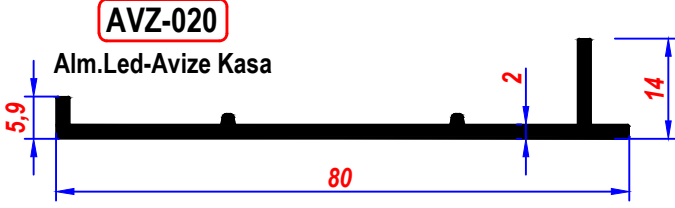

P.C.- ALM.PRF. 610 cm

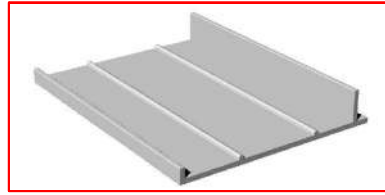

AVZ-020

YENİ AVZ-025



SİMİT

ÜÇGEN SİMİT



ÜÇGEN DAVUL



- * Büküme uygun sertlikde, alm. profil
- * İstenilen ölçü ve şekilde, özel üretim yapılır
- * İstenilen ral kodlarında, renk seçeneği

KARE OVAL SİMİT



BULUT



KARE DAVUL



ÇİZGİ

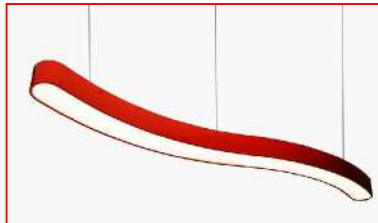

GAMZE



ÜÇGEN OVAL DAVUL

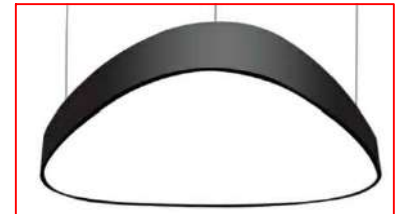

DAVUL



ALTİGEN SİMİT-DAVUL



ÜÇGEN YILDIZ



İstenilen renk ve ölçüde üretilir

İstenilen ölçülerde kesim yapılır - İstenilen renge boyanır

All cutting dimensions and surface coatings can be done according to requirements

AVZ-015
Alm.Led-Avize Kasa

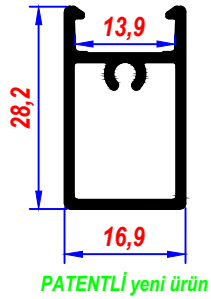

ALM. PRF. 610 cm

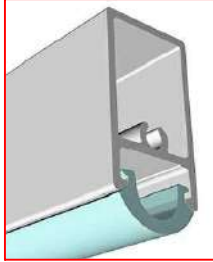

Bu üründe difüzör olarak,
AVZ-001 PS kullanılır

TEK TARAFLI 2 li SİMİT AVİZE



AVZ-001 PS

Modifiye Silikon

18 mm EKONOMİK ÜRÜN

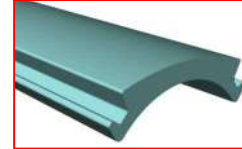

DİFÜZÖR 25 mt-OPAL

MONTAJ
AVZ-001 PS

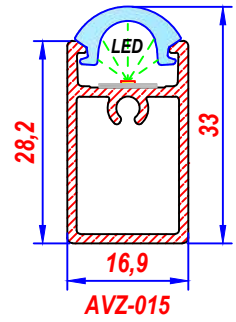

AVZ-017
Alm.Led-Avize Kasa

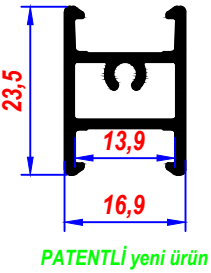

ALM. PRF. 610 cm

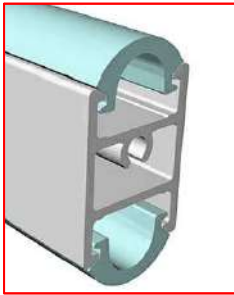

Bu üründe difüzör olarak,
AVZ-001 PS kullanılır



Çift taraflı aydınlatan AVİZE

Büküme uygun sertlikde, alm.profil,
İstenilen ral kodunda, renk seçeneği
Boya ve kaplamaya uygun aksesuar
Işık geçirgenliği yüksek, DİFÜZÖR
Aksesuarları, çok yakında çıkacaktır

AVZ-001 PS

Modifiye Silikon

18 mm EKONOMİK ÜRÜN



DİFÜZÖR 25 mt-OPAL

MONTAJ
AVZ-001 PS

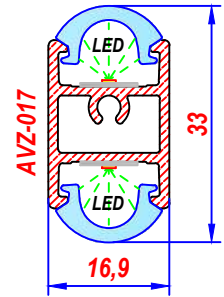

YENİ ALM. TEK TARAFLI LED-AVİZE PROFİL VE AKSESUARLARI

YENİ

AVZ-018

Alm.Led-Avize Kasa

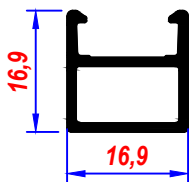

ALM. PRF. 610 cm

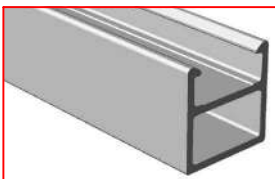

Bu üründe difüzör olarak,
AVZ-001 PS kullanılır

AVZ-001 PS

Modifiye Silikon

18 mm EKONOMİK ÜRÜN

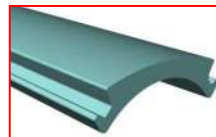

DİFÜZÖR 25 mt-OPAL

Tek taraflı ışık, aydınlatma

Büküme uygun sertlikde, alm.profil,
İstenilen ral kodunda, renk seçeneği
Boya ve kaplamaya uygun aksesuar
Işık geçirgenliği yüksek, DİFÜZÖR
Aksesuarları, çok yakında çıkacaktır

MONTAJ
AVZ-001 PS

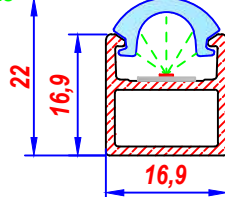

DİFÜZÖR 25 mt-OPAL

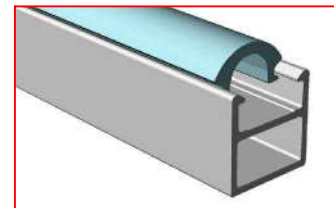

ALM. PRF. 610 cm

İstenilen ölçülerde kesim yapılır - İstenilen renge boyanır
All cutting dimensions and surface coatings can be done according to requirements

3 lü ve 2 li DİFÜZÖRE UYGUN, YENİ ALM. LED-AVİZE PROFİL VE AKSESUARLARI

AVZ-045

Alm.Led-Avize Kasa

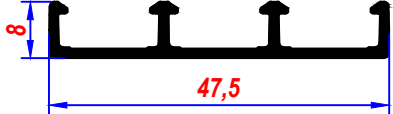

3 lü ve 2 li led kullanımına uygun

AVZ-001 PS

Modifiye Silikon

18 mm EKONOMİK ÜRÜN
DİFÜZÖR 25 mt - OPAL

Işık geçirgenliği yüksek, OPAL DİFÜZÖR
Kaplama ve boyaya uygun plastik aparatlar

AVZ-045 TN

Pls. Aski Aparatı



Kaplamaya Uygun

AVZ-045 T

Pls. Kenar Tapa



ÜÇ veya İKİ DİFÜZÖR UYGULANABİLİR

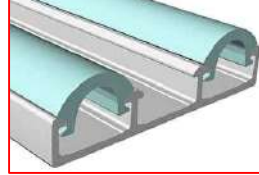

Büküme uygun sertlikde, alm.profil,
İstenilen ral kodunda, renk seçeneği



Bu üründe difüzör yan yana,
2 veya 3 sıra kullanılabilir

AVZ-050

Alm.Led-Avize Kasa
PATENTLİ yeni ürün

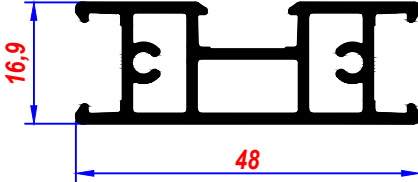

3 lü ve 2 li KULLANIMA UYGUN
YENİ ÜRÜN

AVZ-001 PS

Modifiye Silikon

18 mm EKONOMİK ÜRÜN

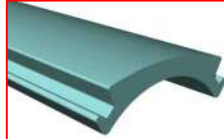

ALM. PRF. 610 cm

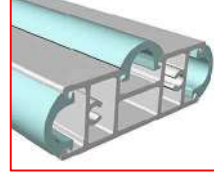

Bu üründe difüzör olarak,
AVZ-001 PS kullanılır

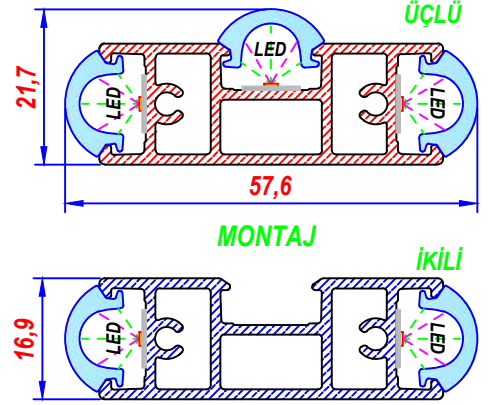

AVZ-051

Alm.Led-Avize Kasa

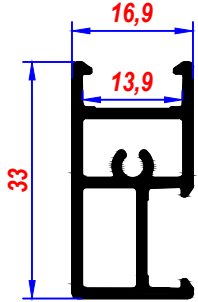

2 li KULLANIMA UYGUN PATENTLİ yeni ürün

AVZ-001 PS

Modifiye Silikon

18 mm EKONOMİK ÜRÜN

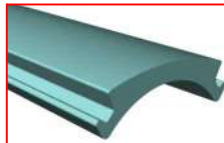

ALM. PRF. 610 cm

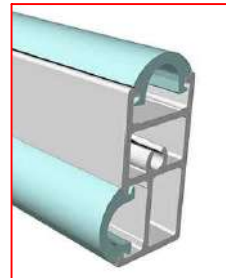

Bu üründe difüzör olarak,
AVZ-001 PS kullanılır

MONTAJ

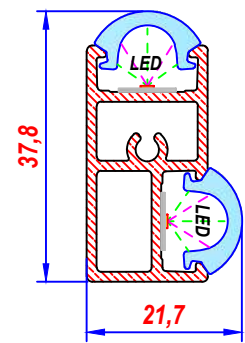

AVZ-040

Alm.Led-Avize Kasa

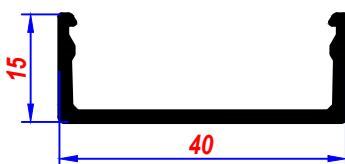

YA-1209 A

P.C. Difüzör

Kumlu Opal
P.C. DİFÜZÖR 610 cm

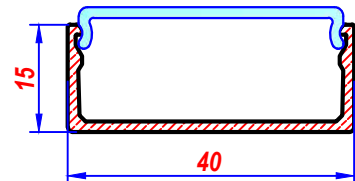

İstenilen ölçülerde kesim yapılır - İstenilen renge boyanır

All cutting dimensions and surface coatings can be done according to requirements

LED-AVİZE PROFİL VE AKSESUARLARI

AVZ-030

Alm.Led-Avize Kasa

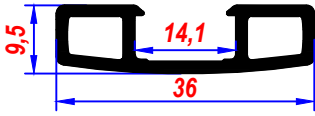

Bu üründe difüzör olarak, AVZ-001 P, AVZ-001 S ve AVZ-001 PS kullanılır

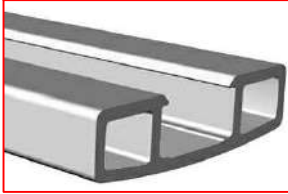

ALM. PRF. 610 cm

Büküme uygun sertlikde, alm.profil,
3 farklı difüzör seçeneği,
Boya ve kaplamaya uygun aksesuar
İstenilen ral kodunda, renk seçeneği

AVZ-001 P

PC Cam-Difüzör

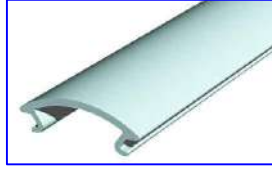

ALM.-PC.PRF. 610 cm

AVZ-001 S

Silikon Cam-Difüzör

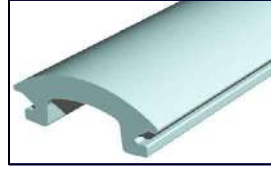

SİLİKON DİFÜZÖR 25 mt

AVZ-001 PS

Modifiye Silikon



18 mm EKONOMİK ÜRÜN

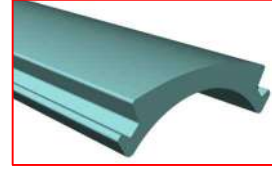

DİFÜZÖR 25 mt-OPAL

AVZ-030 DY

Pls.Ayıp Örtme Aparatı



2 Vidalı Aparat

AVZ-030 T

Pls. Kenar Tapa



Ürün Sonlandırma Tapası

AVZ-030 TN

Pls. Askı Aparatı



Üstten Nipelli

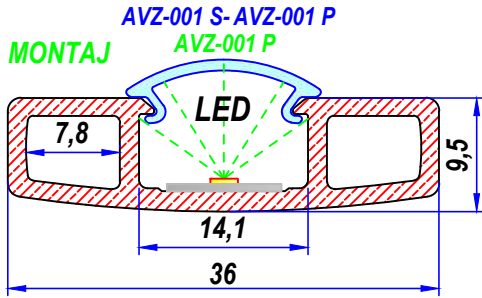

Aksesuarların tamamı, boya ve kaplamaya uygun üretilmiştir

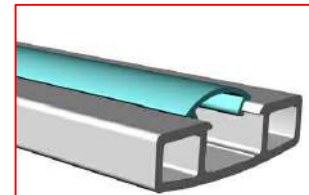

PC. DİFÜZÖR - ALM. PRF. 610 cm

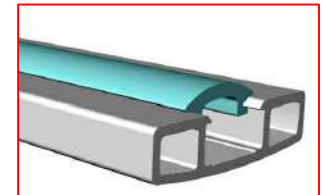

SİLİKON DİFÜZÖR - ALM. PRF.

AVZ-005

Alm.Led-Avize Kasa

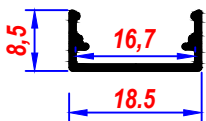

YA-001 A

U P.C.Difüzör

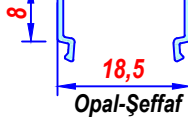

Opal-Şeffaf

YA-001 C

Düz P.C.Difüzör

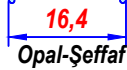

Opal-Şeffaf

YA-001 E

Düş.Bom.P.C.Difüzör



Opal-Şeffaf

YA-001 F

Orta Bom.P.C.Difüzör

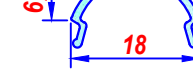

Opal-Şeffaf

YA-001 E Opal-Şeffaf



YA-001 F Opal-Şeffaf



YA-005 YA-001 E

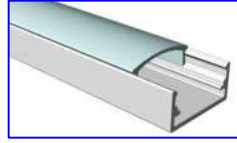

P.C.- ALM.PRF. 610 cm

YA-005 YA-001 F

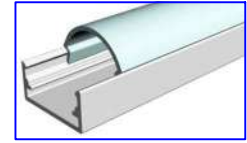

P.C.- ALM.PRF. 610 cm

YA-005 A

Düşük Bom.Pls. tapa



YA-005 B

Orta Bombeli Pls.tapa



MODERN, LED AVİZE UYGULAMASI



İstenilen ölçülerde kesim yapılır - İstenilen renge boyanır
All cutting dimensions and surface coatings can be done according to requirements

YENİ ALM. LED-AVİZE PROFİL VE AKSESUARLARI

YENİ
AVZ-041

Alm.Led-Avize Kasa

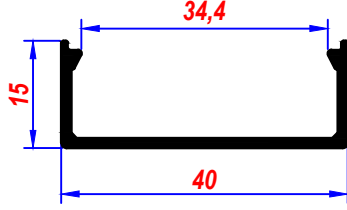

Büküme uygun sertlikde, alm.profil,
İstenilen ral kodunda, renk seçeneği

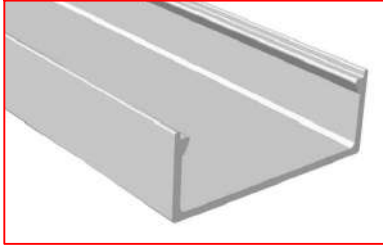

YENİ

YA-213 C

P.C. Difüzör



P.C. DİFÜZÖRLER 610 cm

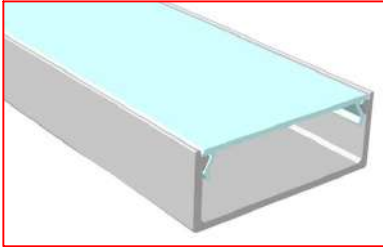

PC.DİFÜZÖR-ALM.PRF. 610 cm

YENİ

AVZ-042 434 gr

Alm.Led-Avize Kasa

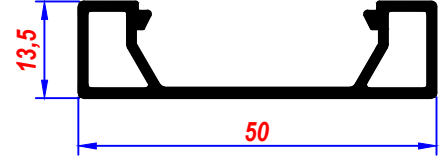

Büküme uygun sertlikde, alm.profil.
İstenilen ral kodunda, renk seçeneği.



YENİ

YA-214 C

PC.Cam-Difüzör

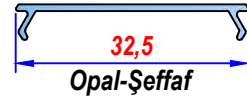

Boya ve kaplamaya uygun aksesuar
Işık geçirgenliği yüksek, DİFÜZÖR

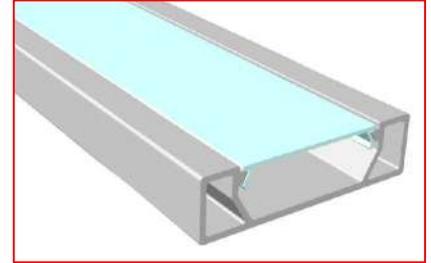

PC.DİFÜZÖR-ALM.PRF. 610 cm

ALÜMİNYUM KAYNAK TELİ - 5356 MİG-MAKARA

KALINLIK 1 - 1,2 mm



ALÜMİNYUM KAYNAK TELİ - 5356 TİG - ÇUBUK

KALINLIK 2 - 2,4 mm



İstenilen ölçülerde kesim yapılır - İstenilen renge boyanır
All cutting dimensions and surface coatings can be done according to requirements

ORTA, L KÖŞE (45°) ALM. PROFİL VE AKSESUARLARI

YA-016

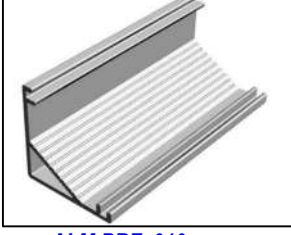

ALM. PRF. 610 cm

YA-016

Alm. Led Kasa

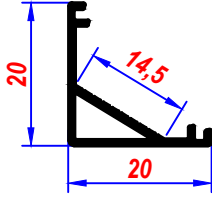

L KÖŞE Profili
12-14 mm lik PCB ye uygun

YA-016 A

Alm. Duvar Bağlantı Prf.

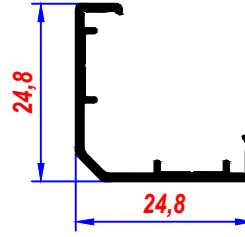

YA-016 A

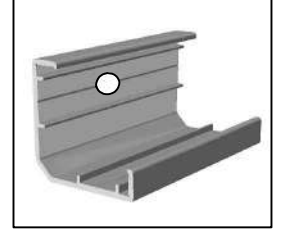

2 cm-Tek delikli
Ürün boy halinde de verilir

YA-016 B



P.C. DİFÜZÖR 610 cm

YA-016 B

P.C. Oval Difüzör

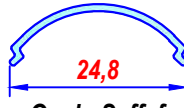

Opal - Şeffaf

YA-016 C

P.C. L Difüzör

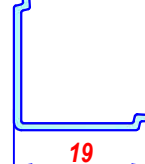

Opal - Şeffaf

YA-016 C

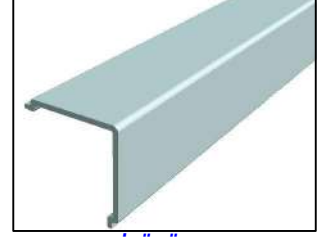

P.C. DİFÜZÖR 610 cm

YA-016 B 1

Pls. Kenar tapa



RENK ; Açık Gri

KULLANIM ALANLARI

45 derece ışık istenilen yerlerde,
Mutfak tezgah aydınlatma,
çekmece, dolap içi, zemin, duvar
köşe birleşim noktalarında kullanılır

YA-016 C 1

Pls. Kenar tapa



RENK ; Açık Gri

YA-016 ALM. LED KASA VE AKSESUARLARI

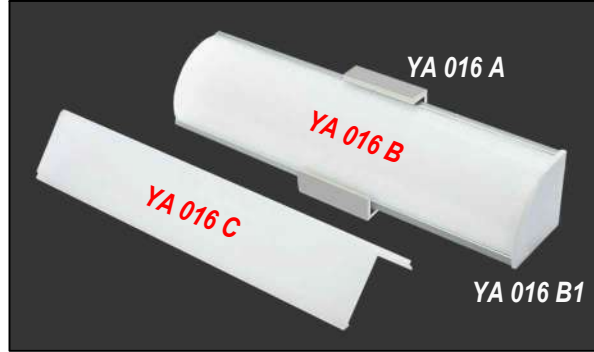

YA-016

YA-016 B

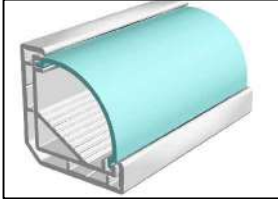

PC.DİFÜZÖR-ALM. PRF. 610 cm
12-14 mm lik PCB uygun

YA-016 YA-016 A YA-016 C

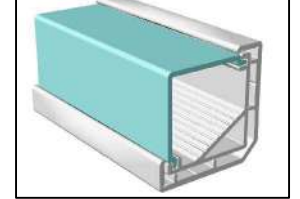

PC.DİFÜZÖR-ALM. PRF. 610 cm
12-14 mm lik PCB uygun

MUTFAK TEZGAH ÜSTÜ 45° AYDINLATMA



OVAL CAM UYGULAMA
MONTAJ

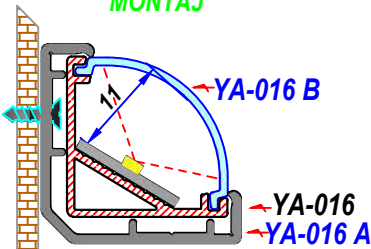

DUVAR-ZEMİN-MOBİLYA

L CAM UYGULAMA
MONTAJ

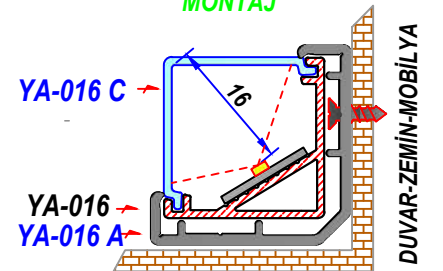

DUVAR-ZEMİN-MOBİLYA

İstenilen ölçülerde kesim yapılır - İstenilen renge boyanır
All cutting dimensions and surface coatings can be done according to requirements

KÜÇÜK, L KÖŞE (45°) ALM. PROFİL VE AKSESUARLARI

YENİ

YA - 027

Alm.Led Kasa

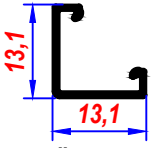

L KÖŞE Profili

12 mm lik PCB ye uygun

YA-012 A

P.C. Difüzör



Opal-Şeffaf

YA-012 A

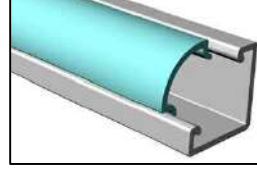

YA-027 Alm.Prof.

YA-019 C

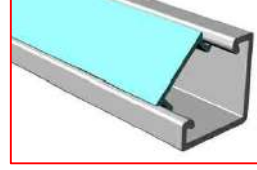

YA-019 C

PC.Cam-Difüzör



Opal-Şeffaf

PC.CAM-ALM.PRF. 610 cm

MONTAJ 2/1

YA-027 T

Pls. Kenar Tapa

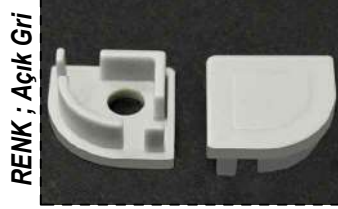

RENK ; Açık Gri

YA-012 A PC Difüzere uygun

KULLANIM ALANLARI

Mobilya (Dolap ve çekmece içi),
Mutfak dolap altlarında kullanıma
uygun, dekoratif ve ekonomik
minik sıva üstü köşe profili...

**YA-012 A Bombeli PC.Difüzöre
uygun, kenar tapa üretilmiştir.**

DUVAR-ZEMİN-MOBİLYA

BÜYÜK, L KÖŞE (45° 30x30 mm) ALM. PROFİL VE AKSESUARLARI

YA - 030

Alm.Led Kasa
L KÖŞE Profili

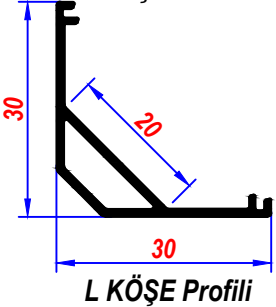

L KÖŞE Profili

YA-030 B

P.C. Oval Difüzör

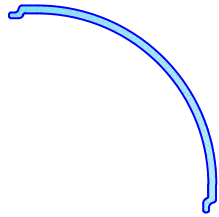

P.C. DİFÜZÖRLER 610 cm

12-16-20 mm lik PCB ye uygun

YA-030 C

P.C. L Difüzör

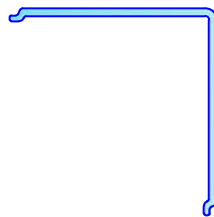

YENİ

YA-030 D

Alm. Duvar
Bağlantı Prof.

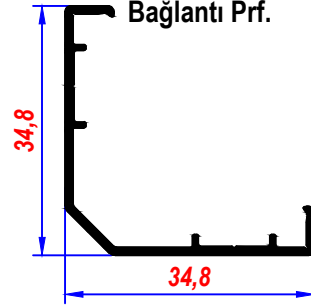

YA-030 A

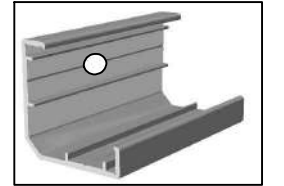

2 cm-Tek delikli
Ürün boy halinde de verilir

YA-030 B 1

Pls. Kenar tapa



YA-030 B ye Uygun

PC.-ALM.PRF. 610 cm

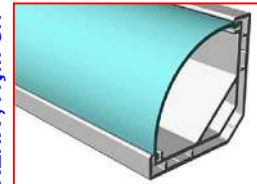

YA-030, YA-030 B

KULLANIM ALANLARI

45° derece ışık istenilen yerlerde,
Mutfak tezgah aydınlatma,
zemin, duvar köşe birleşim
noktalarında kullanılır

PC.-ALM.PRF. 610 cm

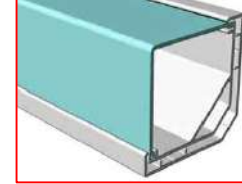

YA-030, YA-030 C

YA-030 C 1

Pls. Kenar tapa



YA-030 C ye Uygun

OVAL CAM UYGULAMA

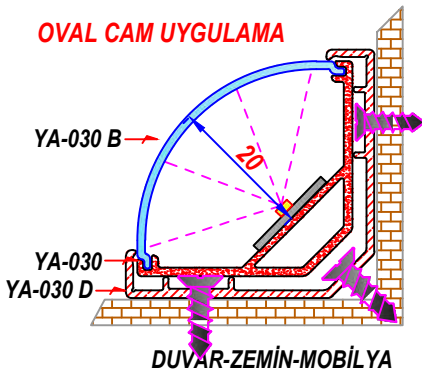

DUVAR-ZEMİN-MOBİLYA

MUTFAK TEZGAH ÜSTÜ 45° AYDINLATMA



L CAM UYGULAMA

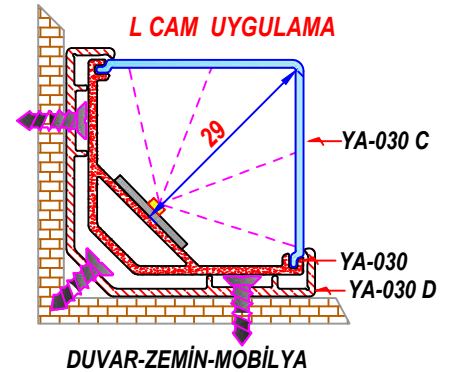

DUVAR-ZEMİN-MOBİLYA

İstenilen ölçülerde kesim yapılır - İstenilen renge boyanır

LEDLİ KARTONPİYER ALÜMİNYUM PROFİL ve AKSESUARLARI
ÇİFT TARAFLI, DEKORATİF AYDINLATMA

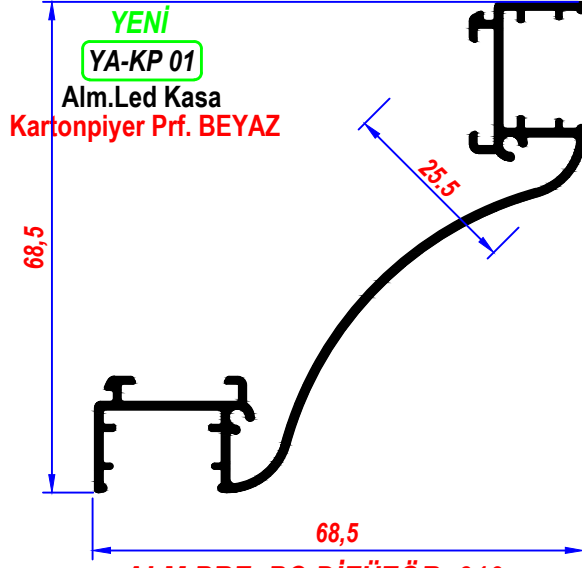

ALM.PRF.-PC DİFÜZÖR 610 cm

MONTAJ

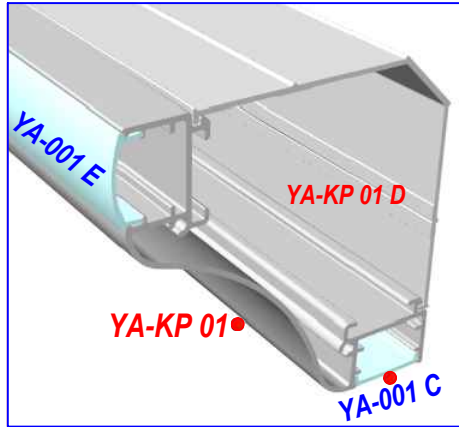

4 FARKLI DİFÜZÖR UYGULANABİLİR

YA-KP 01 D
Alm. Duvar
Bağlantı Prf.

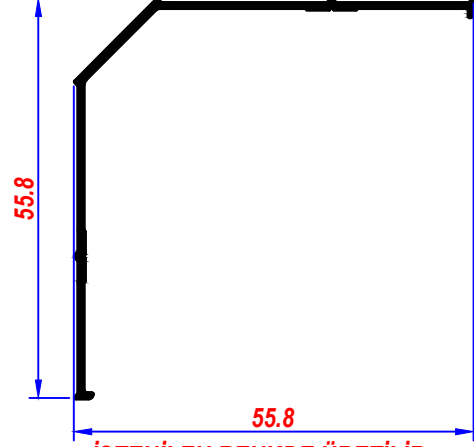

İSTENİLEN RENKDE ÜRETİLİR
İSTENİLEN ÖLÇÜLERDE KESİM YAPILIR
UYGULAMA



YA-001 C
Düz P.C.Difüzör



YA-001 C

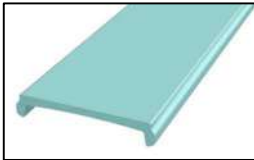

PC.DİFÜZÖR-ALM.PRF. 610 cm

YA-001 E
Düş.Bom.P.C.Difüzör

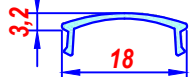

YA-001 E



Opal-Şeffaf

YA-001 A
U P.C.Difüzör

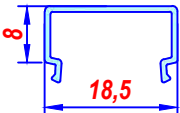

YA-001 F
Orta Bom.P.C.Difüzör

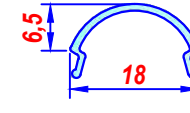

UYGULAMA

ALÇIPAN - TAVAN

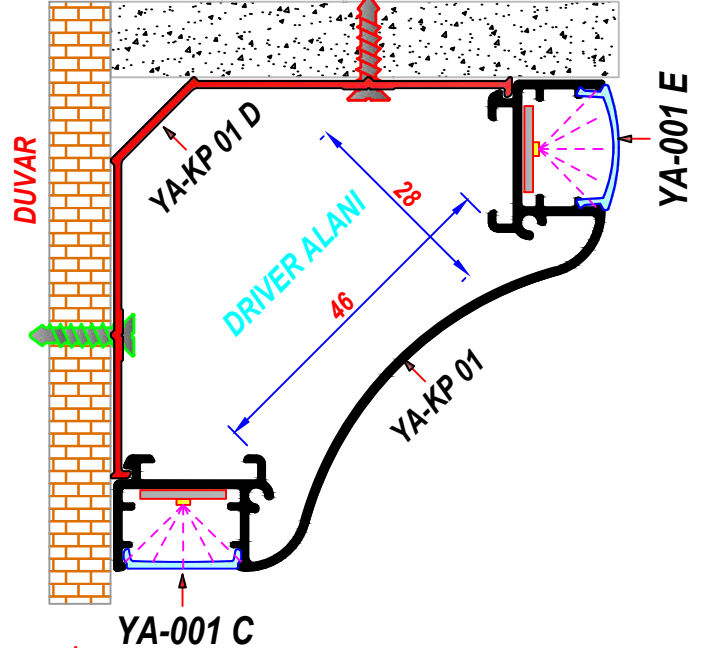

İstenilen ölçülerde kesim yapılır - İstenilen renge boyanır
All cutting dimensions and surface coatings can be done according to requirements

LEDLİ KARTONPİYER ALÜMİNYUM PROFİL ve AKSESUARLARI

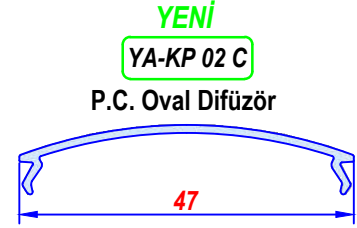
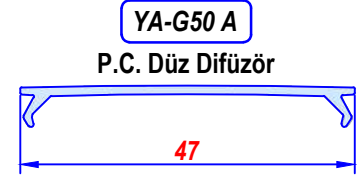
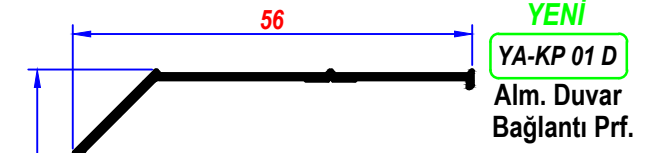
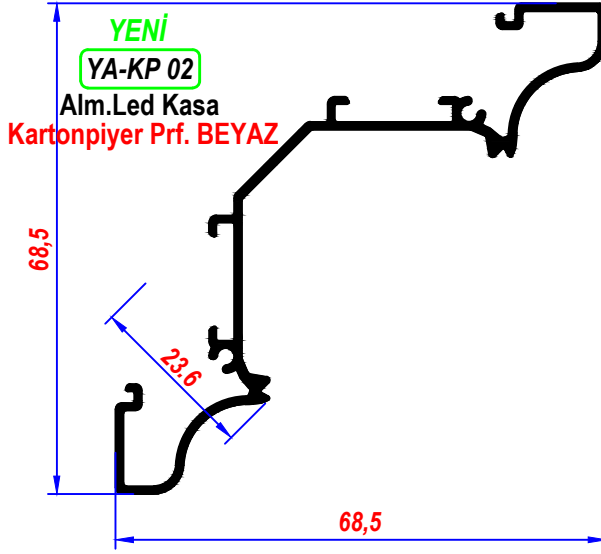

YENİ
YA-KP 02 TB
Alm.Lazer Ken.Tapa
Bombeli Difüzöre uygun

YENİ
YA-KP 02 TD
Alm.Lazer Ken.Tapa
Düz Difüzöre uygun

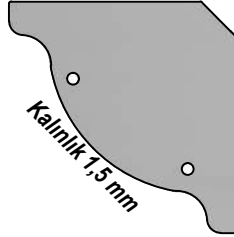

ALM.PRF.-PC DİFÜZÖR 610 cm

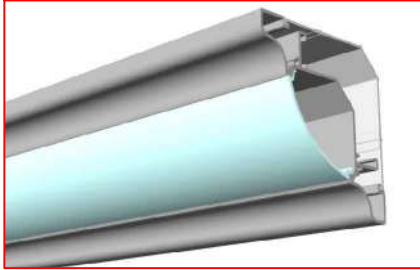

BOMBELİ DİFÜZÖR

2 FARKLI DİFÜZÖR UYGULANABİLİR

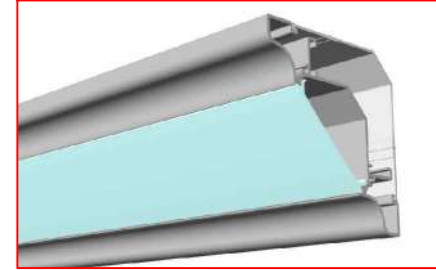

DÜZ DİFÜZÖR

İSTENİLEN RENKDE ÜRETİLİR
İSTENİLEN ÖLÇÜLERDE KESİM YAPILIR

BOMBELİ DİFÜZÖR UYGULAMA

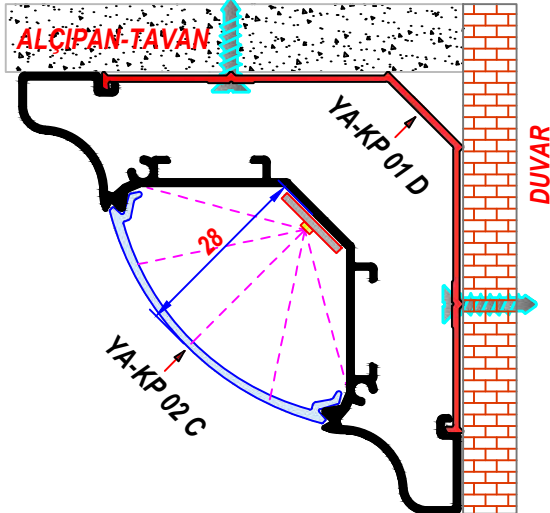

DÜZ DİFÜZÖR UYGULAMA

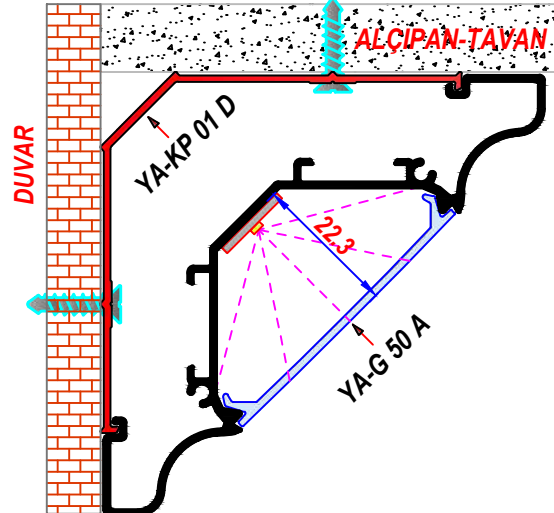

İstenilen ölçülerde kesim yapılır - İstenilen renge boyanır
All cutting dimensions and surface coatings can be done according to requirements

LEDLİ ALÇIPAN ALÜMİNYUM PROFİL ve AKSESUARLARI

YENİ

YA-KP 009

Alm.Led Kasa

Kartonpiyer Prof. BEYAZ

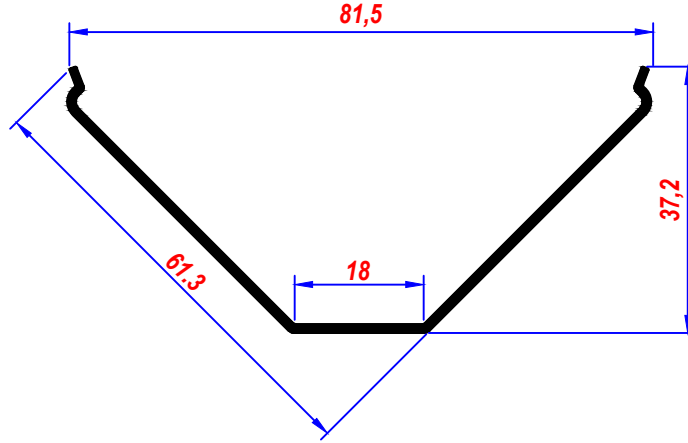

ALM.PROF.-PC DİFÜZÖR 610 cm

YA-209 A

**P.C.Difüzör
(İnce çizgili)**

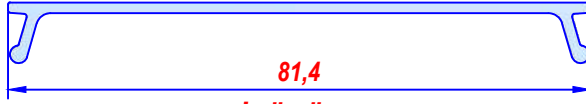

PC. DİFÜZÖR 610 cm

YA-209 A

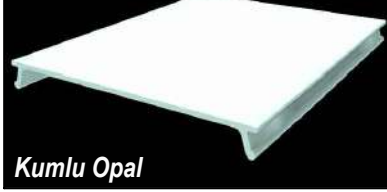

Kumlu Opal

PC.DİFÜZÖR-ALM.PROF. 610 cm

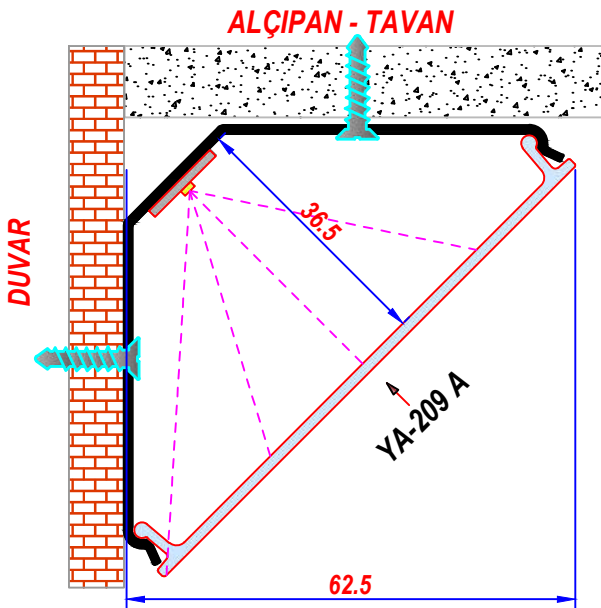

YA-KP 009 ALM. PROF.

YA-KP 009 PC. DİFÜZÖR

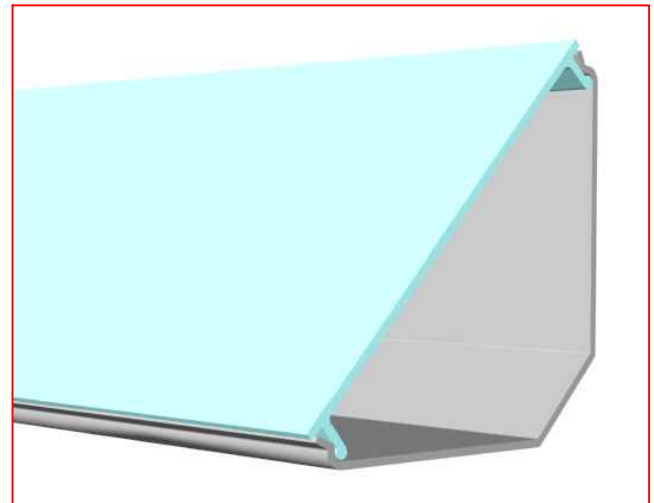

Alm. Prof. PC. Difüzör 610 cm

İstenilen ölçülerde kesim yapılır - İstenilen renge boyanır
All cutting dimensions and surface coatings can be done according to requirements

LEDLİ KARTONPİYER ALÜMİNYUM PROFİL ve AKSESUARLARI

YENİ
YA-KP 010
Alm.Led Kasa
Kartonpiyer Prf. BEYAZ

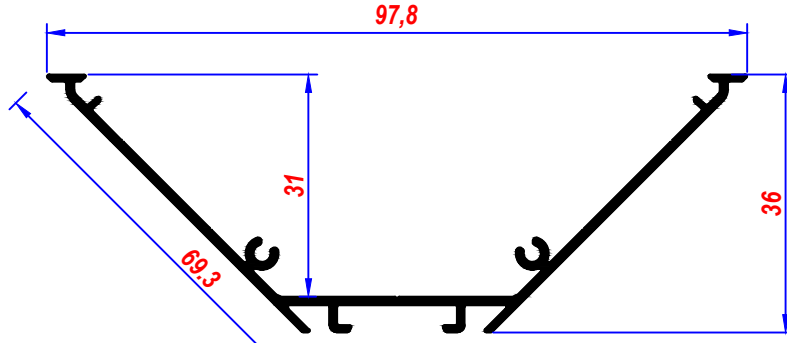

BOMBELİ DİFÜZÖR UYGULAMA



ALM.PRF.-PC DİFÜZÖR 610 cm

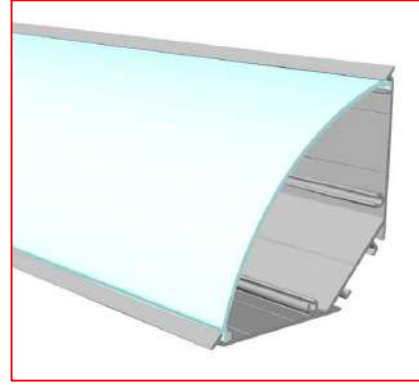

YA-206 G
P.C. Oval Difüzör
Opal - Çizgisiz

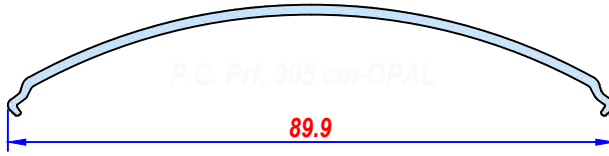

YENİ
YA-KP 010 C
P.C. Düz Difüzör

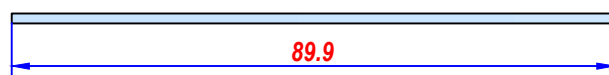

YENİ
YA-KP 010 TB
Alm.Lazer Ken.Tp.
Bombeli Difüzöre uygun

YENİ
YA-KP 010 TD
Alm.Lazer Ken.Tp.
Düz Difüzöre uygun

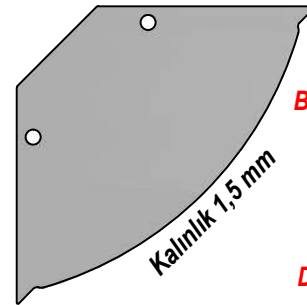

ALÇIPAN - TAVAN

TEK - İKİ SIRA LED KULLANILABİLİR

ALÇIPAN - TAVAN

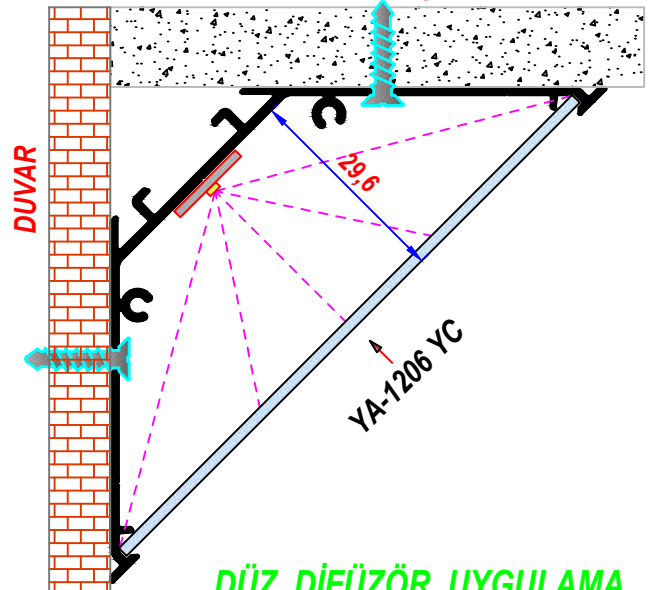
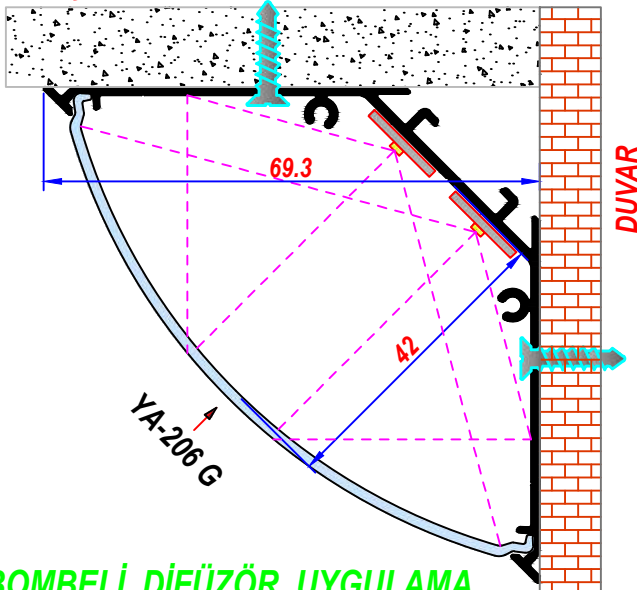

BOMBELİ DİFÜZÖR UYGULAMA

DÜZ DİFÜZÖR UYGULAMA

İstenilen ölçülerde kesim yapılır - İstenilen renge boyanır
All cutting dimensions and surface coatings can be done according to requirements

IŞIKLI ASKI BORU VE AKSESUARLARI

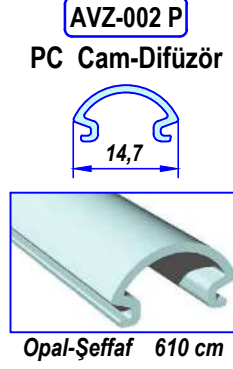
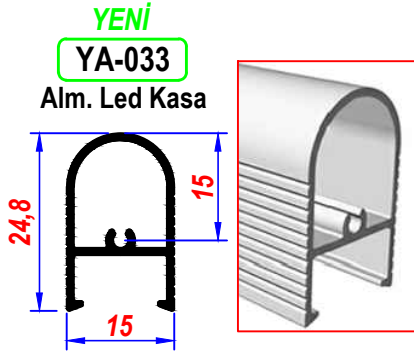

MONTAJ

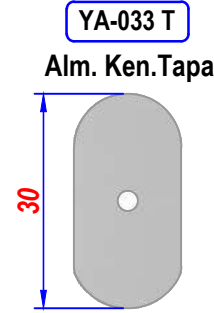
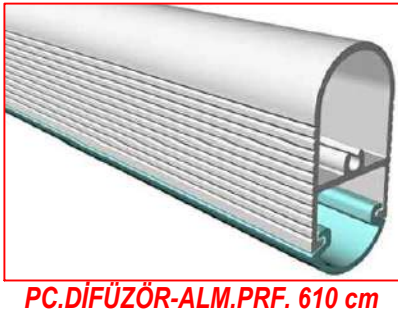

LED AYDINLATMALI, SENSÖRLÜ IŞIKLI ASKI SİSTEMİ (BİTMİŞ ÜRÜN)

RDM 97-40 IŞIKLI ASKI BORUSU-PİLLİ 40 cm

RDM 97-60 IŞIKLI ASKI BORUSU-PİLLİ 60 cm

RDM 97-80 IŞIKLI ASKI BORUSU-PİLLİ 80 cm

RDM 97-100 IŞIKLI ASKI BORUSU-PİLLİ 100 cm

RDM 97-120 IŞIKLI ASKI BORUSU-PİLLİ 120 cm

RDM 97-140 IŞIKLI ASKI BORUSU-PİLLİ 140 cm



PİLLİ IŞIKLI ASKI BORUSU - ÖZEL ÖLÇÜLER İÇİN ARAYINIZ!



- * Ledli aydınlatma sistemleri, sıradan aydınlatma sistemlerine göre da iyi aydınlatma sağlar ve uzun yıllar parlaklıklarını korur.
- * Bu özelliklerinden dolayı sıradan aydınlatma sistemlerine göre, çok fazla enerji tasarrufu sağlamaktadırlar.
- * İçinde bulunan harekete duyarlı sensör sayesinde kapak açıldığında (hareketi algıladığında) ışık yanar.Kapak kapatıldığında, 30 saniye sonra ışık kendiliğinden söner.
- * Elektrik bağlantısı istemeyenler için, pilli aydınlatma ideal çözümdür.

İstenilen ölçülerde kesim yapılır - İstenilen renge boyanır
All cutting dimensions and surface coatings can be done according to requirements

DEKORATİF BOMBELİ SIVA ÜSTÜ LED PROFİL VE AKSESUARLARI

YA-1006

Alm.Led Kasa

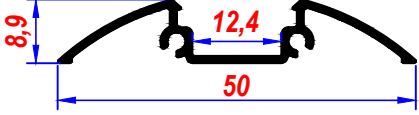

12 mm lik PCB ve Şerit lede uygun
Çift taraflı bant ile,kolay nontaj

YA-1006 Alm. YA-001 E PC.

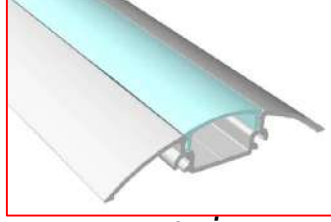

ALM.PRF. - PC.DİF. 610 cm

YA-1006 E1

Alm. Kenar Tapa



YA-001 E PC ye UYGUN

YA-001 C

Düz P.C.Difüzör



Opal-Şeffaf

YA-001 E

Düş.Bom.P.C.Difüzör

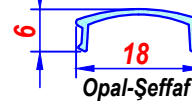

Opal-Şeffaf

YA-001 C

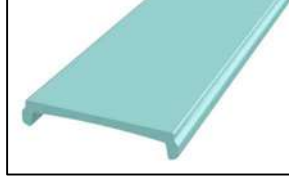

YA-001 E



PC.DİFÜZÖR-ALM.PRF. 610 cm

YA-1006 Alm.Prf.

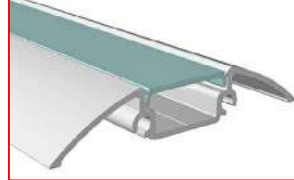

YA-001 C - PC DİFÜZÖR

YA-1006 Alm.Prf.

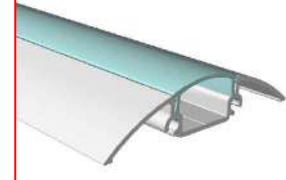

YA-001 E - PC DİFÜZÖR

YA-1005

Alm.Led Kasa

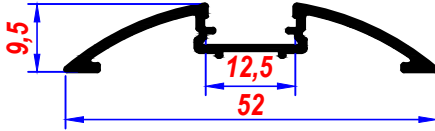

12 mm lik PCB ye uygun

YA-002 A

P.C. Difüzör



Opal - Şeffaf

YA-1005 T

Alm. Kenar Tapa

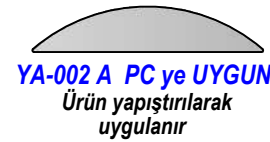

YA-002 A PC ye UYGUN
Ürün yapıştırılarak uygulanır

YA-1005 A

Alm.Duvar
Bağlt. Prf.

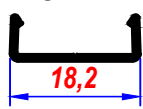

MONTAJ 1/1

YA-1005

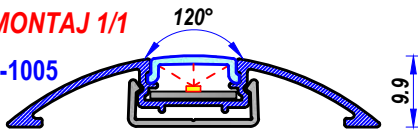

YA-1005 A

12 mm lik PCB uygun
Dekoratif Siva Üstü Led Profili
Kullanım alanları; Mobilya,
Mutfak, Zemin, Duvar vb.

YA-002 A



YA-1005 A

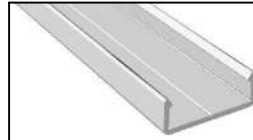

YA-1005 YA-002 A YA-1005 A



PC.DİFÜZÖR-ALM.PRF. 610 cm

İstenilen ölçülerde kesim yapılır - İstenilen renge boyanır

All cutting dimensions and surface coatings can be done according to requirements

YA-057

Alm.Led Kasa
Sabit kızaklı

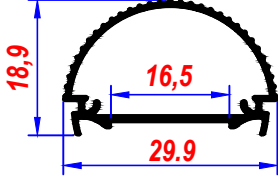

YA-057

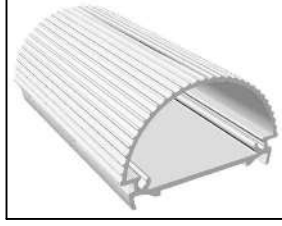

ALM. PRF. 610 cm

YA-058

Alm.Led Kasa
Hareketli Kızaklı

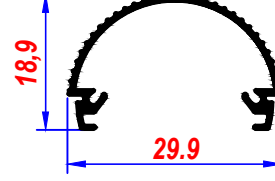

YA-058

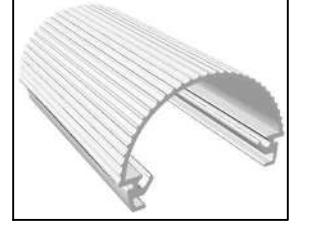

ALM. PRF. 610 cm

YA-057 A

P.C. Cam

27,4

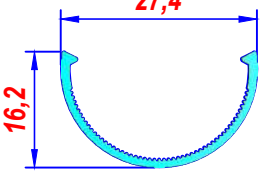

YA-057 A



P.C. DİFÜZÖR 610 cm

YA-058 A

Alm.Kızak Prf.

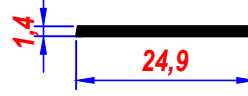

YA-058 B

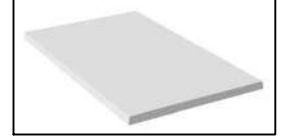

ALM. PRF. 610 cm

YA-057 / YA-058 UYUMLU
Opal - Şeffaf

LINEER KUULLANIMA UYGUN ÜRÜN

YA-057 B

PBT Kenar Tapa

Faturalı

RENK ; Beyaz



YA-057 C

PBT Kenar Tapa

Faturasız

RENK ; Beyaz



YA-057 T

ALM. Kenar Tapa

RENK ; A.Gri

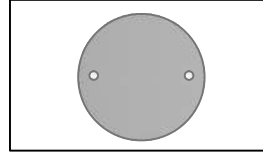

YA-057 / YA-058 UYUMLU YA-057 / YA-058 UYUMLU YA-057 / YA-058 UYUMLU

YA-057 D

Floresan tavan Bağlantı
Aparatı (PVC)

RENK : Beyaz

YA-058

YA-058 A

YA-057 A



YA-057 / YA-058 UYUMLU

P.C.PRF. - ALM. PRF. 610 cm

YA-057

YA-057 A

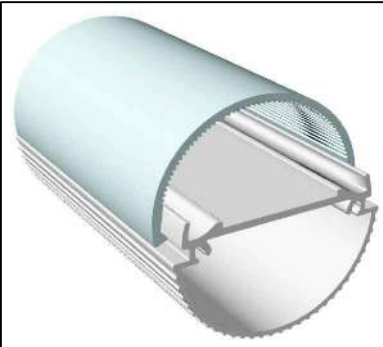

PC.DİFÜZÖR-ALM.PRF. 610 cm

YA-057

YA-057 A

YA-057 B



P.C.PRF. - ALM. PRF. 610 cm
60 ve 120 cm lik takım halinde,
farklı ölçü ve uzunluklarda kesilir

YA-058

YA-057 A

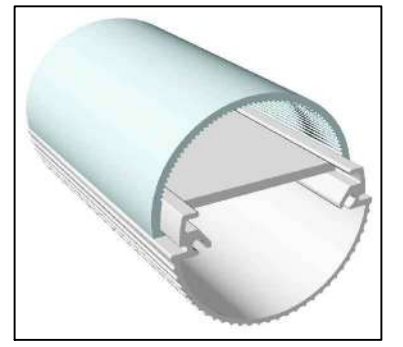

PC.DİFÜZÖR-ALM.PRF. 610 cm

İstenilen ölçülerde kesim yapılır - İstenilen renge boyanır
All cutting dimensions and surface coatings can be done according to requirements

YA-061

Alm.Led Kasa

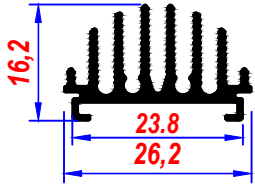

YA-061 A

Pl. Tapa (Contasız)



YA-045 B

Oval P.C.Difüzör

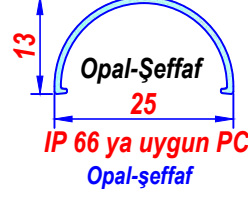

MONTAJ



YA-062

Alm.Led Kasa

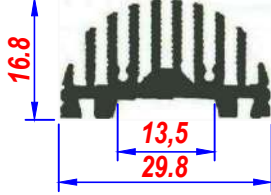

YA-062 MONTAJ



Kuyumcu aydınlatmalarına uygun

YA-062 A

Pl. Tapa (Contasız)



YA-063

Alm.Led Kasa

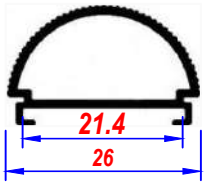

YA-063



ALM. PRF. 610 cm

YA-063 A

Pl. Tapa (Contasız)



YA-061 B

PC. Difüzör



MONTAJ



YA 061-YA 063-YA 200 Uyumlu

YD-001

Alm. LG Panel Kasası
RENK : Eloksal

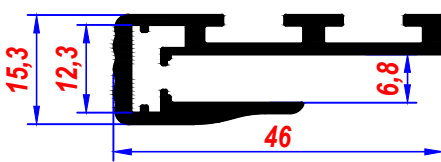

YD-001 A

Alm. Prf.



YD-001 A

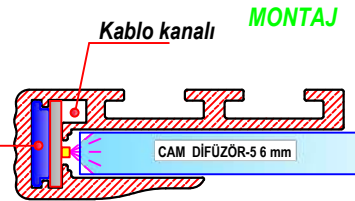

MONTAJ

YD-001

MONTAJ



YD-002

Alm. LG Panel Kasası

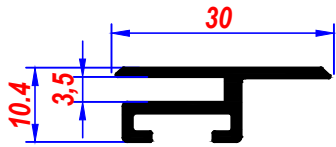

MONTAJ

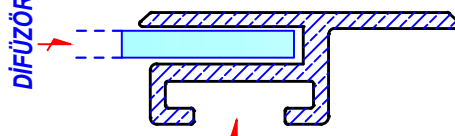

45°gönye kesim köşe
birleştirme yuvası

YD-002

MONTAJ



YD-006

Alm. LG Panel Kasası

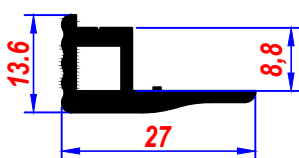

MONTAJ

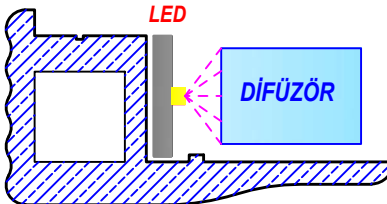

YD-006

MONTAJ



İstenilen ölçülerde kesim yapılır - İstenilen renge boyanır
All cutting dimensions and surface coatings can be done according to requirements

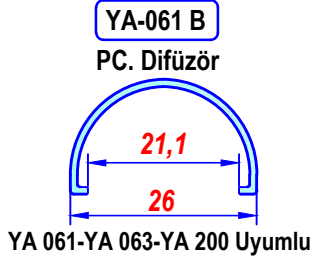
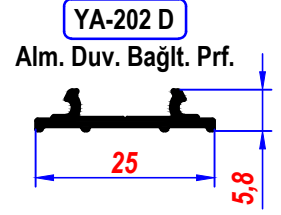
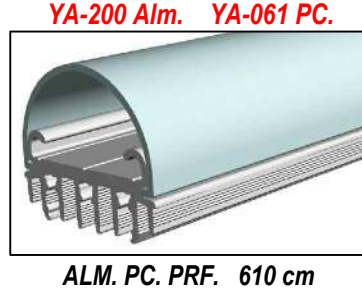
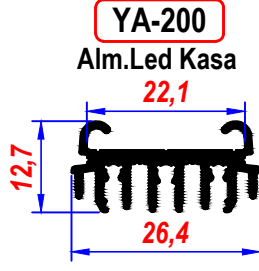

Benzerlerinden daha fazla fonksiyonel
Üç farklı cam seçeneği
Üç farklı lazer kenar tapa seçeneği
Soğutma kapasitesi yüksek, ekonomik ürün

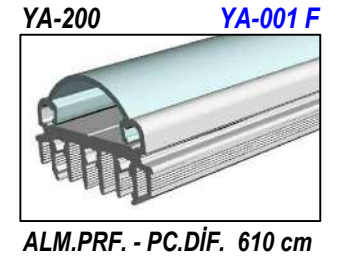
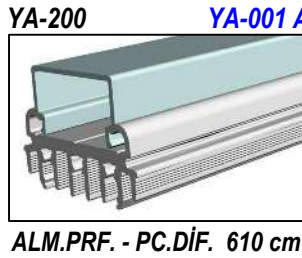
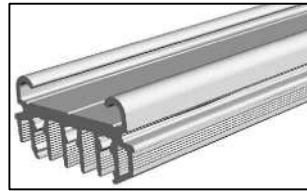
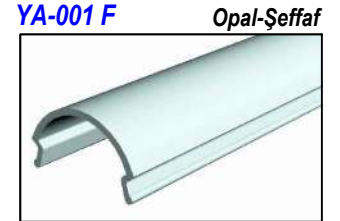
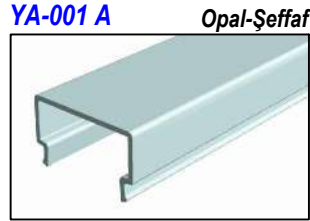
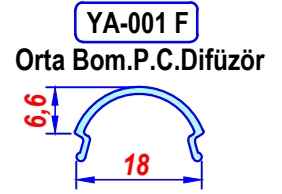
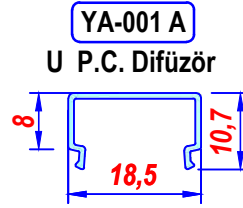

ALM.PRF. - PC. CAM
UYGULAMA
YA-061 B, YA-001 A, YA-001 F

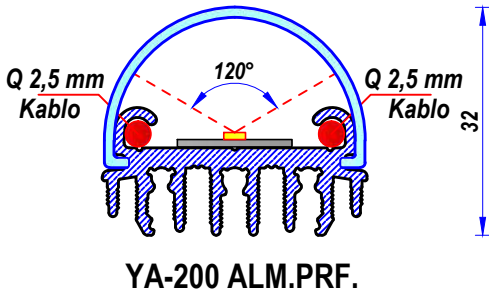

YA-200 ALM.PRF. VE AKSESUARLARI

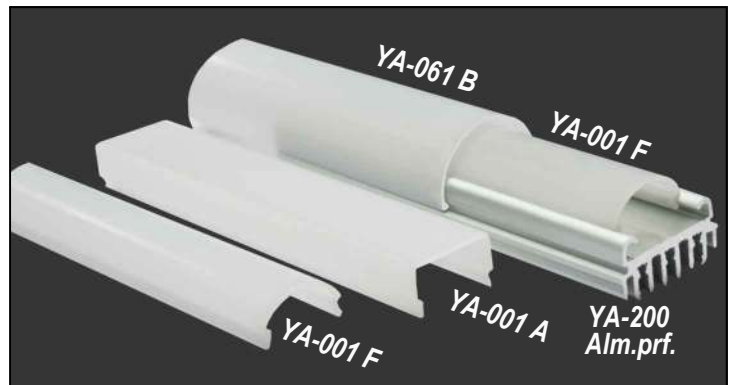

İstenilen ölçülerde kesim yapılır - İstenilen renge boyanır
All cutting dimensions and surface coatings can be done according to requirements

AKVARYUM AYDINLATMA PROFİLLERİ

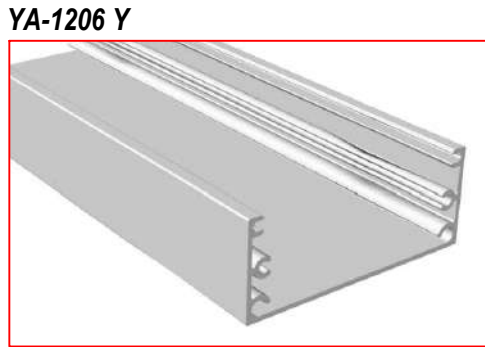
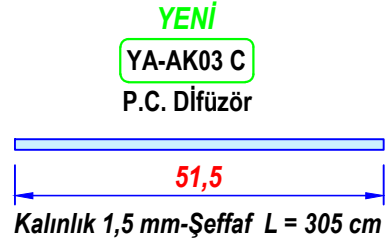
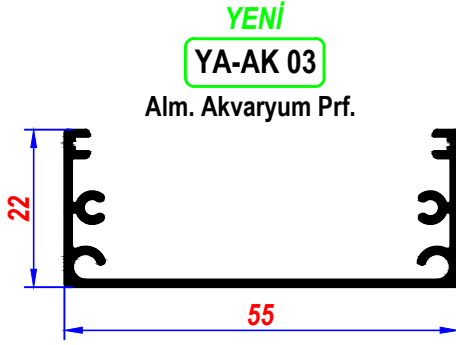

ALÜMİNYUM PROFİL 610 cm

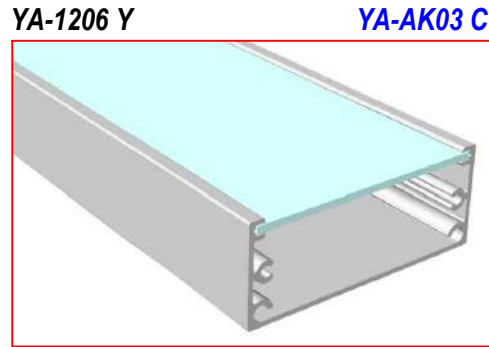

ŞEFFAF DİFÜZÖR - 305 cm

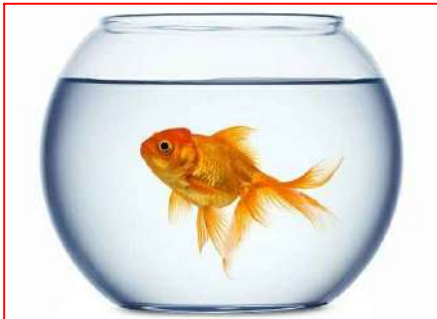
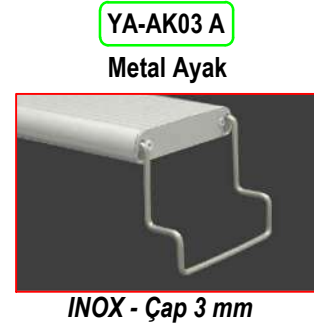
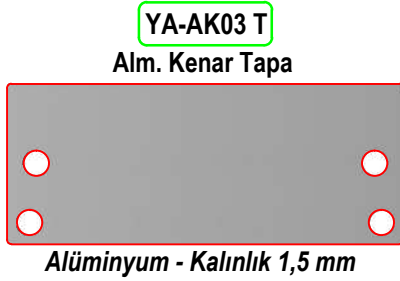

AKVARYUM AYDINLATMA PROFİLLERİ

YA-AK 01

Alm. Akvaryum Prf.
KÜÇÜK KASA

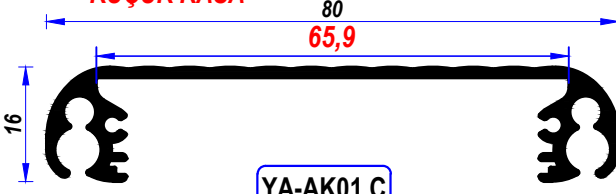

YA-AK01 C
P.C. DİFÜZÖR



YA-AK01 C PC.PRF.

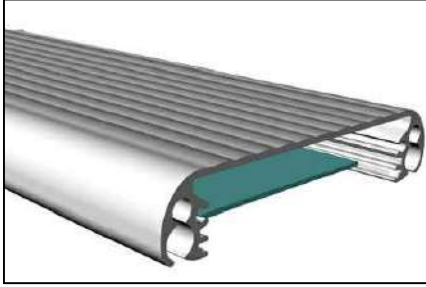

ALU.PRF. - PC. PRF 610 mm

YA-AK01 T

Alm. Kenar Tapa



YA-001 S
ON-OFF Switch



Kenar Tapada Kullanılır

YA-AK01 A

Metal Ayak
Çap 3 mm



YA-AK01 T1
Kenar Tapa



YA-AK01 T2
Kenar Tapa



L LAZER TAPA - ALM.

AKVARYUM AYDINLATMA



YA-AK 02

Alm. Akvaryum Prf.
BÜYÜK KASA

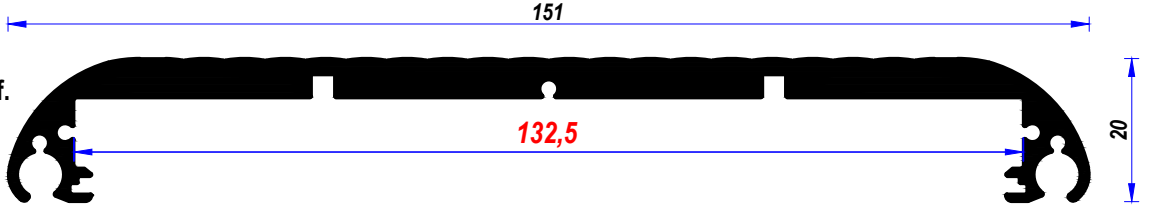

YA-AK02 C

Akrilik DİFÜZÖR

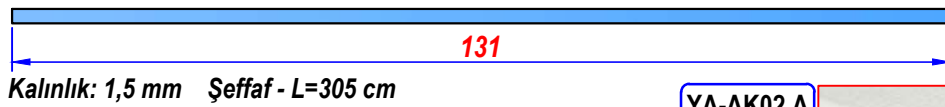

YA-AK02 T

Kenar Tapa
Alm.Lazer



YA-AK02 A

Metal Ayak
Çap 4 mm



YA-001 S

ON-OFF Switch



Kenar Tapada Kullanılır

ALM.PRF. - PC. PRF 610 mm



YA-AK02 T1

Kenar Tapa



YA-AK02 T2

Kenar Tapa



L LAZER TAPA - ALM.

LEDLİ SÜPÜRGELİK PROFİL VE AKSESUARLARI

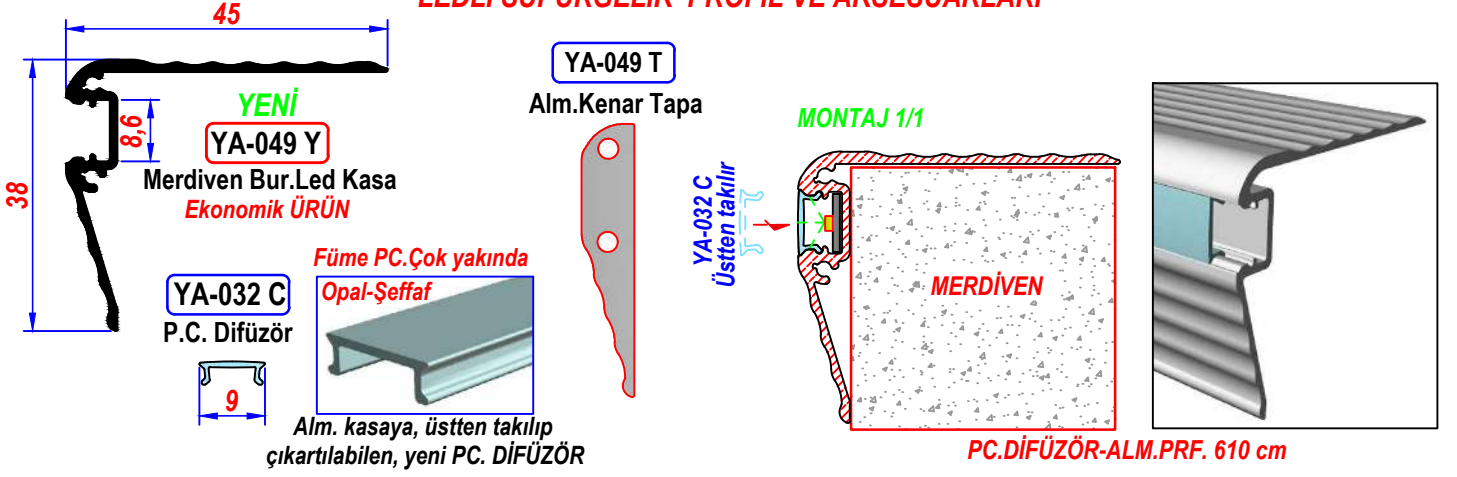

LEDLİ SÜPÜRGELİK PROFİL VE AKSESUARLARI

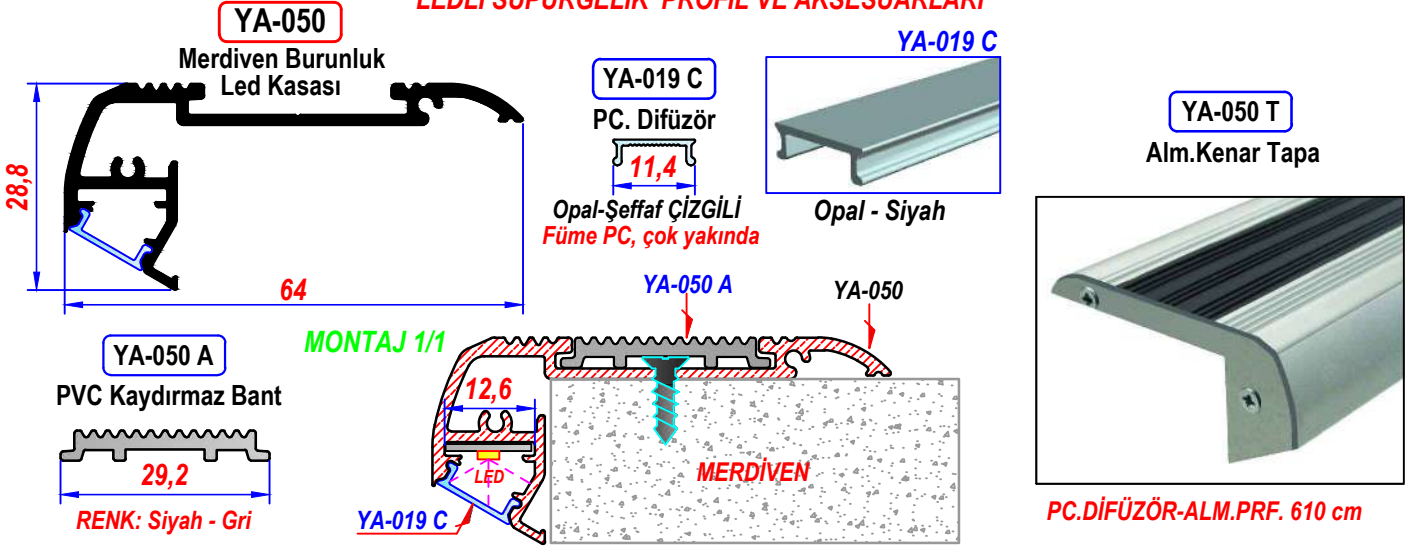

YENİ YA-055
Alm.Led Kasa

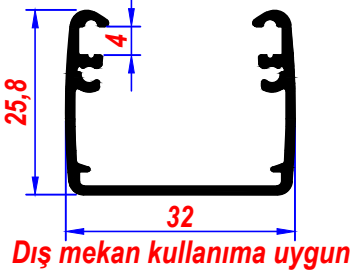

YA-055 A
Pls.Tapa - Conta



YA-055 B
Alm. Kenar Tapa



YA-055 C
Alm. Kenar Tapa



YA-LS 1
Polikarbon Lens



**LENS; Ayrıca,duvar boyama,
projektor ve sokak armatür
kasalarında kullanıma uygundur**

YA-055 ALM. LED KASA VE AKSESUARLARI



**Trafik araçlarında, acil durum uyarı sistemlerinde,
Lineer aydınlatmalarda kullanıma uygundur**

İstenilen ölçülerde kesim yapılır - İstenilen renge boyanır

All cutting dimensions and surface coatings can be done according to requirements

LEDLİ SÜPÜRGELİK PROFİL VE AKSESUARLARI

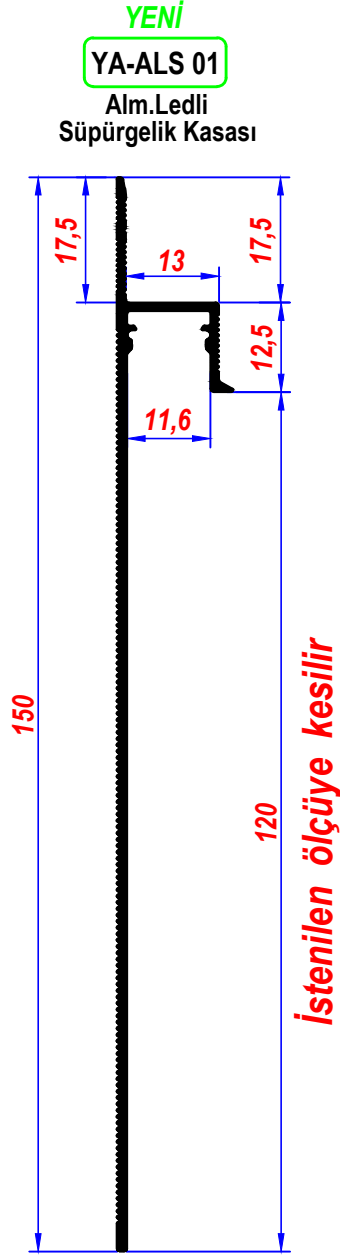

YA-019 C

PC. Difüzör



Füme PC, çok yakında

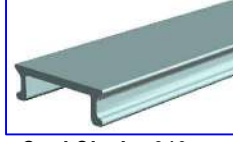

Opal-Siyah - 610 cm

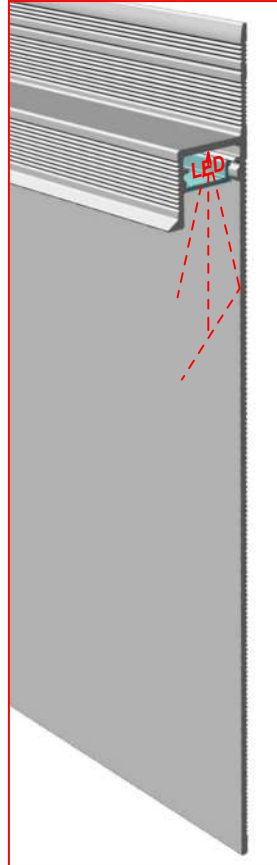

UYGULAMA

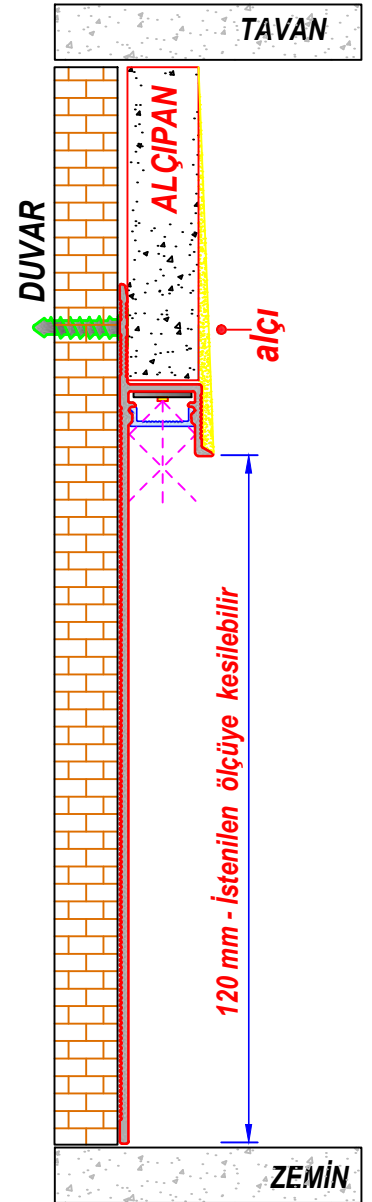

PC.DİFÜZÖR-ALM.PRF. 610 cm Alt uzunluk, istenilen boyda kesilebilir

KABLO KANALI PROFİLLERİ

YA-098 A

Kablo Kanalı Alm.Pr.f.

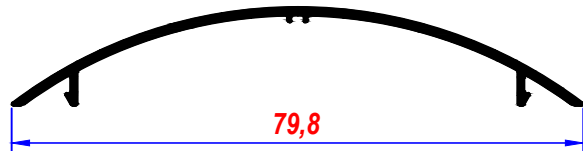

YA-098

Kablo Kanalı Alm.Pr.f.

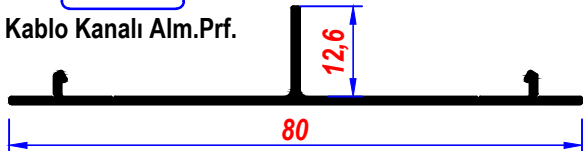

ALÜMİNYUM PROFİLLER 610 cm

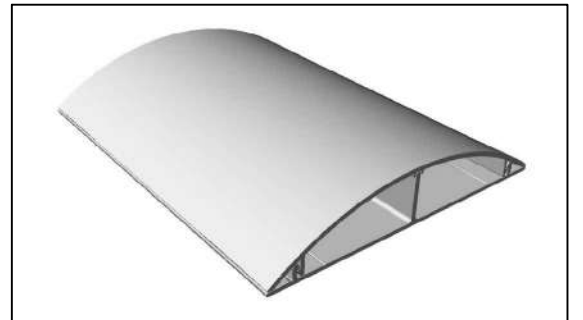

İstenilen ölçülerde kesim yapılır - İstenilen renge boyanır
All cutting dimensions and surface coatings can be done according to requirements

İÇ MEKAN, LEDLİ SÜPÜRGELİK PROFİL VE AKSESUARLARI

YENİ
YA-091 Y
Alm.Ledli Süpürgelik Kasası

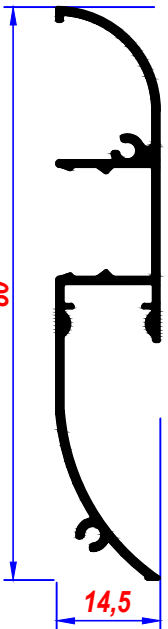

80
14,5

YENİ
MD-457
Alm. Köşe Dönüş Prf.

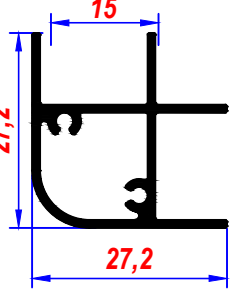

15
27,2
27,2

MD-457
ALM.PROF. 610 cm

YENİ
MD-457 T
Alm. Kenar Tapa

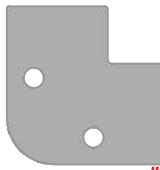

YENİ
MD-457 T1
Alm. Kenar Tapa



ALÜMİNYUM-LAZER

YENİ
YA-091 Y

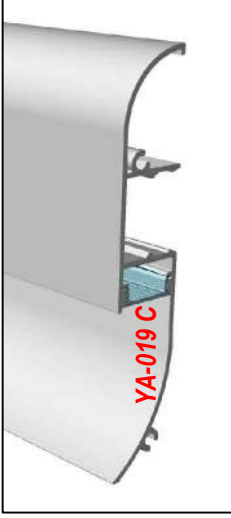

PC.DİFÜZÖR
ALM.PROF. 610 cm

YENİ
YA-023 B
Alm.Montaj Prf.

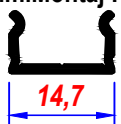

14,7

YENİ
YA-019 C
PC. Difüzör



11,4

Opal-Şeffaf
Siyah PC.Çok yakında

YENİ
YA-091 T
Alm. Kenar Tapa



MONTAJ 1/1

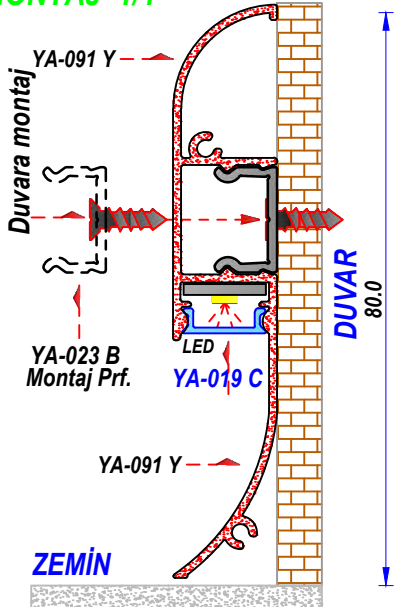

Duvara montaj
YA-091 Y
YA-023 B Montaj Prf.
LED
YA-019 C
YA-091 Y
ZEMİN
DUVAR 80,0

İÇ MEKAN, LEDLİ SÜPÜRGELİK PROFİL VE AKSESUARLARI

YA-090
Alm.Ledli Süpürgelik Kasası

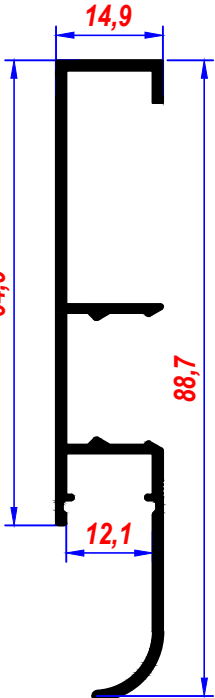

14,9
64,9
88,7
12,1

YA-002 A
PC. Difüzör



12,8

Opal - Şeffaf

YA-090 A
PVC U Duv. Montaj Prf.

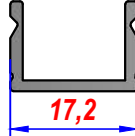

17,2

YA-090
PVC PRF.300 cm

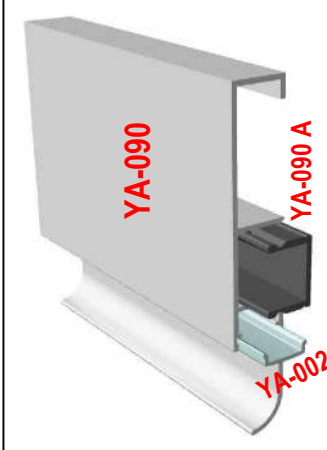

YA-090 A
YA-002 A

PC.DİFÜZÖR-ALM.PROF. 610 cm

MONTAJ

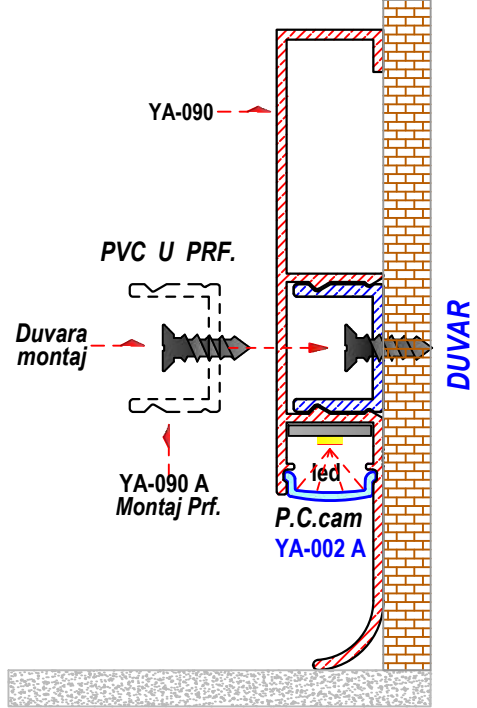

Duvara montaj
YA-090
PVC U PRF.
YA-090 A Montaj Prf.
led
P.C.cam
YA-002 A
ZEMİN
DUVAR

İstenilen ölçülerde kesim yapılır - İstenilen renge boyanır
All cutting dimensions and surface coatings can be done according to requirements

LEDLİ SÜPÜRGELİK VE BAZA PROFİLİ

YA-092
Alm.Ledli
Süpürgelik-Baza
Profili

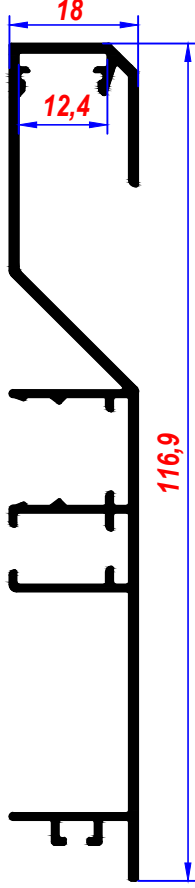

MD-445

Alm.Köşe Dönüş Prf.

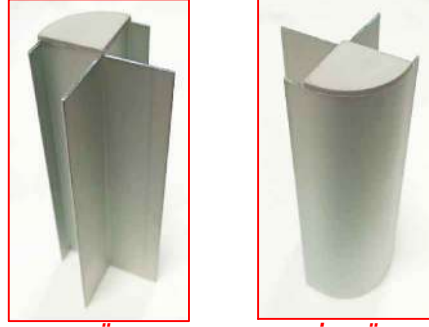

DIŞ KÖŞE
İÇ KÖŞE
YA-092 İÇ - DIŞ KÖŞE UYGULAMASI



Bu ürün, Ledli süpürgelik ve ledli baza olarak da kullanılabilir

YA-019 C

PC.Cam-Difüzör

11,4

Opal, Şeffaf-ÇİZGİLİ

Füme PC, çok yakında

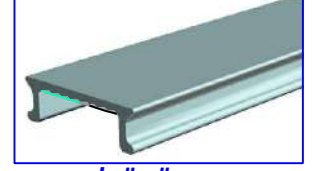

PC DİFÜZÖR 610 cm

BZ-001

Pls.Baza Klipsi



BF-101

Alm.Montaj Prf.



YA-023 B

Alm.Montaj Prf.

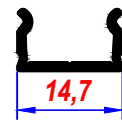

SÜPÜRGELİK - BAZA
UYGULAMASI

P.C.cam
YA-019 C

MONTAJ

Duvara
montaj

YA-023 B
Montaj Prf.

Baza Fitili
BF-101

ZEMİN

DUVAR-MOBİL YA

YA-092

YA-019 C

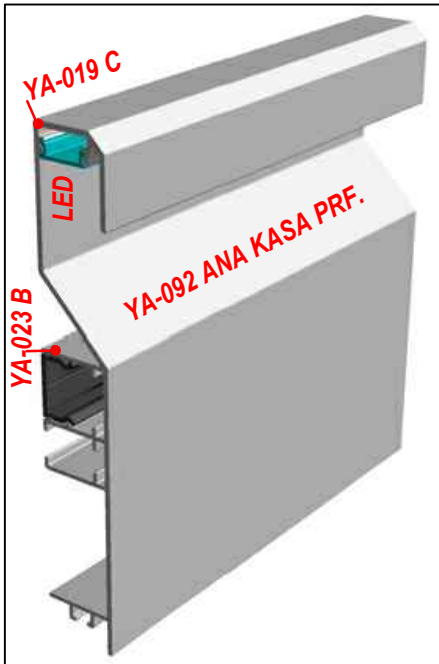

ALM.PRF. - PC. PRF 610 mm

İstenilen ölçülerde kesim yapılır - İstenilen renge boyanır
All cutting dimensions and surface coatings can be done according to requirements

ARAÇ AYDINLATMA PROFİL VE AKSESUARLARI

YA-093
Alm.Led Kasa

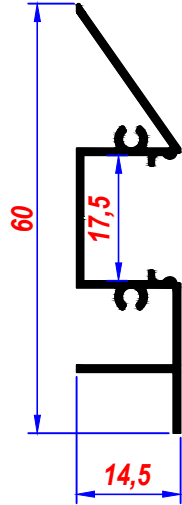

16 mm lik PCB uygun

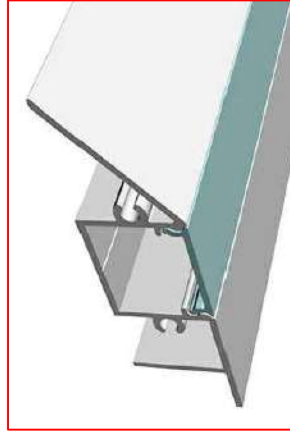

YA-093 Alm. Profil

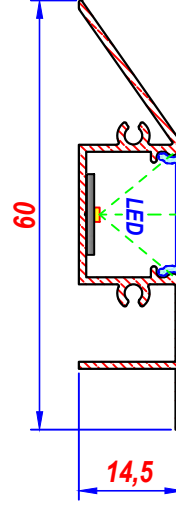

YA-093 T
Alm.Kenar Tapa



YA-1002 A
P.C. Difüzör
Opal - Şeffaf

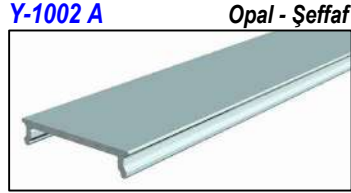

P.C.FİZÜZÖR 610 cm

Kullanım alanları;
Araç içi aydınlatma ve ledli süpürgelik

YA-094
Alm.Led Kasa

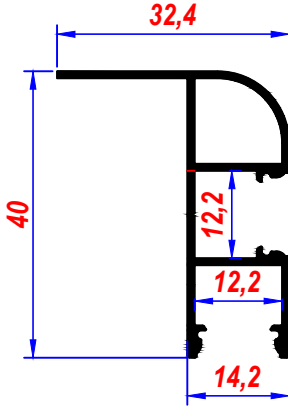

12 mm lik PCB ve Şerit lede uygun

YA-094 Alm. Profil

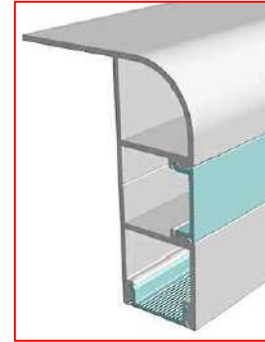

Kullanım alanları;
Araç içi ve basamak aydınlatma

MONTAJ 1/1 Çift yönlü LED Aydınlatma

YA-019 C
PC.Cam-Difüzör

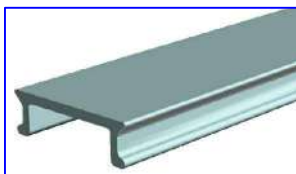

YA-019 C Opal - Şeffaf

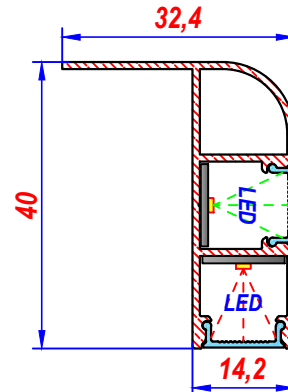

İstenilen ölçülerde kesim yapılır - İstenilen renge boyanır
All cutting dimensions and surface coatings can be done according to requirements

LIGHT BOX PROFİLİ

YA-LB 01

Light Box Prföfili

45 mm lik

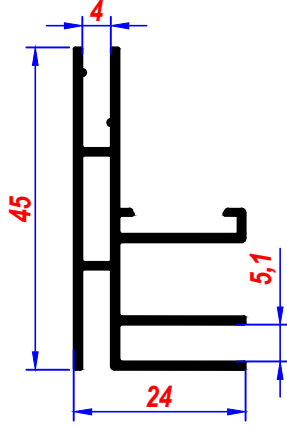

Sökölüp takılabilen özel baskılı vinil bez sayesinde, reklam deęiřtięinde kasa deęiřmez
İřçilięi daha kolay, aydınlatması daha iyi olan, yeni ekonomik alüminyum profil...

YA-LB 01

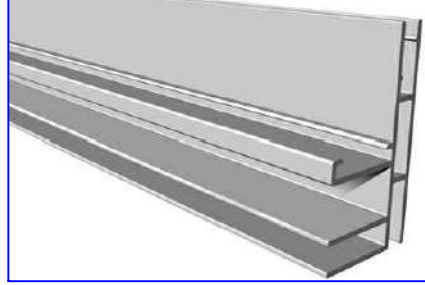

ALÜMİNYUM PRF. 610 cm

YA-207 E1

90° Köře Birleřtirme



16 mm

Özel Baskı
VİNİL BEZ

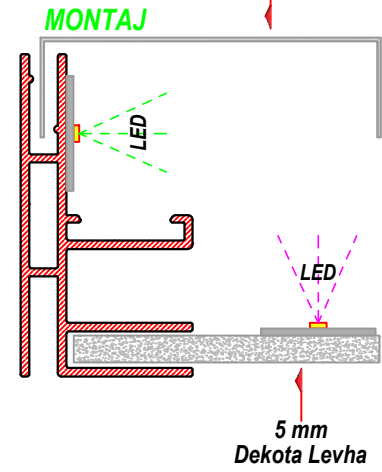

3 FARKLI LIGHT BOX UYGULAMASI



YA-MK 01

Ledli Alm.Korkuluk Prf.

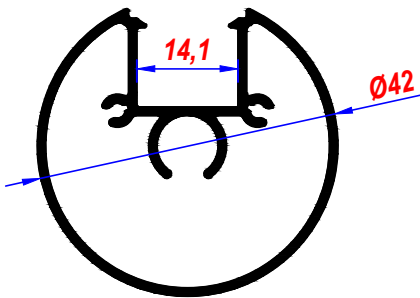

ÇOK AMAÇLI LEDLİ YUVARLAK PROFİLİ

AVZ-001 P

PC Cam-Difüzör

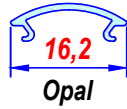

ALÜMİNYUM KORKULUK PROFİLİ,
Yuvarlak ledli lineer sarkıt aydınlatma,
ve Mobilyalarda ledli ayak olarak da
kullanıma uygundur...

YA-MK01 T

Kulaklı / Kulaksız Kenar Tapa

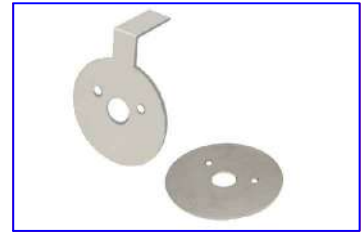

Alm. - Lazer

MERDİVEN KORKULUK UYGULAMASI

2 FARKLI LİNEER SARKIT UYGULAMASI

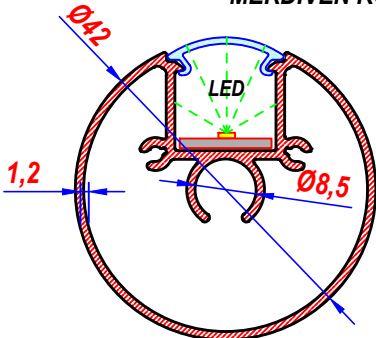

İstenilen ölçülerde kesim yapılır - İstenilen renge boyanır
All cutting dimensions and surface coatings can be done according to requirements

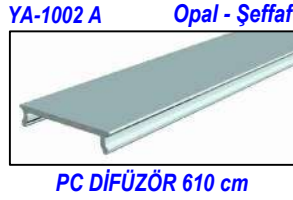
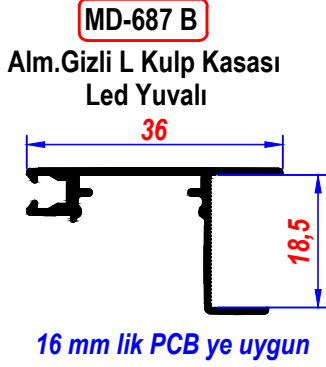

Hem gizli kulp, hemde ledli aydınlatma görevi görür

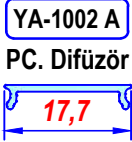
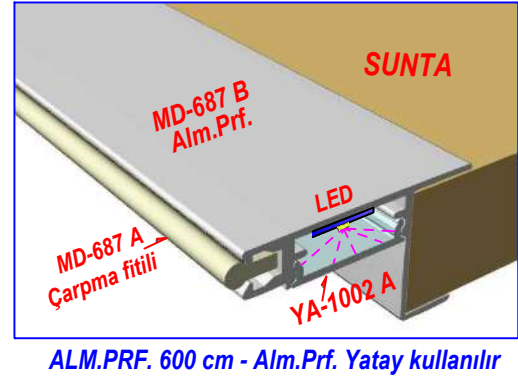

- * Mutfaklarda, tezgah üstü, tezgah duvarı, tezgah altı (baza) aydınlatmalarında,
- * Otel dekorasyonunda, yatak başı ve yarım lambiri aydınlatmalarında,
- * Otel dekorasyonunda, yatak başı ve yarım lambiri aydınlatmalarında
- * 18 mm suntaya geçme sistemi ile kolay montaj yapılabilir.

TEZGAH ÜSTÜ DOLABI BÜYÜTÜLMÜŞ DETAY

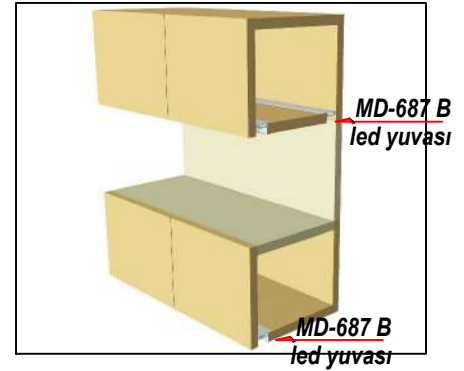
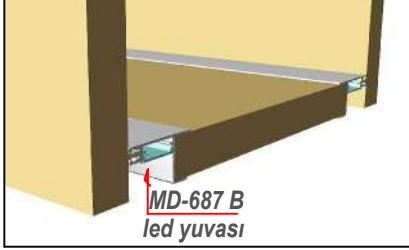

MONTAJ
YAN KESİT

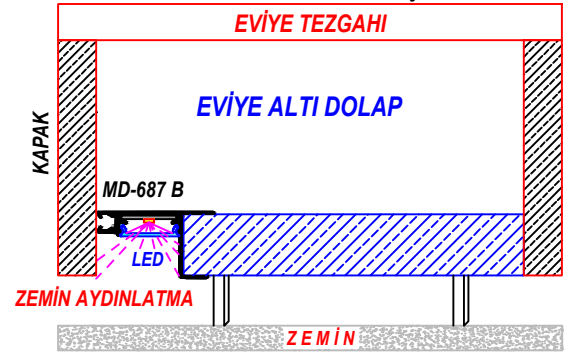
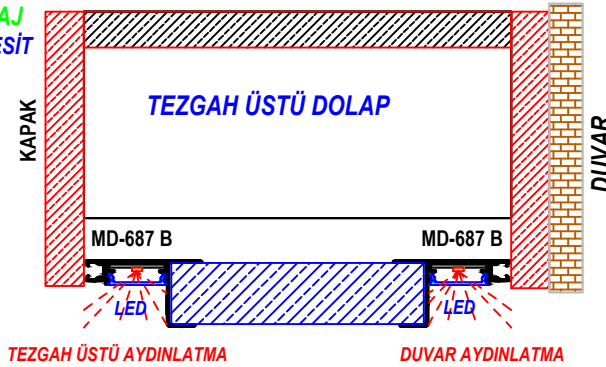

LEDLİ ÇERÇEVE PROFİLİ

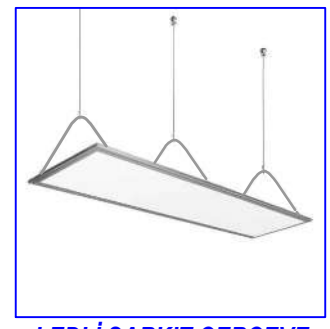
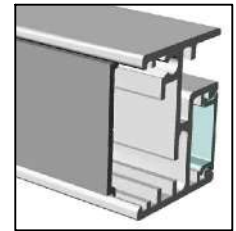
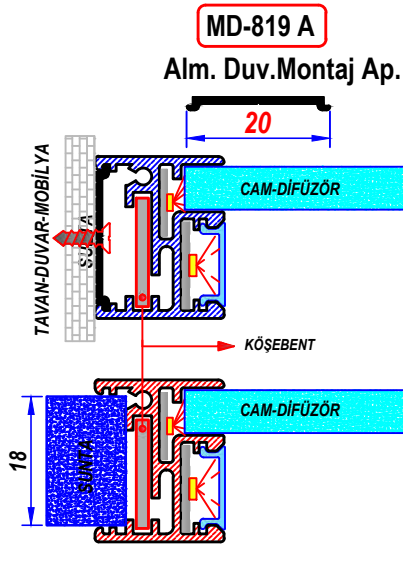
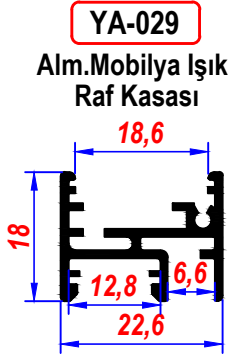

LEDLİ, GİZLİ KULP PROFİL VE AKSESUARLARI

MD-688 LD

Ledli Gizli Kulp
Alm. Prf.

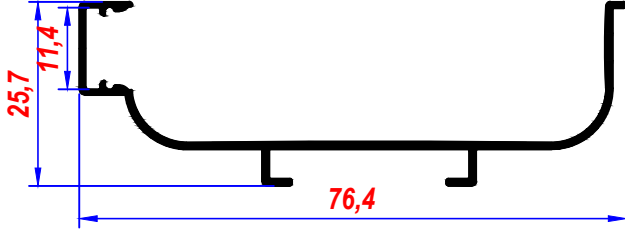

YA-019 C

PC. Difüzör

11,4

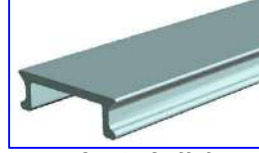

Opal - Şeffaf

MD-686 A

Mouting Apparatus



Plastik - Açık Gri

Mutfak tezgahı alt dolap kapaklarında kullanılır.
Kulp detayı gözükmez. Ledli versiyonu,
mutfağınıza değer katar. Kulbun yerini belirler,
kapağı açtığınızda dolabın içini aydınlatır.

ALM.PRF.-PC. PRF 610 mm

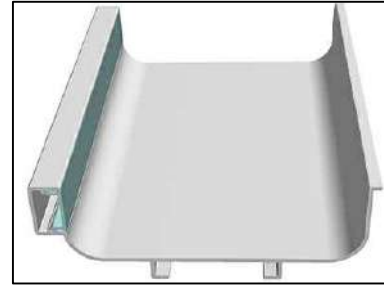

DİŞ MEKAN IP 66 ya, UYGUN ÇİZGİSEL AYDINLATMA PRF-AKSESUARLARI

YA - 150

Alm.Led Kasa

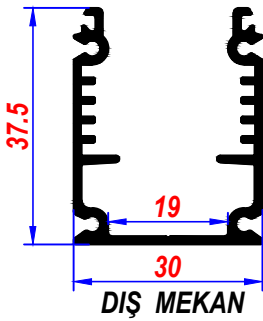

DİŞ MEKAN

YA-150 A

Alm.Duvar Montaj Prf.

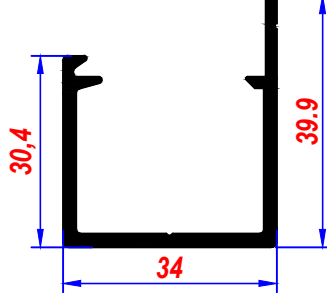

YA-150 B

Alm. İç Kızak Prf.

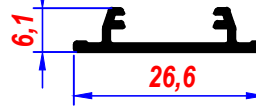

YA-150 C

PC. U Difüzör

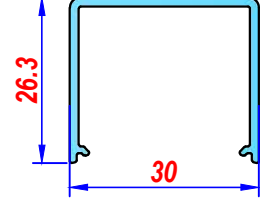

Yazılım kumandalı, temalı aydınlatma sistemlerine uygun
Programlanabilir, şov amaçlı cephe aydınlatmaları.
Enerji kablosu ve kumanda modülüne uygun, duvar profili.

DİŞ MEKAN ÇİZGİSEL AYDINLATMA UYGULAMASI



PC.DİFÜZÖR
ALM.PRF. 610 cm

MONTAJ

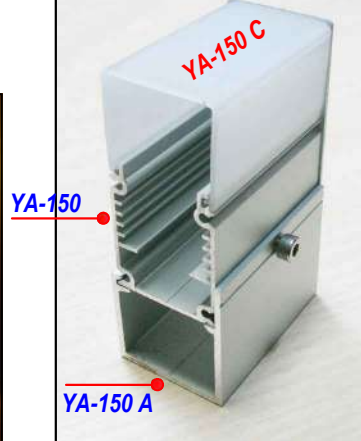

YA-150 T

Alm. Kenar Tapa

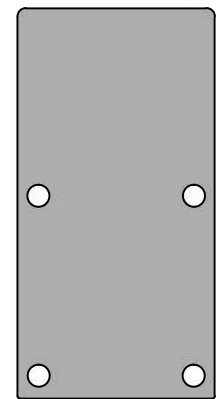

Lazer

İstenilen ölçülerde kesim yapılır - İstenilen renge boyanır
All cutting dimensions and surface coatings can be done according to requirements

POLİKARBON YUVARLAK BORU PROFİLLERİ - ALÜMİNYUM KAYNAK TELLERİ

YA - PB 40

Polikarbon Boru
Ø 40 mm-OPAL
Kalınlık:2 mm

YA - PB 50

Polikarbon Boru
Ø 60 mm-OPAL
Kalınlık:1.4 mm

YA - PB 60

Polikarbon Boru
Ø 59,5 mm-OPAL
Kalınlık:1.4 mm

YA - PB 70

Polikarbon Boru
Ø 70 mm-OPAL
Kalınlık:2 mm

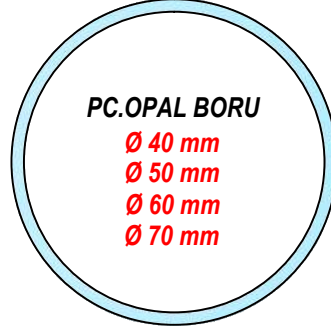

METAL KENAR TAPA

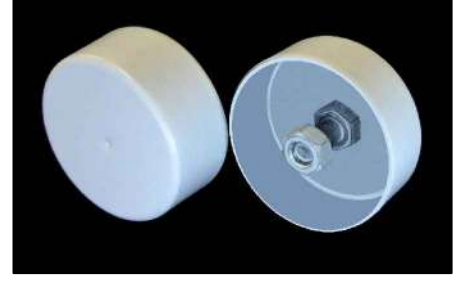

Sonlandırma ve Askı Tapaları

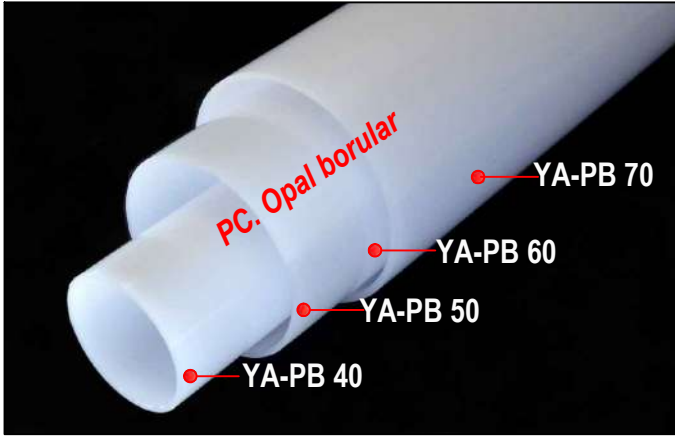

ALÜMİNYUM 5356 MİG-MAKARA KAYNAK TELİ

KALINLIK 1 - 1,2 mm



ALÜMİNYUM 5356 TİG-ÇUBUK KAYNAK TELİ

KALINLIK 2 - 2,4 mm



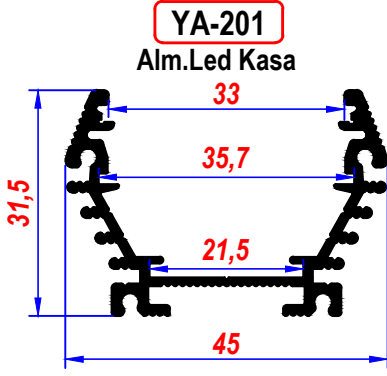

Benzerlerinden daha fazla fonksiyonel
Üç farklı PC.Difüzör ve iç kızak
Dört farklı kenar tapa seçeneği
Soğutma kapasitesi yüksek, ekonomik ürün

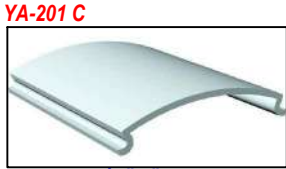
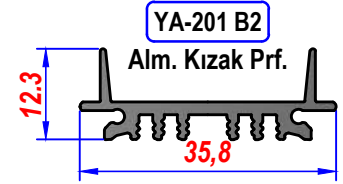
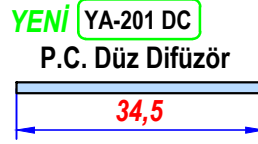
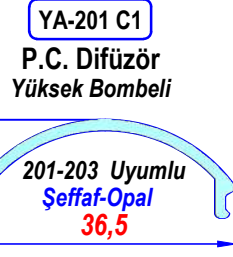
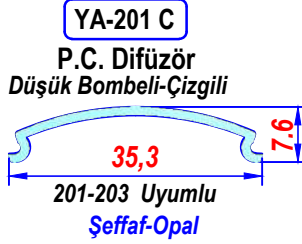
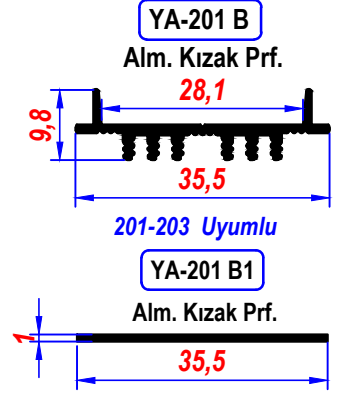

P.C.DİFÜZÖR 610 cm



P.C.DİFÜZÖR 610 cm



Inox Klips H = 12,5mm

MONTAJ YA 201 YA 201 C



YA 253 M Dekoratif minik ayak
Kasa 180° hareket ettirilebilir



Renk:A.Gri



YA-201 ALM.PR.F. VE AKSESUARLARI

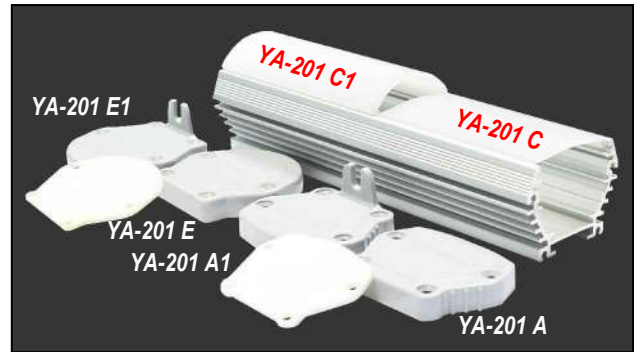

Alm.Pr.f.in Alt tırnağına ayak seti (YA 253 serisi) montaj
edilerek, açılı kullanabilme imkanı



Renk:A.Gri



KULAKLI

KULAKLI

MONTAJ YA-201 C

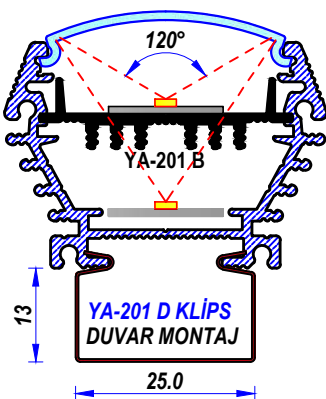

ALM. PR.F. VE PC. DİFÜZÖR UYGULAMALARI

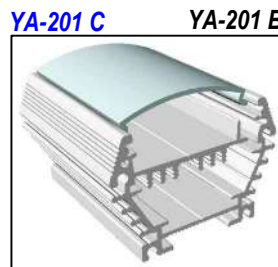

YA-201 B

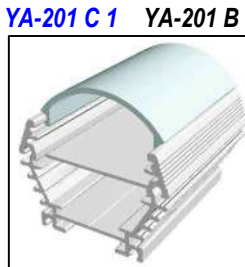

YA-201 B 1

PC.DİFÜZÖR - ALM.PR.F. 610 cm

MONTAJ

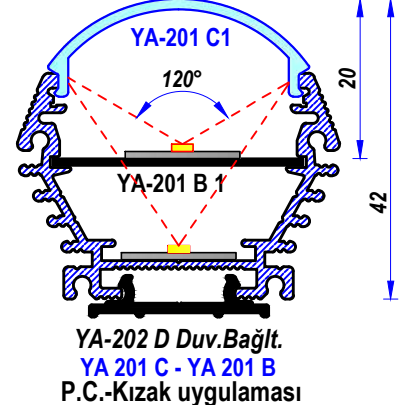

İstenilen ölçülerde kesim yapılır - İstenilen renge boyanır

YA-202

Alm.Led Kasa

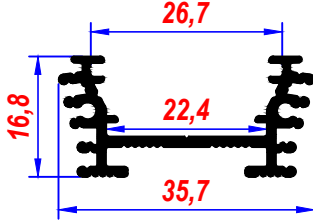

YA-202 ALM.PRF.

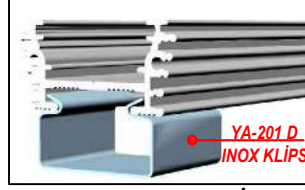

YA-201 D INOKS KLİPS

YA-201 D

Duvar Bağlt.Aprt.

H=12,5mm



Paslanmaz Klips

YA-202 A

Alm. İç Kızak Prf.



YA-202 D

Alm. Duv. Bağlt. Prf.



IP 65 e Uygun, İç-Dış Mekan Yeni Ürün

Tek-iki sıra led uygulanabilen, IP 65 e uygun,
İç-Dış Mekan Ürün. Dört farklı PC. Difüzör seçeneği
olan, Soğutma Kapasitesi yüksek ÜRÜN

YA-202 B

P.C. Difüzör



YA-016 B

P.C. Difüzör



YA-204 B

P.C. Difüzör

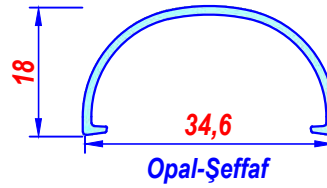

YA-204 C

P.C. Difüzör

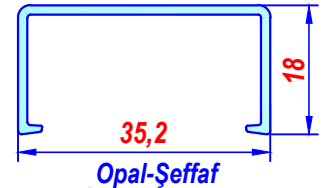

PC.DİFÜZÖR - ALM.PRF. ler 610 cm

IP 65 Uygun, 2 Farklı PC DİFÜZÖR

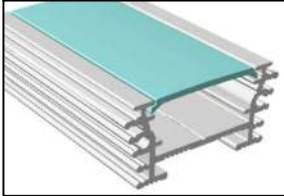

YA-202 B YA-202 ALM.PRF.

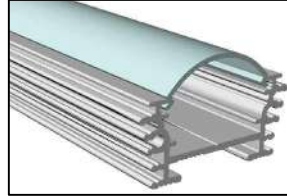

YA-202 B YA-202 ALM.PRF.

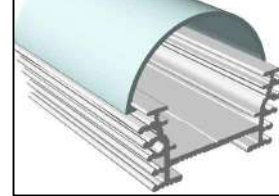

YA-204 B YA-202 ALM.PRF.

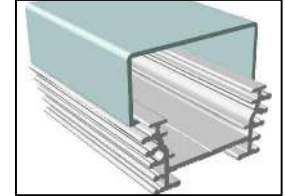

YA-204 C YA-202 ALM.PRF.

YA-202 F

Alm. Kenar Tapa

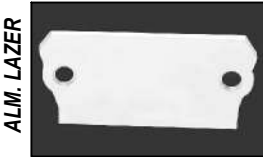

YA-202 C

Alm. Kenar Tapa

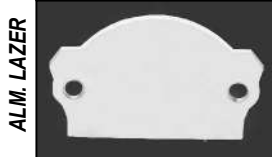

YA-202 G

Alm. Kenar Tapa



YA-202 E

Alm. Kenar Tapa



YA-202 F1

Alm. Kenar Tapa



YA-202 C1

Alm. Kenar Tapa



YA-202 G1

Alm. Kenar Tapa



YA-202 E 1

Alm. Kenar Tapa



4 FARKLI UYGULAMA ÖLÇEK 1/1

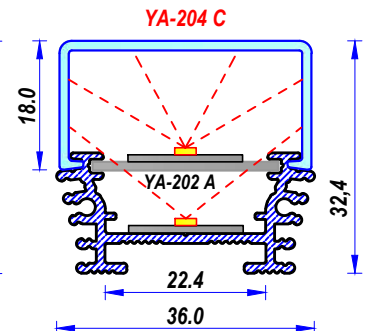
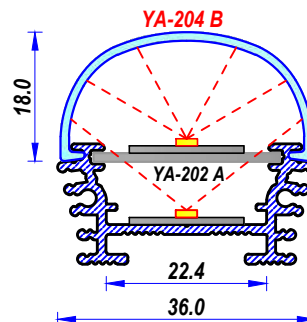
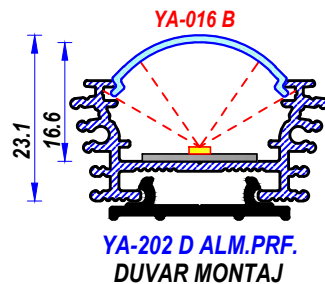
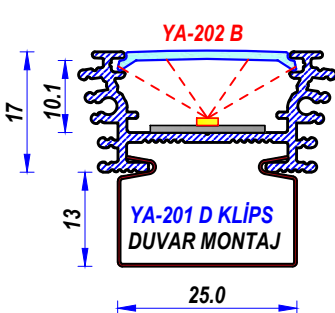

İstenilen ölçülerde kesim yapılır - İstenilen renge boyanır

YA-203

Alm.Led Kasa

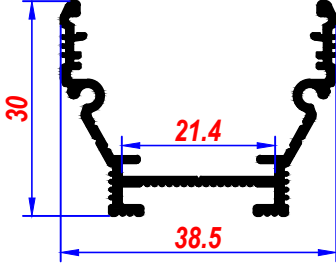

YA-203 YA-201 D INOKS KLİPS

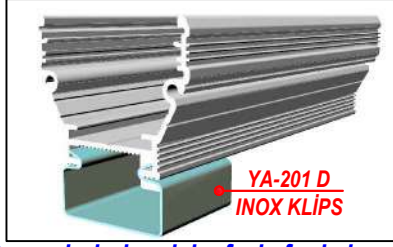

Benzerlerinden daha fazla fonksiyonel
Üç farklı cam ve iç kızak
Dört farklı kenar tapa seçeneği
Ekonomik ürün

YA-201 B

Alm. Kızak Prf.

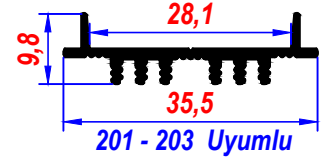

YA-201 B1

Alm. Kızak Prf.



YA-201 B2

Alm. Kızak Prf.

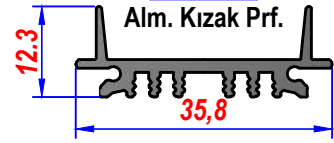

YA-201 C

P.C. Difüzör

Düşük Bombeli-Çizgili



YA-201 C1

P.C. Difüzör

Yüksek Bombeli



P.C.DİFÜZÖR ler 610 cm

YENİ YA-201 DC

P.C. Düz Difüzör



YA-202 D

Alm. Duv. Bağlt. Prf.

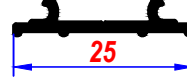

YA-201 D

Duvar Bağlt. Aprt.



Inox Klips H = 12,5mm

MONTAJ YA 203 YA 201 C 1



YA 253 M Dekoratif minik ayak

YA-203 A

P.C.Ken.Tapa-Conta

Düşük Bombeli



YA-203 B

P.C.Ken.Tapa-Conta

Yüksek Bombeli



RENK:Açık Gri
IP 66 TAPA

YA-203 A1

P.C.Ken.Tapa-Conta

Düşük Bombeli



YA-203 B1

P.C.Ken.Tapa-Conta

Yüksek Bombeli



RENK:Açık Gri
IP 66 TAPA

YA-203 ALM.LED KASA VE AKSESUARLARI

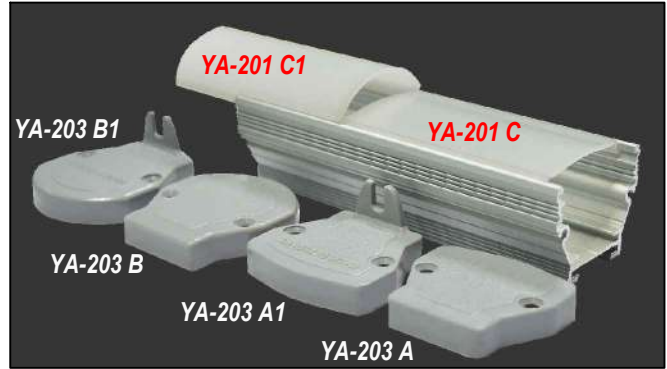

Alm.Prf.in Alt tırnağına ayak seti (YA 253 serisi) montaj edilerek, açılı kullanabilme imkanı

ALM. PRF. ve PC. CAM UYGULAMALARI

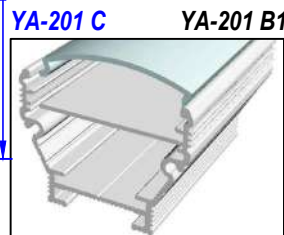
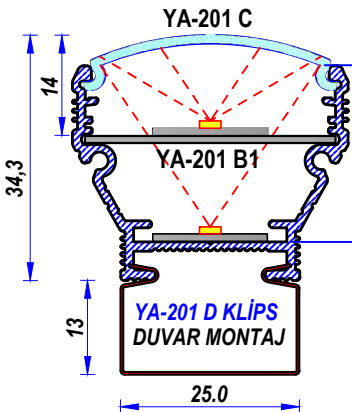

YA-201 C MONTAJ

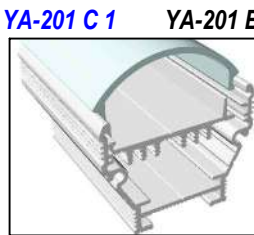

YA-201 C1 MONTAJ

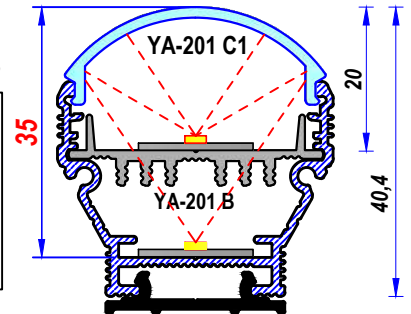

YA-202 D Duv.Bağlt.

YA 201 C - YA 201 B1

Cam-Kızak uygulaması

İstenilen ölçülerde kesim yapılır - İstenilen renge boyanır
All cutting dimensions and surface coatings can be done according to requirements

YA-204

Alm.Led Kasa

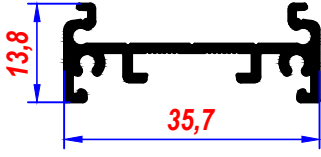

YA-204 A

Alm. Duvar Bağlantı Prf.

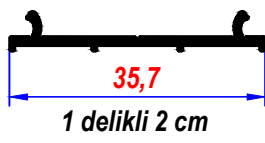

YENİ

YA-204 DB

Alm. Duvar Bağlantı Prf.

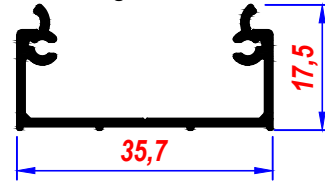

YENİ

YA-204 DÇ

Duvar Bağlnt.Aprt. Paslanmaz Klips

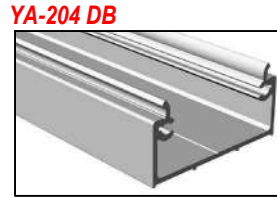
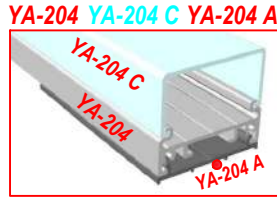
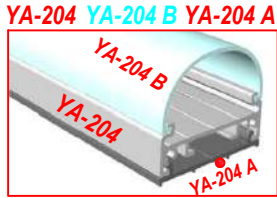
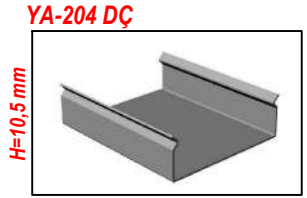

Alüminyum ve PC. Profiller 610 cm

Kablo kanalı gibi de kullanılır

YA-204 B

Oval P.C. Difüzör

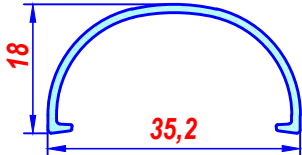

Opal-Şeffaf

YA-204 C

U P.C. Difüzör

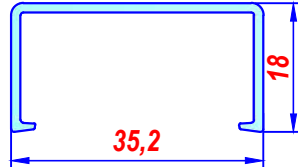

Opal-Şeffaf

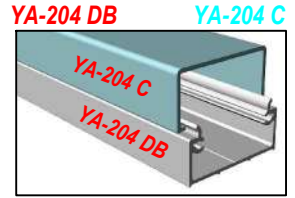
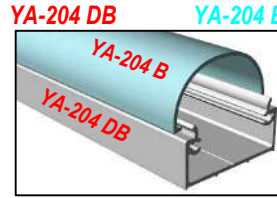

Mevcut 2 Difüzöre Uygun YENİ Alm.Prf. YA-204 DB İki ürüne özel, yeni alm.lazer kenar tapa çıkacaktır

YA-204 ALM. KASA VE AKSESUARLARI

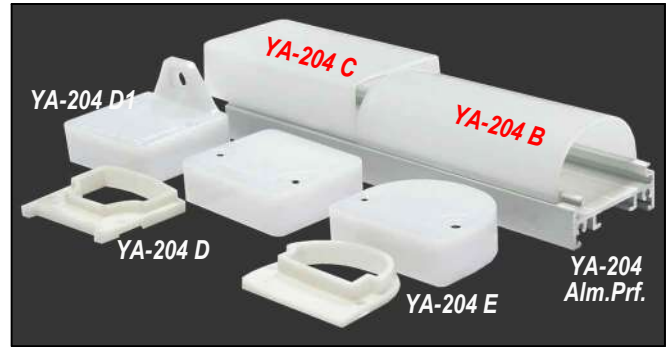

YA-204 E

Ken. Tapa-Conta



YA-204 D

Ken. Tapa-Conta



Beyaz PC.
IP 65 TAPA

YA-204 E 1

Kenar Tapa-Conta Polikarbon



YA-204 D 1

Kenar Tapa-Conta Polikarbon



Kulaklı
Beyaz PC.
IP 65 TAPA

IP 66 Uygun, İç-Dış Mekan Ürün

Gerektiğinde Sarkıt olarak da uygulanabilir
İki farklı P.C.Difüzör, dörd farklı IP 66 tapa seçenekleri
Tek-iki sıra led uygulanabilir

Yeni, YA-204 DB ve YA-204 DÇ kablo kanalı gibi de kullanıma uygundur.

YA-204 A DUVAR BĞLNT.

YA-204 B
YA-204 C

MONTAJ

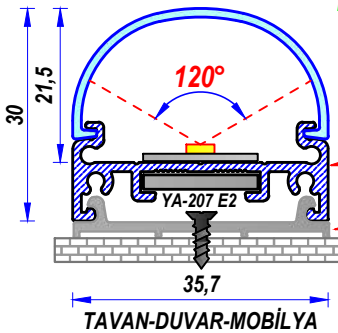

TAVAN-DUVAR-MOBİLYA

YA-204 DÇ DUVAR BĞLNT.

YA-204 C

MONTAJ

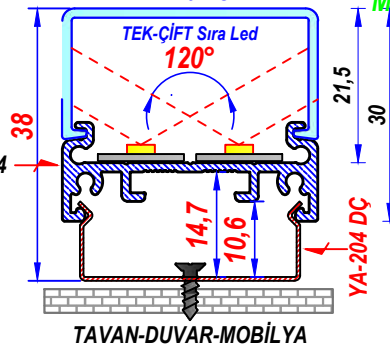

TAVAN-DUVAR-MOBİLYA

YA-204 DB ALM.DUV. BĞLNT.

TEK-ÇİFT Sıra Led

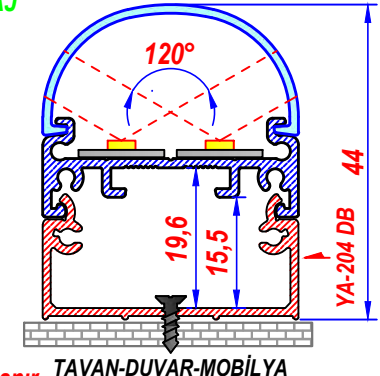

TAVAN-DUVAR-MOBİLYA

İstenilen ölçülerde kesim yapılır - İstenilen renge boyanır

All cutting dimensions and surface coatings can be done according to requirements

IP 66, İÇ-DİŞ MEKAN ÇİZGİSEL AYDINLATMA

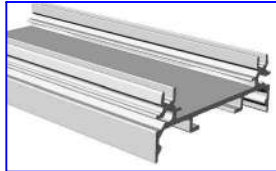
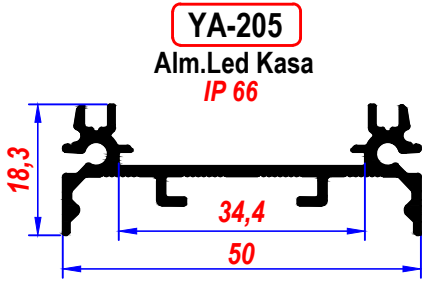

ALM.-PC.PRF. 610 cm

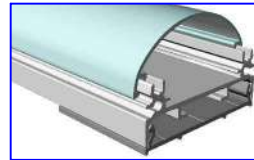

YA-205 YA-205 A

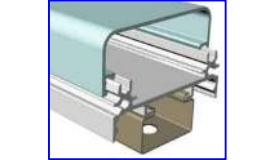

YA-205 YA-1203 D

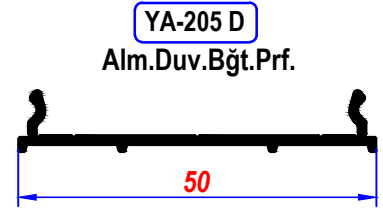

YA-254 C

Elastron fitil

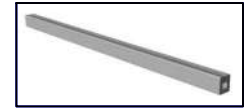

PC.Düfüzör Fitili

YA-205 C1

Ken.Tapa-Conta



A.Gri

PG 7 RAKOR a UYGUN DELİKLİ

YA-205 CK

Kulaklı Ken.Tapa-Conta

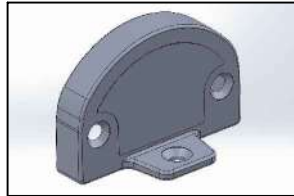

Plastik - A.Gri-KULAKLI

YA-205 U1

Ken.Tapa-Conta



A.Gri

PG 7 RAKOR a UYGUN DELİKLİ

YA-205 UK

Kulaklı Ken.Tapa-Conta



Plastik - A.Gri-KULAKLI

YA-201 D

Duvar Bağlt.Aprt.

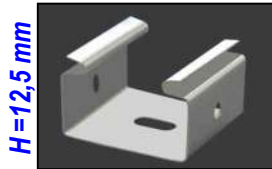

H=12,5 mm

PASLANMAZ KLİPS - ÇELİK

YA-1203 D

Duvar Bağlt. Aprt.



Alüminyum gövde de kullanılan, üç farklı duvar bağlantısı. YA-203 D, 8 mm lik TTR kabloya uygundur.

Benzerlerinden daha fazla fonksiyonel, İki farklı difüzör, üç duvar bağlantı aparatı, Dört farklı plastik kenar tapaları olan, PC cam fitili ile sızdırmazlık sağlayan, ekonomik ve dekoratif IP 66, ürün...

MONTAJ

ÜRÜNLER, İÇ-DİŞ MEKAN, LİNEER SARKIT OLARAK. YADA TAVANA DİREK MONTAJ EDİLEREK KULLANILIR

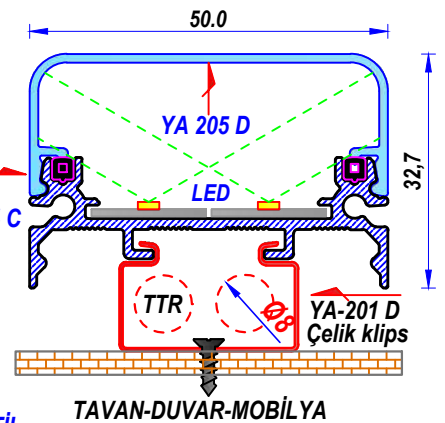
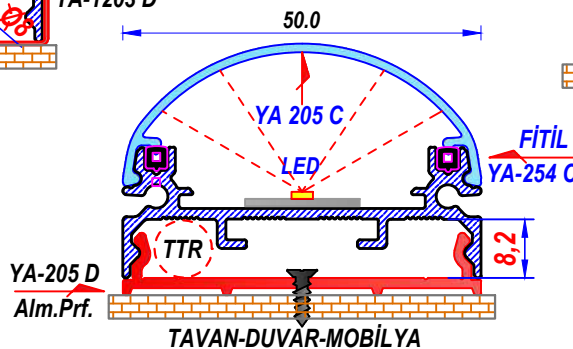
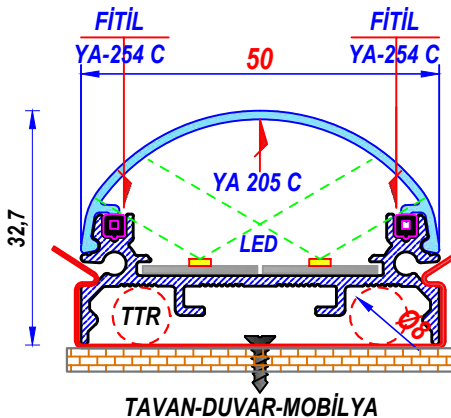

İstenilen ölçülerde kesim yapılır - İstenilen renge boyanır
All cutting dimensions and surface coatings can be done according to requirements

YA 204 A ALÜMİNYUM, LİNEER EKONOMİK UYGULAMA

YA-204 A

Alm. Duvar
Bağlantı Prf.



YA-204 A



ALM.PRF. 610 cm

YA-204 B

Oval P.C. Difüzör

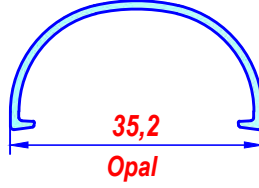

YA-204 B



PC. DİFÜZÖR 610 cm

YA-204 C

U P.C. Difüzör

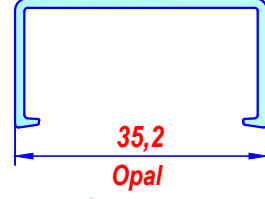

YA-204 C

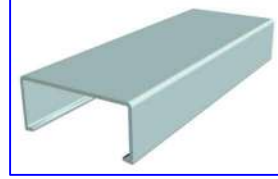

YA-204 A Alm. YA-204 B PC.

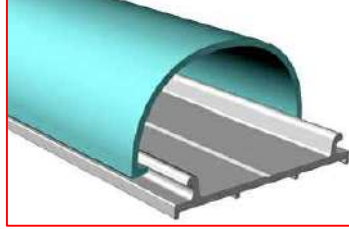

YA-204 A Alm. YA-204 C PC.

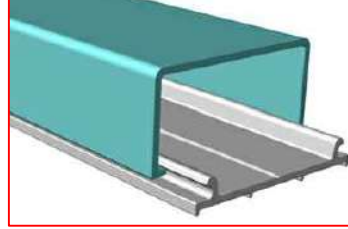

YA-204 A ALM. PROFİL VE AKSESUARLARI

YA-204 T

Pls.Kenar Tapa



Beyaz

YA-204 TK

Pls.Kenar Tapa



KULAKLI - RENK: Beyaz

YA-204 U

Pls.Kenar Tapa



Beyaz

YA-204 UK

Pls.Kenar Tapa



KULAKLI - RENK: Beyaz

KULAKLI KENAR TAPALAR KULLANILARAK, TAVAN VE DUVARA MONTAJ YAPILABİLİR

YA-204 A Alüminyum profille birlikte kullanılan,
4 farklı Yeni Plastik Kenar Tapa çeşitleri

TEK ve ÇİFT SIRA LEDE UYGUN
YA-204 B Difüzör

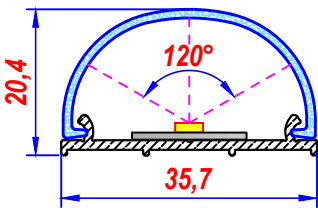

Üründe, YA-204 T ve YA-204 TK,
Kenar Tapalar Kullanılır

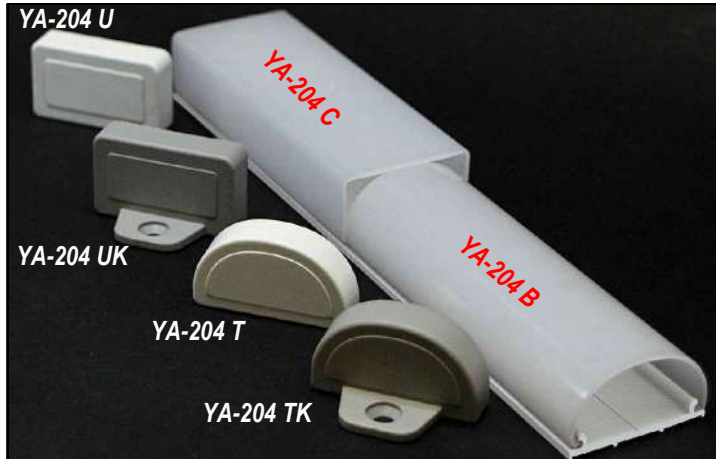

TEK ve ÇİFT SIRA LEDE UYGUN
YA-204 C Difüzör

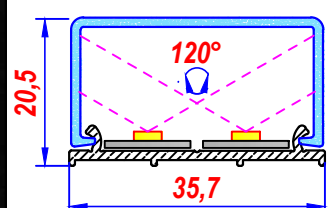

Üründe, YA-204 U ve YA-204 UK,
Kenar Tapalar Kullanılır

İstenilen ölçülerde kesim yapılır - İstenilen renge boyanır

All cutting dimensions and surface coatings can be done according to requirements

YÜKSEK TAVAN LED AYDINLATMA PROFİL VE AKSESUARLARI

YA-1201

Alm. Led Kasa
YÜKSEK TAVAN

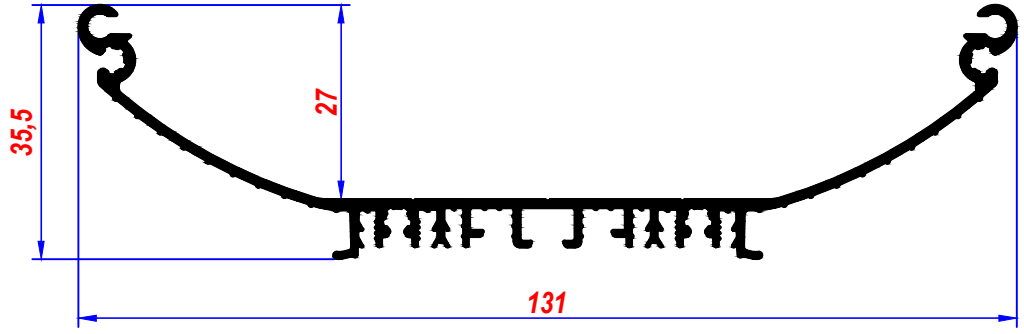

YA-1202

Alm. Driver-Kutu prf.

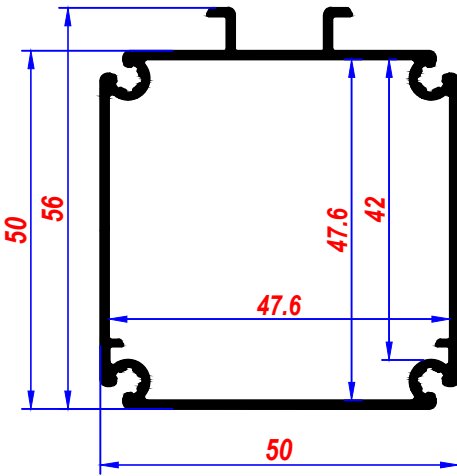

YA-1201 C

Akrilik Dİfüzör

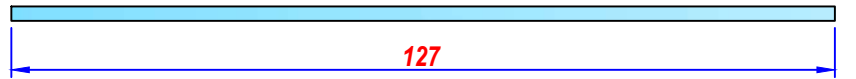

YA-1202 T

Metal Ken.Tp.+Conta

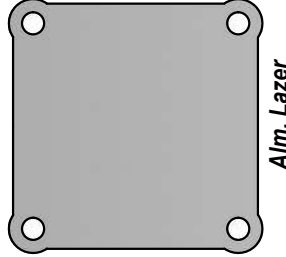

YA-1201 TL

Metal Ken. Tp.+Conta

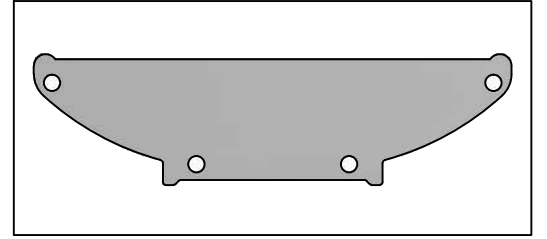

Pls.Tapa yakında çıkacak

YA-1201 ALM. LED KASA VE AKSESUARLARI

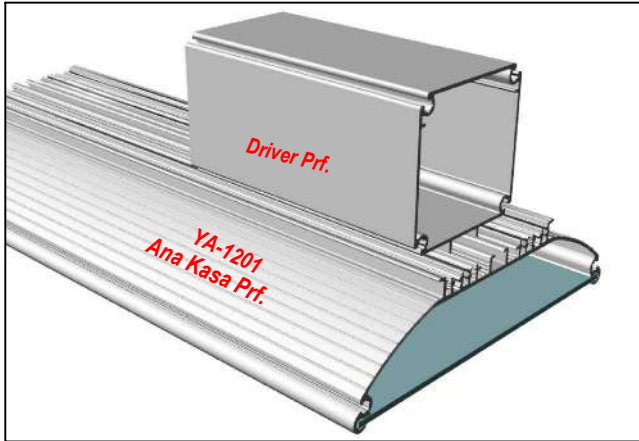

ALÜMİNYUM PROFİLLER 610 cm

YA-1201 LED KASA, Yüksek tavanlı endüstriyel mekanların aydınlatılması için, maksimum aydınlatma sağlar. Yüksek tasarruflu, dayanıklı, kaliteli, ekonomik ve modern bir seçenektir.

Sarkıt ve sıva üstü, montaj (Klips) seçenekleriyle, kurulum ve bakım işçiliği kolaydır.

IP 65 korumaya uygun, yeni Ekonomik ürün...

YA-1203 D

Duvar Bağlıt. Aprt.



KLİPS - ÇELİK

YA-207 D

Tavan Askı Aparatı-Tekli



PASLANMAZ-TEKLİ KROM

YÜKSEK TAVAN, DEPO-FABRİKA AYDINLATMA



İstenilen ölçülerde kesim yapılır - İstenilen renge boyanır

All cutting dimensions and surface coatings can be done according to requirements

YÜKSEK TAVAN IP 65 ALM. LED PROFİL VE AKSESUARLARI

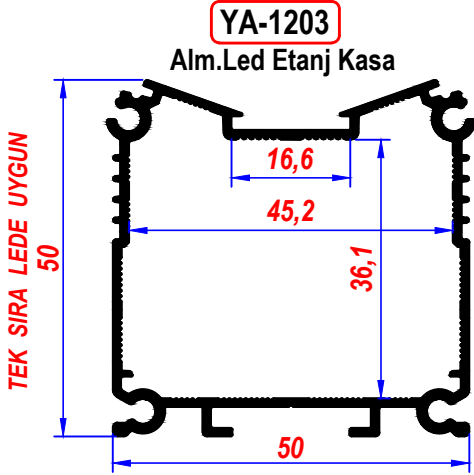

YA-1203 ALM. YA-1203 C PC.

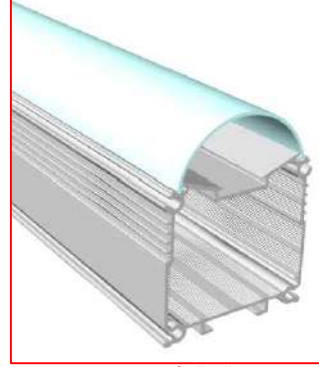

ALM. PRF. - PC. DİFÜZÖR 610 cm

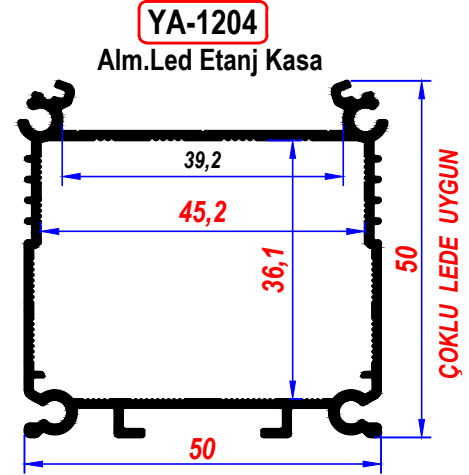

AKSESUARLAR, HER İKİ ÜRÜNE de UYGUNDUR

YA-1203 D

Duvar Bağlt. Aprt.



PASLANMAZ KLİPS - ÇELİK

YA-1203 C

PC Cam-Difüzör

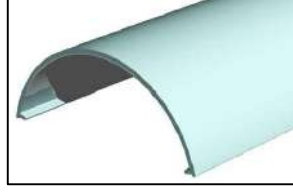

UZUNLUK 610 cm

YA-201 D

Duvar Bağlt. Aprt.



Paslanmaz Klips - H = 12,5mm
İçten Kavramalı, sağlam klips

YA-207 D

Tavan Askı Aparatı



Tekli-Krom - tel 1,5 mt
özel tel ölçüsü, sipariş edilir

Otopark - Yüksek tavan aydınlatma
Benzerlerinden, daha ekonomik ürün
IP 65 e Uygun, İç-Dış Mekan Ürün
Geniş driver alanı; 36,1 x 45,2 mm
(Acil aydınlatma kitine uygun)

Paslanmaz 2 farklı klipsle, kolay tavan
montajı

Sarkıt olarak kullanıma uygun aksesuarlar
Alt tırnağa, ayak seti (YA 253 serisi)
montaj edilerek, açılı kullanabilme imkanı

YA-1203 T

Pls.Ken.Tapa-Conta

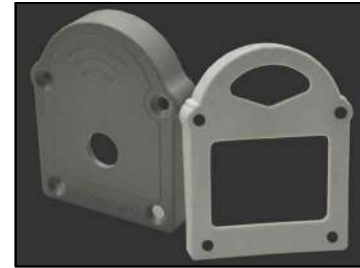

Faturalı Conta

MONTAJ

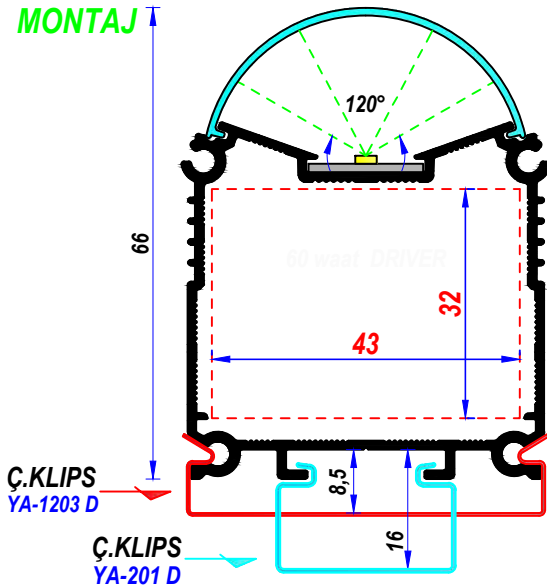

YA-1203 ALM.PRF. VE AKSESUARLARI

Alm.Prf.-PC Difüzör 610 cm



İstenilen ölçülerde kesim yapılır - İstenilen renge boyanır
All cutting dimensions and surface coatings can be done according to requirements

YENİ YA-1206 Y
Etanj prf.
Bombeli Difüzör

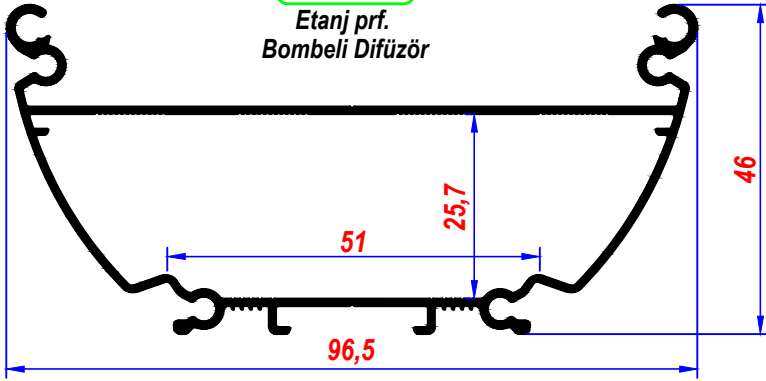

İSTENİLEN RENKDE ÜRETİLİR
İSTENİLEN ÖLÇÜLERDE KESİM YAPILIR

YA-1206 Y

YA-206 G

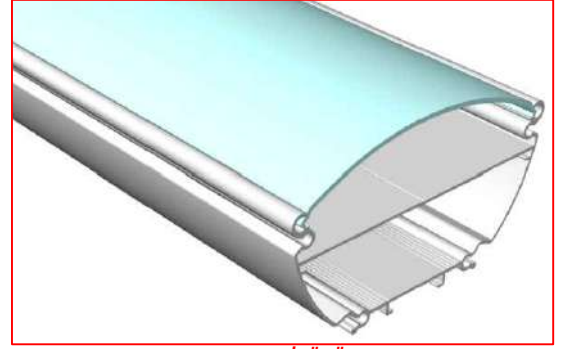

ALM. PRF. - PC. DİFÜZÖR 610 cm

YA-1206 T

Alm. Lazer Tapa

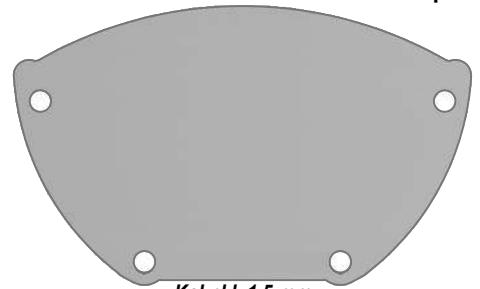

Kalınlık 1,5 mm

YA-206 G

P.C. Oval Difüzör
Opal - Çizgisiz

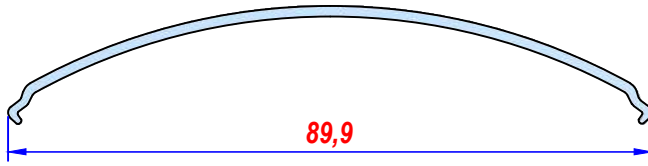

P.C. PRF. 305 cm

YENİ

YA-1206 C

P.C. Düz Difüzör

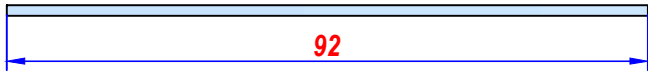

- * Paslanmaz klipsle, kolay tavan montajı,
- * Sarkıt olarak kullanıma uygun aksesuarlar,
- * İki farklı difüzörün, kullanılma imkanı,
- * Alt tırnağına ayak seti (YA 253 serisi) montaj edilerek, açılı kullanabilme imkanı.

YA-207 D

Tavan Askı Aparatı
Tekli-Krom



standart tel uzunluğu 1,5 mt

YA-1203 D

Duvar Bağlı. Aprt.



PASLANMAZ KLİPS - ÇELİK

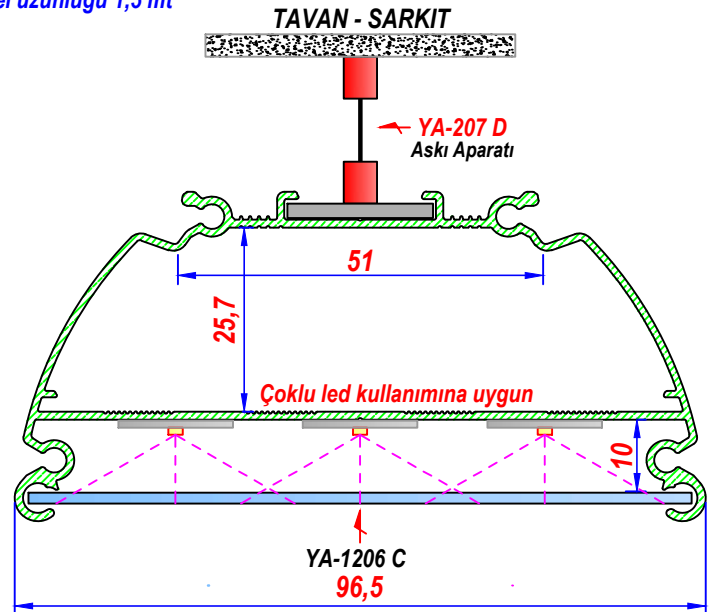
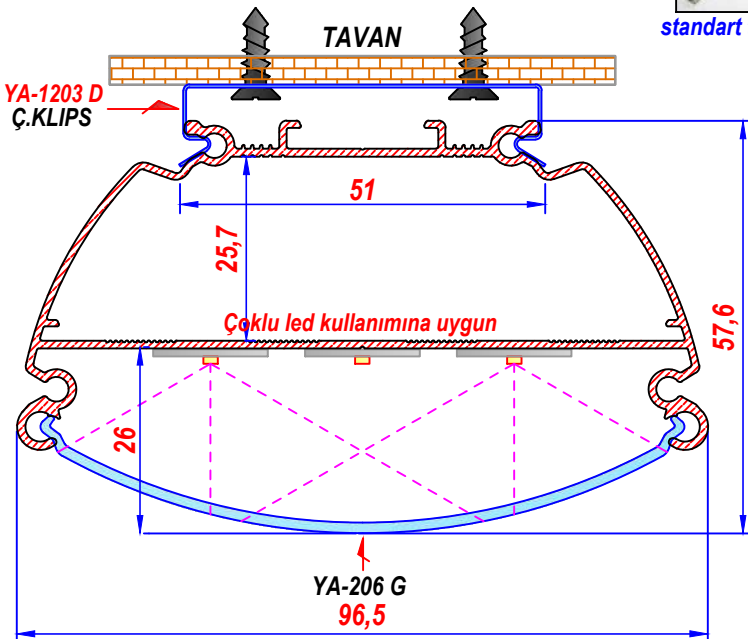

İstenilen ölçülerde kesim yapılır - İstenilen renge boyanır
All cutting dimensions and surface coatings can be done according to requirements

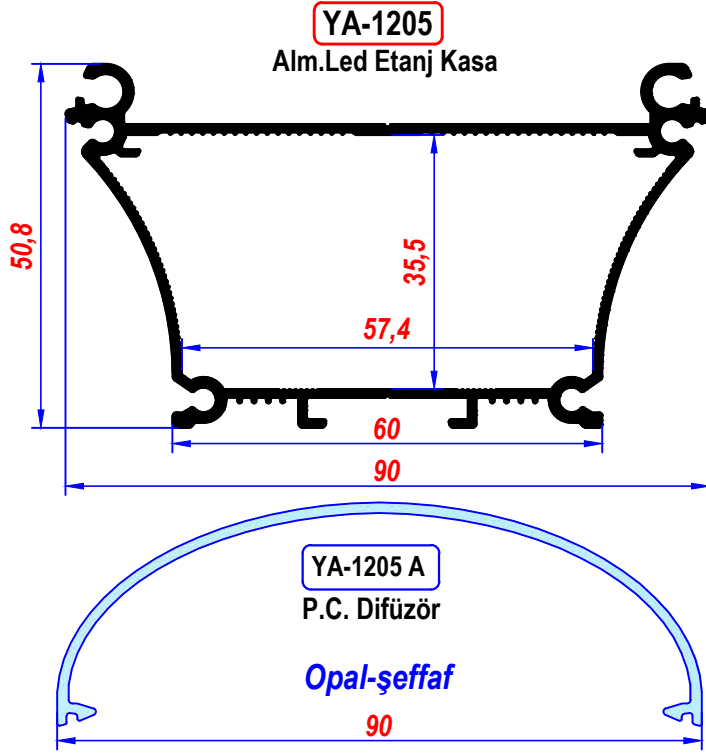

KLİPS - ÇELİK

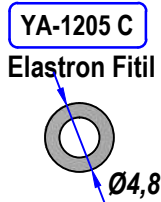

Ø4,8



özel tel ölçüsü sipariş edilebilir

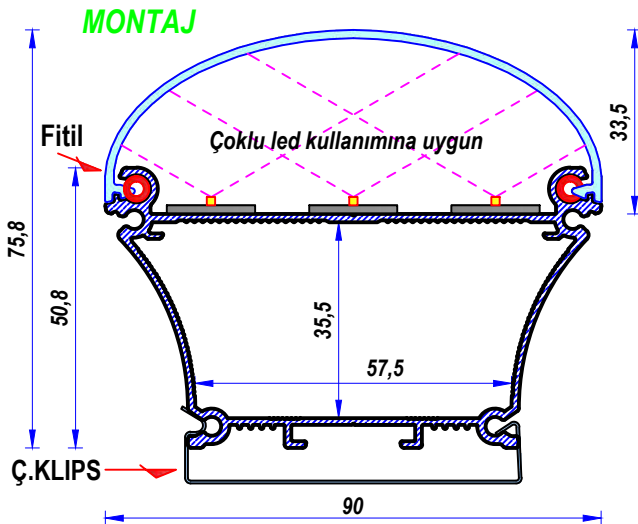

OTOPARK UYGULAMASI



- * IP 66 korumalı, fitilli etanj kasa
- * Geniş driver alanı; 35,5 x 57,4 mm (Acil aydınlatma kitine uygun)
- * Paslanmaz klipsle, kolay tavan montajı
- * PC.Dif. ile Alm. Prf. arasında, sızdırmaz fitili
- * Sarkıt olarak kullanıma uygun aksesuarlar
- * Alt tırnağına ayak seti (YA 253 serisi) montaj edilerek, açılı kullanabilme imkanı

YA-1205 B

Pls.Ken.Tapa-Conta

YA-1205 B1

Alm. Lazer Ken.Tapa

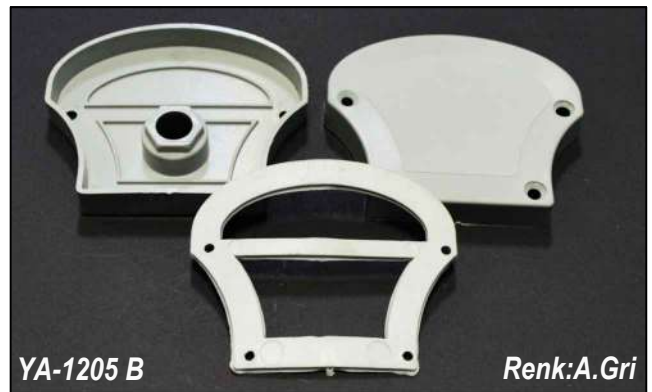

YA-1205 ALM.PRF. VE AKSESUARLARI



İstenilen ölçülerde kesim yapılır - İstenilen renge boyanır
All cutting dimensions and surface coatings can be done according to requirements

YA-208
Alu.Led
Etange Case

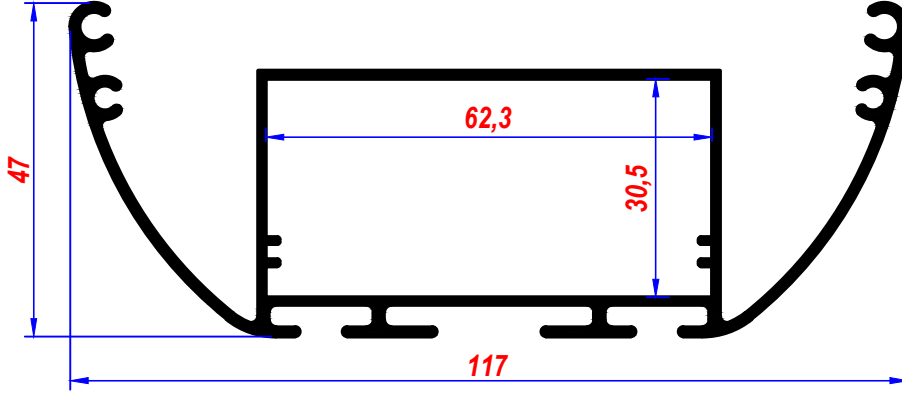

YA-208 A
PC. Diffuser
Opal - Transparent

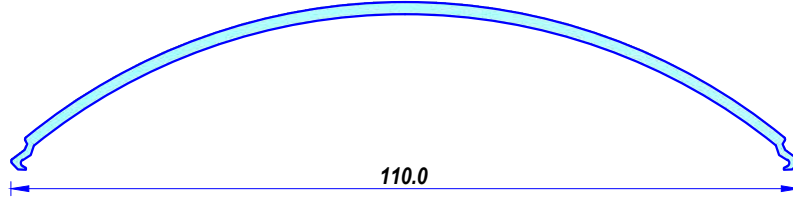

YA-208 B
Plastic End Cap
Black



YA-208 C
Alu. Laser End Cap
Light Gray



İÇ-DIŞ MEKAN, ETANJ AYDINLATMA ve AKVARYUM

YA-P01
Alu.Led Etange Case

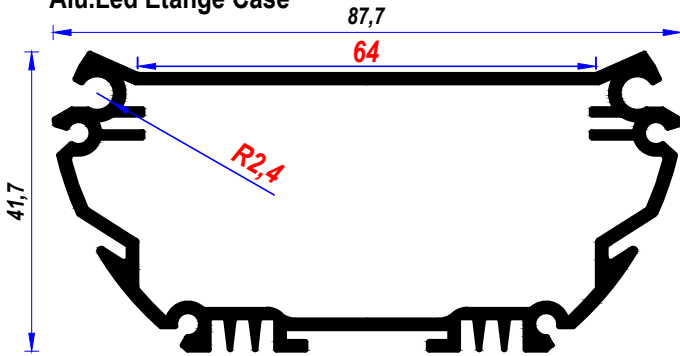

YA-P01 A
PC. Diffuser
Opal - Transparent

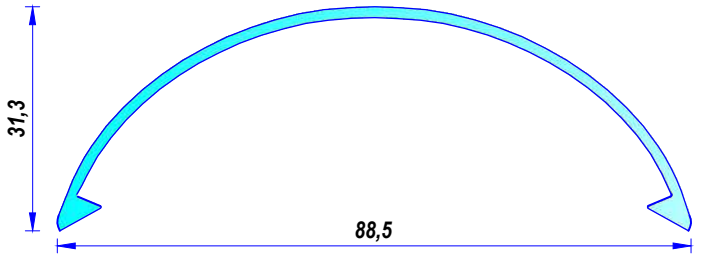

YA-P01 B
Alu. Laser End Cap
Light Gray

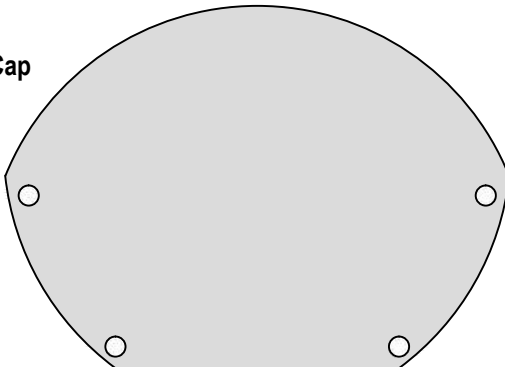

YA-1205 C
Elastron Wick

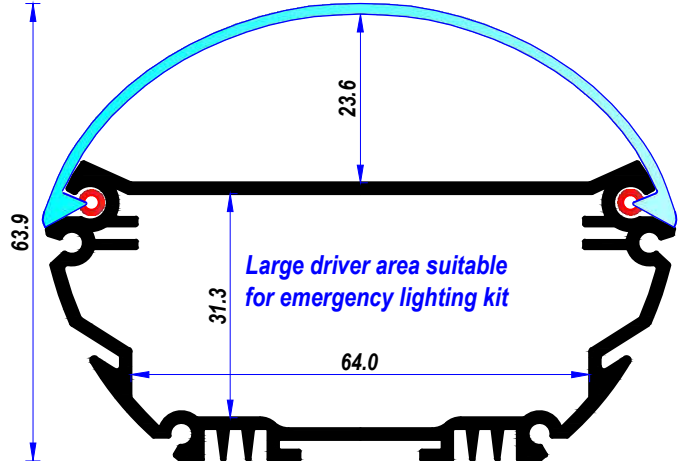
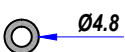

İstenilen ölçülerde kesim yapılır - İstenilen renge boyanır

YÜKSEK TAVAN IP 66 PC - COEX ETANJ KASALAR

EP-100

Plastik Led Etanj Kasa

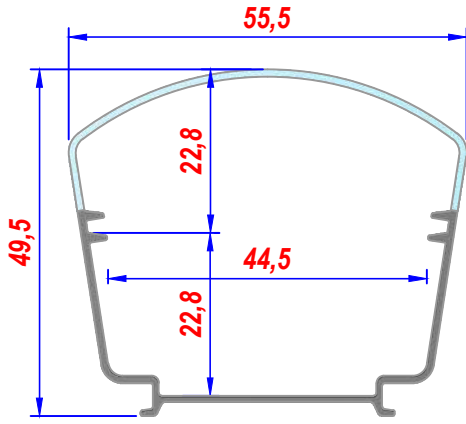

IP 66 KOEKS KÜÇÜK PC. KASA

EP-100 A

Alm.İç Sürgü Prf.



Alüminyum İç kızak-sürgü profili

P.C. ve ALM PRF. 305 cm
Otopark vb-Yüksek tavan aydınlatma
Paslanmaz klipsle, kolay tavan montajı
İç ve Dış mekânlarda kullanıma uygun
Benzerlerinden daha ekonomik ürün

EP-100 T

Pls.Kenar Tapa



VİDASIZ SIKI GEÇME

EP-100 D

Duvar Bağlt. Aprt.



PASLANMAZ KLİPS - ÇELİK

EP-101

Plastik Led Etanj Kasa

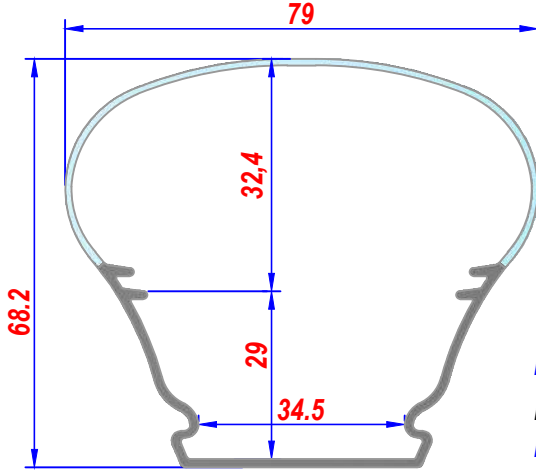

IP 66 KOEKS BÜYÜK PC. KASA

EP-101 A

Alm.İç Sürgü Prf.

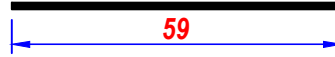

Alüminyum İç kızak-sürgü profili

Otopark vb-Yüksek tavan aydınlatma
Paslanmaz klipsle, kolay tavan montajı
İç ve Dış mekânlarda kullanıma uygun
Benzerlerinden daha ekonomik ürün

EP-101 T

Pls.Kenar Tapa



EP-101 D

Duvar Bağlt. Aprt.



PASLANMAZ KLİPS - ÇELİK

YENİ

EP-102

Plastik Led Etanj Kasa

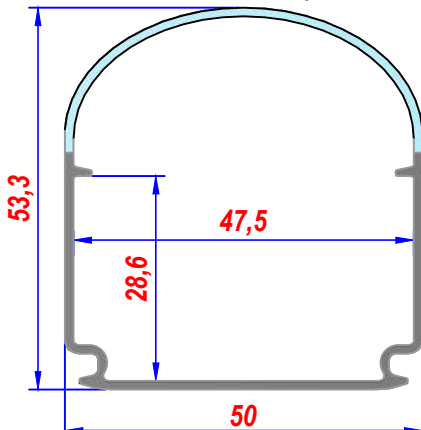

IP 66 KOEKS KÜÇÜK PC. KASA

EP-102 T

Pls.Kenar Tapa



EP-102 A

Alm.İç Sürgü Prf.

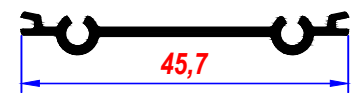

EP-102 D

Duvar Bağlt. Aprt.



PASLANMAZ KLİPS - ÇELİK

LİNEER İKİ YÖNLÜ LED KASASI

YA-215

Alm. Lineer Kasa
İki Nontadan Aydınlatma

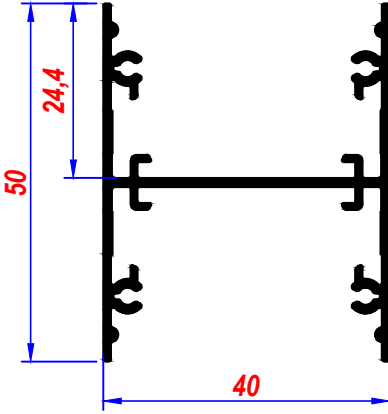

YA-213 D

Alm. Kapak Prf.

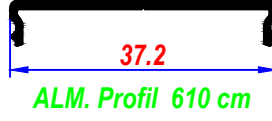

YA-1209 A

P.C. Difüzör



YA-215 LED U PROFİL

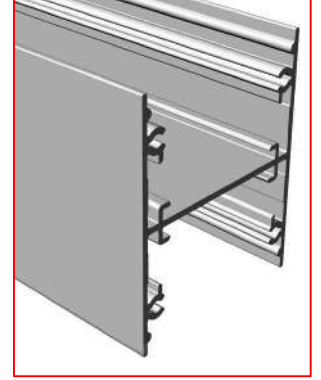

ALM. PRF. 610 cm

YA-215 T

Alm. L Ken.Tapa

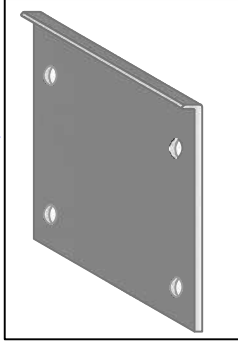

İstenilen renkte üretilir
Kalınlık 1,5 mm

Difüzör ile tapa arasında,
ışık sızdırmaz.

UYGULAMA ŞEKLİ;

İÇ MEKAN, ASKI APARATLARI İLE SARKIT,
TAVAN-DUVARA VİDA İLE SABİTLEYEREK

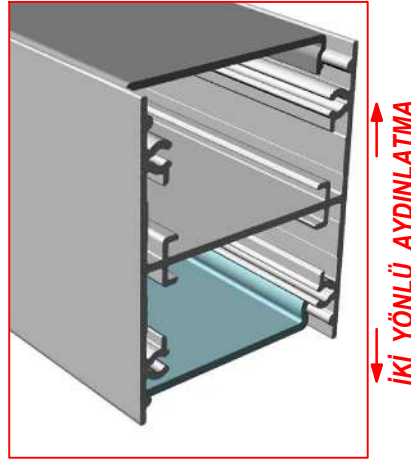

İKİ YÖNLÜ AYDINLATMA

DİKEY METAL İÇ KÖŞE APARATI



GENİŞLİK 12 mm

- YA-218 K1 30° Metal Köşe
- YA-218 K2 45° Metal Köşe
- YA-218 K3 60° Metal Köşe
- YA-218 K4 90° Metal Köşe
- YA-218 K5 120° Metal Köşe
- YA-218 K6 135° Metal Köşe
- YA-218 K7 150° Metal Köşe

UYGULAMA 3

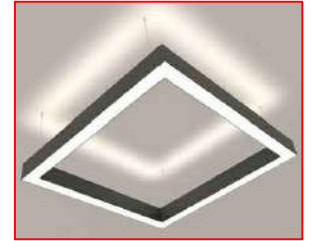

UYGULAMA 3

PC. Difüzör

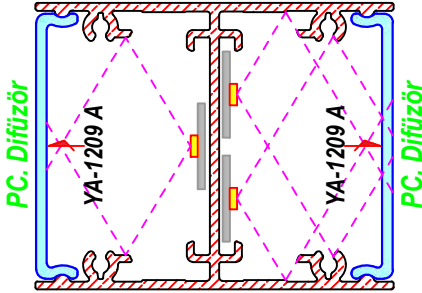

UYGULAMA 1 TAVAN MONTAJ

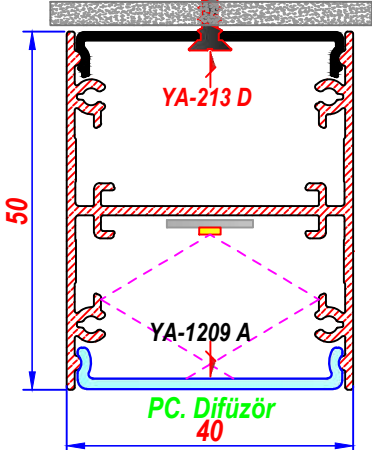

PC.DİFÜZÖR - ALM. PRF.ler 610 cm

TAVAN - SARKIT

YA-207 D Askı Aparatı UYGULAMA 2

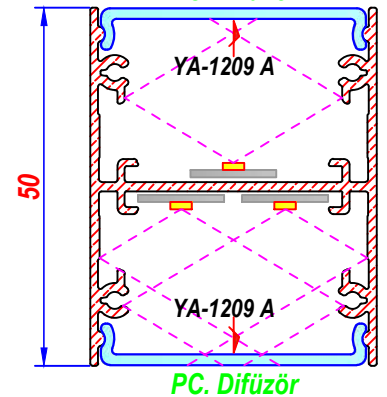
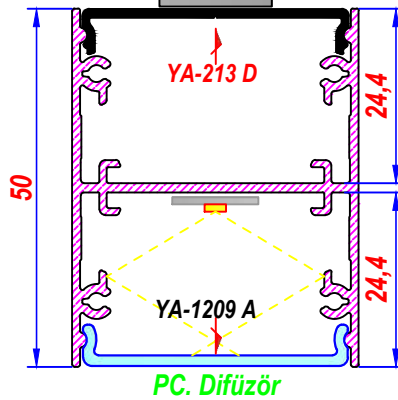

İstenilen ölçülerde kesim yapılır - İstenilen renge boyanır

All cutting dimensions and surface coatings can be done according to requirements

EKONOMİK SLİM LİNEER KASA

YENİ

YA-217

Alm. Lineer Kasa
İnce - Slim

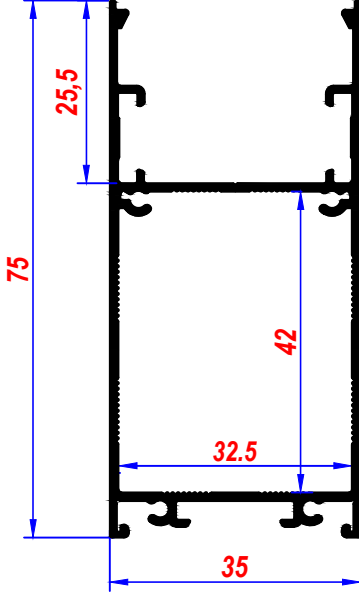

YA-G 35 C

PC.Cam-Difüzör

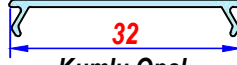

Kumlu Opal
PC. Difüzör 610 cm

YA-217 T

Alm. L Ken.Tapa



İstenilen renkte üretilir
Kalınlık 1,5 mm

Difüzör ile tapa arasında,
ışık sızdırmaz.

Lineer ürünlerde, Yeni L TAPA

YA-217 ALM. PRF.

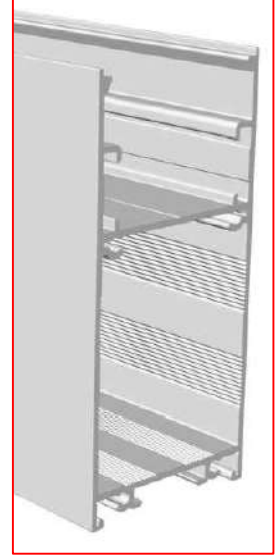

ALM. - PC. PRF. 610 cm

YA-204 A

Alm. Tavan
Bağlantı Prf.

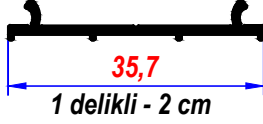

1 delikli - 2 cm

YA-207 D

Tavan Askı Aparatı



standart tel 1,5 mt

Tekli Krom

YA-207 E1

Yatay 90° Metal Köşe



Gen.16,3 mm

Kalınlık 2,5 mm

YA-207 E3

Metal Düz Gönye



Gen.16,3 mm

Uz.110 mm
Kalınlık 2,5 mm

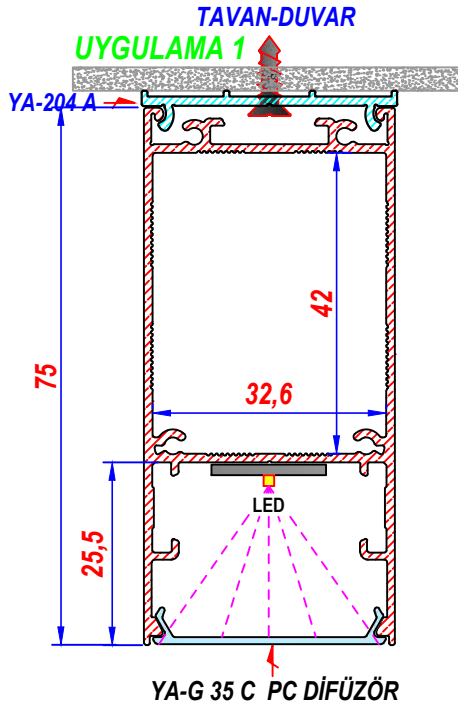

YA-G 35 C PC DİFÜZÖR

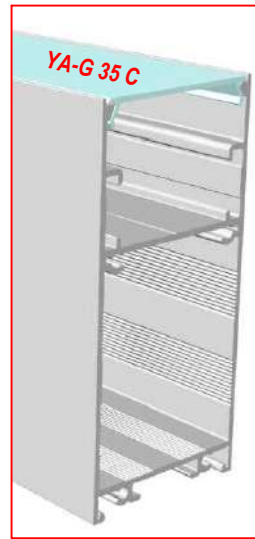

ALM. - PC. PRF. 610 cm

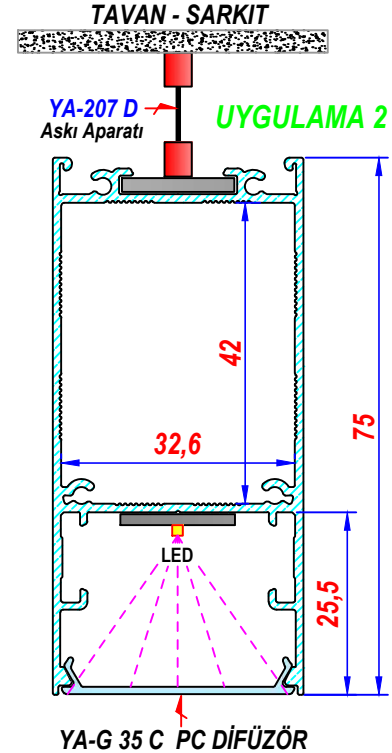

YA-G 35 C PC DİFÜZÖR

İstenilen ölçülerde kesim yapılır - İstenilen renge boyanır
All cutting dimensions and surface coatings can be done according to requirements

EKONOMİK LİNEER KASA

YENİ

YA-219

Alm. Lineer Kasa
Ekonmik Model

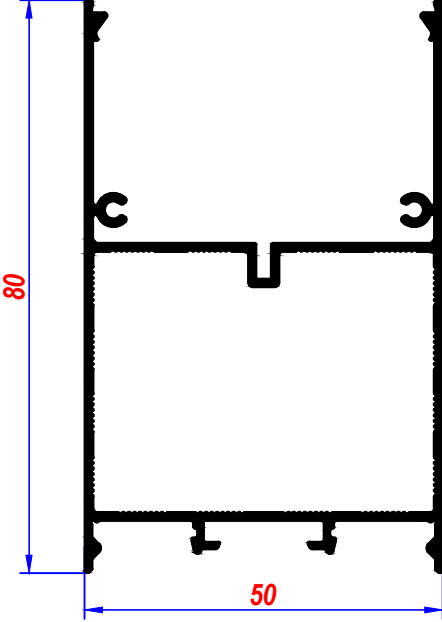

UYGULAMA ŞEKLİ;

İÇ MEKAN, ASKI APARATLARI İLE SARKIT,
TAVAN-DUVARA VİDA İLE SABİTLEYEREK

TAVAN SARKIT UYGULAMASI



YA-219 T

Alm. L Ken.Tapa

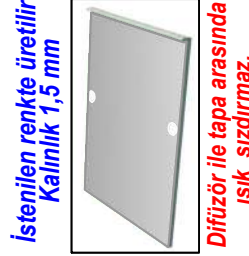

İstenilen renkte üretilir
Kalınlık 1,5 mm

Difüzör ile tapa arasında
ışık sızdırmaz.

Lineer ürünlerde, Yeni L TAPA

YA-G 50 A

PC.Cam-Difüzör



47

Kumlu Opal

PC.Cam-Difüzör, üstten tatlı sıkı,
takılıp çıkartılabilir

YA-205 D

Alm. Prf. (Duvar Montaj)

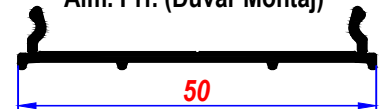

50

Ürün, 5 cm kısa parçalar halinde
bağlantı klipsi gibi de kullanılır

YA-207 D

Tavan Askı Aparatı



Tekli KROM

özel tel ölçüsü sipariş edilebilir-Standart tel: 1,5 mt

YA-207 D1

Tavan Askı Aparatı



İkili KROM

YA-207 E1

Yatay 90° Metal Köşe



Gen.16,3 mm

Kalınlık 2,5 mm

YA-207 E3

Metal Düz Gönye



Gen.16,3 mm

Uz.110 mm
Kalınlık 2,5 mm

YA-205 D Kullanılmadan, tavan veya
duvara, direkt YA-219 vidalayarak, uygulanır.

İsteğe göre, YA-205 D Tavana vidayla sabitlenir,
daha sonra ana kasaya, sıkı geçme takılır.

UYGULAMA 1 TAVAN MONTAJ

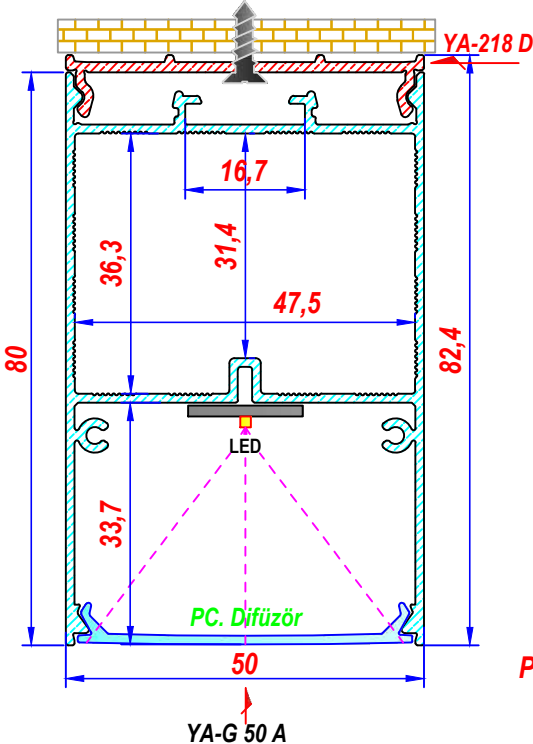

MONTAJ

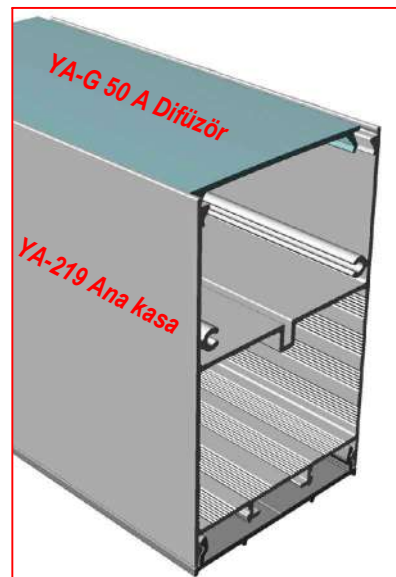

PC.DİFÜZÖR - ALM. PRF.ler 610 cm

UYGULAMA 2 TAVAN SARKIT

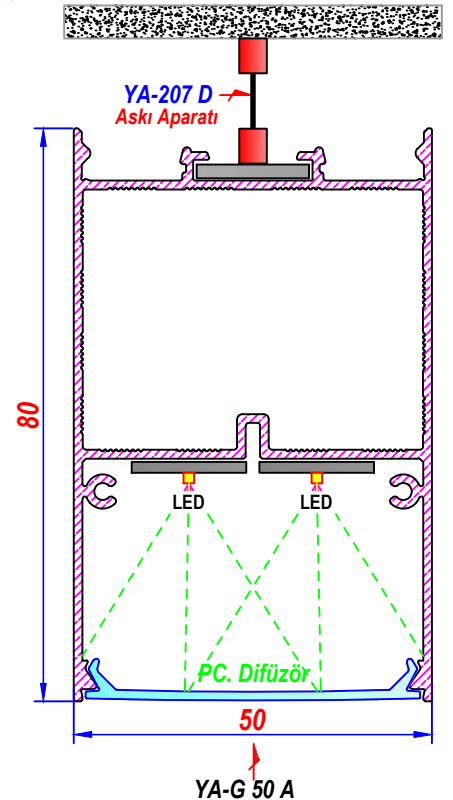

İstenilen ölçülerde kesim yapılır - İstenilen renge boyanır

All cutting dimensions and surface coatings can be done according to requirements

YA-221

Alm. Linear Kasa
Ekenomik Model

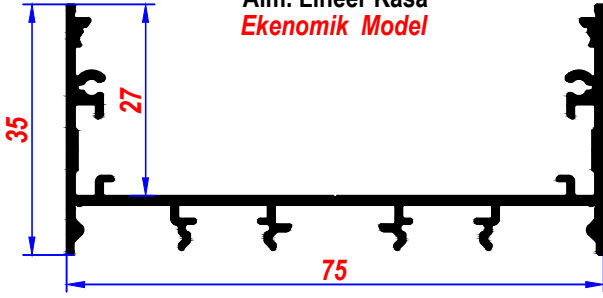

HARİCİ DRIVER İİ, SLİM LINEER ÜRÜN

TAVAN-DUVARA VİDA İLE SABİTLEYEREK

UYGULAMA 1

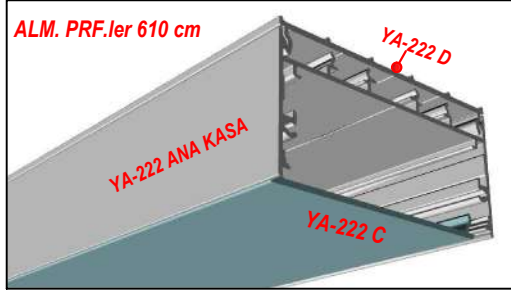

Tavan Montaj. Tek yönlü, aşağı aydınlatma

YA-221 T

Alm. L Ken. Tapa

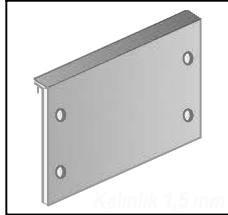

DİFÜZÖR ile tapa arasında,
ışık sızdırmaz.

YA-019 C

PC. Cam-Difüzör

11,4

Opal, Şeffaf-ÇİZGİLİ

FÜME PC. çok yakında
610 cm

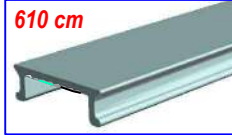

YA-207 D

Tavan Askı Aparatı



Teke KROM özel tel ölçüsü sipariş edilebilir-Standart tel: 1,5 mt

YA-207 D1

Tavan Askı Aparatı



İkili KROM

UYGULAMA 1

TAVAN-DUVAR MONTAJ

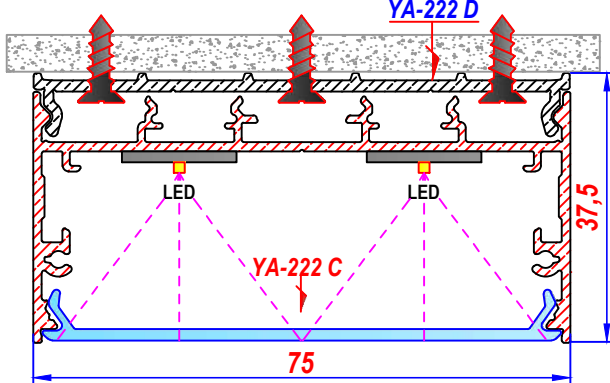

İstenilen ölçülerde kesim yapılır - İstenilen renge boyanır

All cutting dimensions and surface coatings can be done according to requirements

YA-222 C

PC. Cam-Difüzör

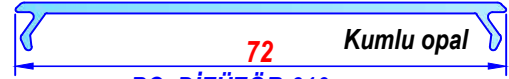

PC. DİFÜZÖR 610 cm

PC. Cam-Difüzörler, üstten tatlı sıkı,
takılıp çıkartılabilir

YA-222 D

Alm. Prf. (Duvar Montaj)

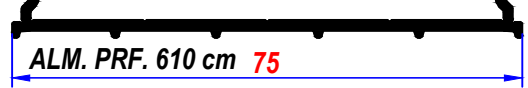

İÇ MEKAN, ASKI APARATLARI İLE SARKIT,

UYGULAMA 2

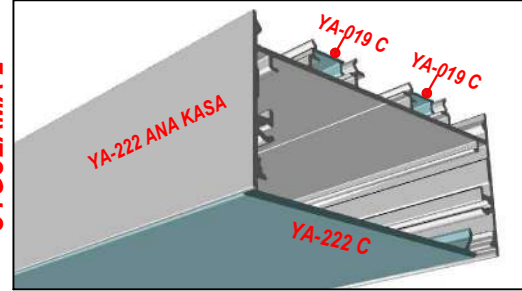

İKİ YÖNLÜ AYDINLATMA

Sarkıt uygulama. Yukarı ve aşağı aydınlatma

DİKEY METAL
İÇ KÖŞE APARATLARI



GENİŞLİK 12 mm

- | | |
|-----------|-----------------|
| YA-218 K1 | 30° Metal Köşe |
| YA-218 K2 | 45° Metal Köşe |
| YA-218 K3 | 60° Metal Köşe |
| YA-218 K4 | 90° Metal Köşe |
| YA-218 K5 | 120° Metal Köşe |
| YA-218 K6 | 135° Metal Köşe |
| YA-218 K7 | 150° Metal Köşe |

UYGULAMA ŞEKLİ

İç mekan, askı aparatları ile sarkıt,
Tavan ve duvara direkt vida ile sabitleyerek.
İsteğe göre YA-222 D, Tavana vidayla sabitlenir,
daha sonra ana kasaya, sıkı geçme takılır.

UYGULAMA 2 TAVAN SARKIT

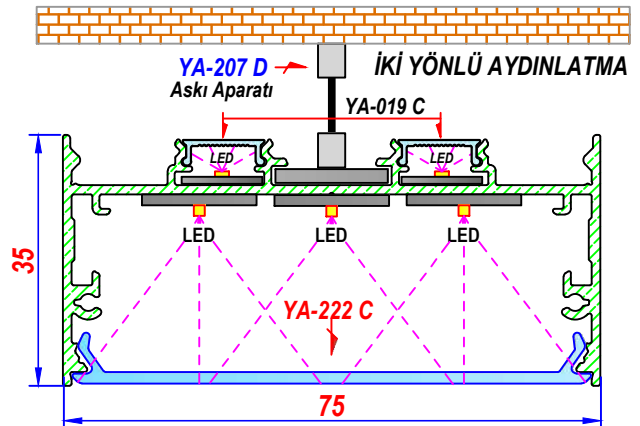

YA-226

Alm. Lineer Kasa
Ekenomik ÜRÜN

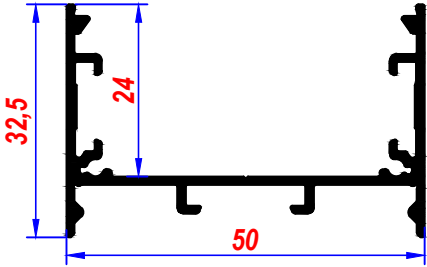

YA-226 Alm.Prf. YA-G 50 A PC.Prf.

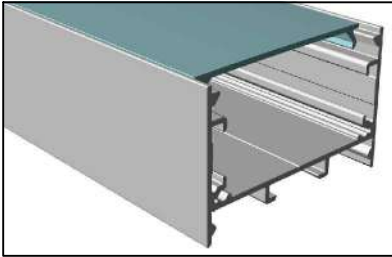

ALM. PRF.- PC. PRF. 610 cm

YA-226 T

Alm. L Ken.Tapa

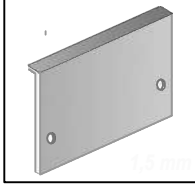

UYGULAMA 1 TAVAN MONTAJ

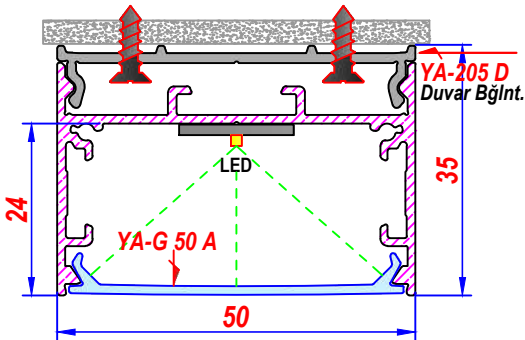

UYGULAMA 2 TAVAN SARKIT

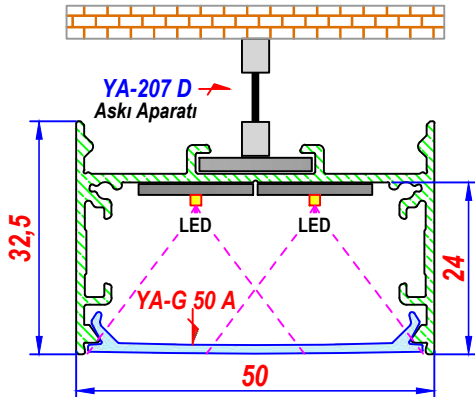

YA-G 50 A

PC.Cam-Difüzör

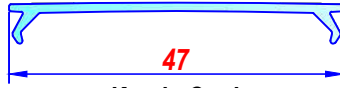

PC.Cam-Difüzör, üstten tatlı sıkı,
takılıp çıkartılabilir

YA-205 D

Alm. Prf. (Duvar Montaj)

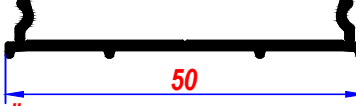

Ürün, 5 cm kısa parçalar halinde,
her iki kasaya da, tavan bağlantı
klipsi gibi kullanılır

YA-207 D

Tavan Askı Aparatı



Tekli KROM

YA-207 D1

Tavan Askı Aparatı



İkili KROM

YA-207 E1

Yatay 90° Metal Köşe



YA-207 E3

Metal Düz Gönye



DİKEY METAL
İÇ KÖŞE APARATLARI



- YA-218 K1 30° Metal Köşe
- YA-218 K2 45° Metal Köşe
- YA-218 K3 60° Metal Köşe
- YA-218 K4 90° Metal Köşe
- YA-218 K5 120° Metal Köşe
- YA-218 K6 135° Metal Köşe

YENİ YA-229

Alm. Lineer Kasa
Lense Uygun ÜRÜN
Düz Difüzöre uygun

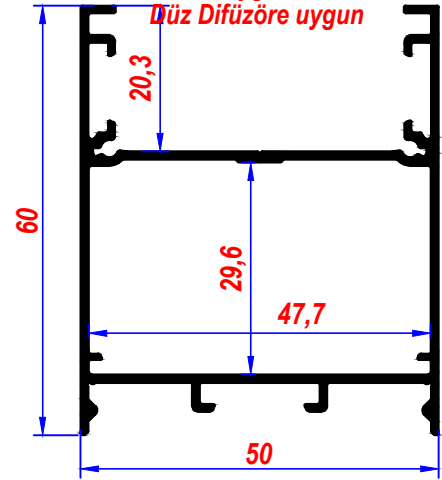

YA-229 C



1,5 mm PC.Difüzör
2,5 mm Pirizmatik Difüzör

ALM.KASA- REFLEKTÖR - LENS



YA-229 Alm.
YA-229 RF
YA-229 LS

SARKIT & TAVANA YA-205 D ile MONTAJ

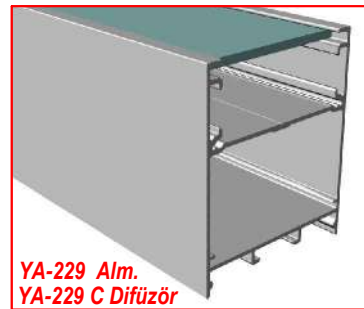

YA-229 Alm.
YA-229 C Difüzör

ALM.KASA- DÜZ DİFÜZÖR

YA-229 RF

Pls.Reflektör

YA-229 LS

Lens-Mercek

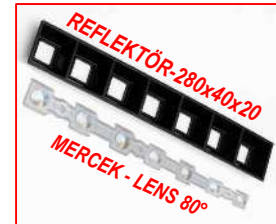

YA-229 T

Alm. L Ken.Tapa

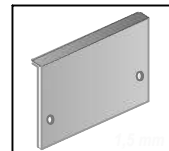

YENİ, EKONOMİK KÜÇÜK LİNEER PROFİLLER

YENİ

YA-214

Alm. Lineer Kasa

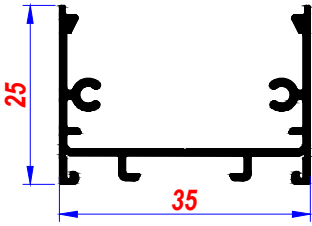

Ekonomik-Lineer Profil

YA-G 35 C

PC.Cam-Difüzör

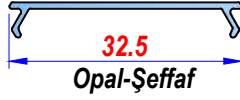

Sürülebilir Difüzörlü

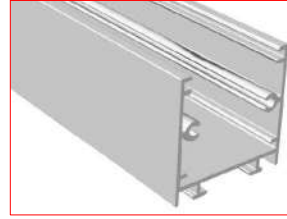

YA-213 ALM. PRF. 610 cm
İSTENİLEN RENGE BOYANIR

YENİ

YA-228

Alm. Lineer Kasa

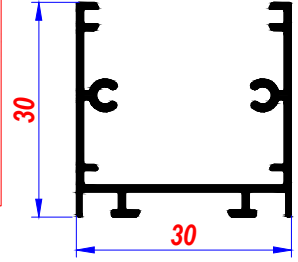

YA-228 ALM.

YA-228 C PC.

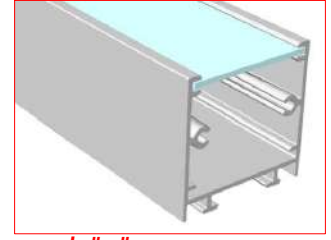

PC.DİFÜZÖR-ALM.PRF. 610 cm

YA-214

YA-G 35 C

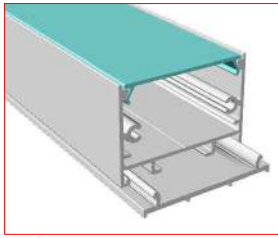

PC.DİFÜZÖR-ALM.PRF. 610 cm

YA-204 A

Alm. Duvar
Bağlantı Prf.

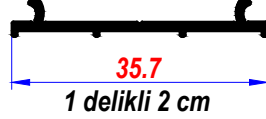

YA-228 C

PC.Cam-Difüzör



YA-214 L ve YA-228 L Alm.Ken.Tapalar,
yeni üründür. Difüzör ile tapa arasında,
ışık sızdırmaz. Düz tapaya göre, daha
dekoratif olup, istenilen renge boyanabilir

YENİ

YA-228 L

Alm. L Ken.Tapa

İstenilen renkte üretilir

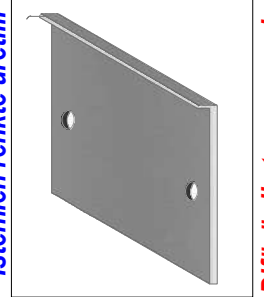

Difüzör ile tapa arasında,
ışık sızdırmaz.

Lineer ürünlerde, Yeni L TAPA

YENİ

YA-214 L

Alm. L Ken.Tapa

İstenilen renkte üretilir

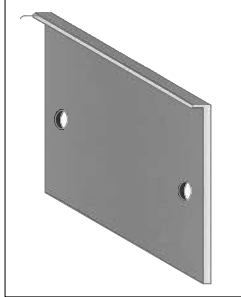

Difüzör ile tapa arasında,
ışık sızdırmaz.

Lineer ürünlerde, Yeni L TAPA

YA-207 D

Tavan Askı Aparatı



YA-207 D1

Tavan Askı Aparatı



YA-207 E1

Yatay 90° Metal Köşe



Gen.16,3 mm

YA-207 E3

YATAY

Düz Gönye

YA-207 E4

Artı Gönye

YA-207 E5

120° Gönye

YA-207 E6

135° Gönye

YA-207 E7

150° Gönye

UYGULAMA ŞEKLİ;

İÇ MEKAN, ASKI APARATLARI İLE SARKIT,
TAVAN a YA-204 A APARATI KULLANARAK

UYGULAMALAR

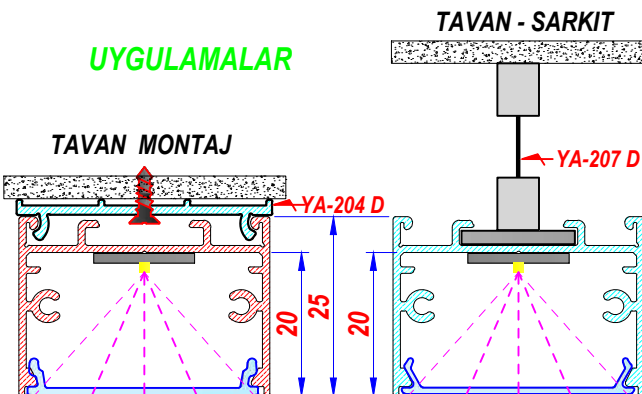

UYGULAMA ŞEKLİ

İç mekan askı aparatları ile sarkıt,
Tavan veya duvara vidayla sabitleyerek

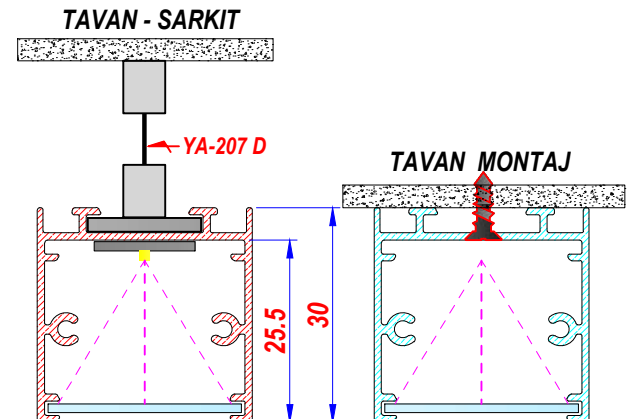

İstenilen ölçülerde kesim yapılır - İstenilen renge boyanır

All cutting dimensions and surface coatings can be done according to requirements

YENİ

YA-213

Alm. Lineer Kasa

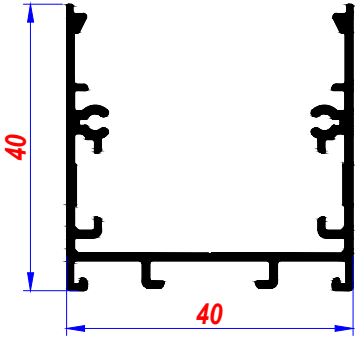

TAVAN MONTAJI KOLAY ÜRÜN
İki farklı PC. Difüzör Seçeneği

YA-213 A

Alm. Prf. (Duvar Montaj)

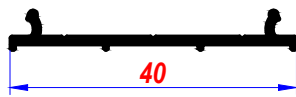

Kolay uygulanabilir, tavan montaj aparatı

Ürün 3 cm lik parçalar halinde kullanılabilir

YA-213 ALM. YA-213 C PC.

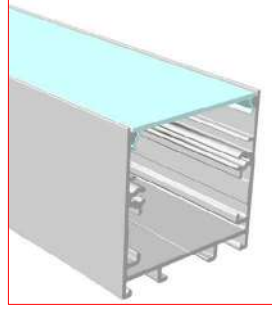

PC.DİFÜZÖR-ALM.PRF. 610 cm

YA-213 ALM. YA-213 U PC.

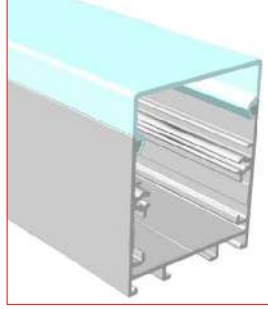

YENİ

YA-213 C

P.C. Difüzör



P.C. DİFÜZÖRLER 610 cm

YENİ **YA-213 U**

P.C. U Difüzör

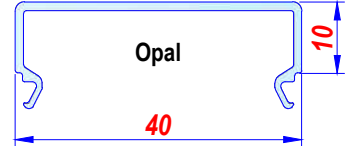

YA-213 L

Alm. L Ken.Tapa

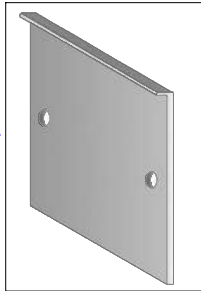

Düz difüzöre uygun

YA-213 L 1

Alm. L Ken.Tapa

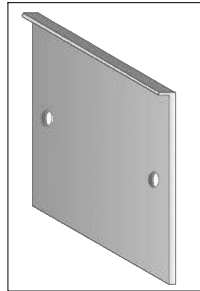

U Difüzöre uygun

YA-1209 C

Alm. Kızak Prf.



YA-207 D

Tavan Askı Aparatı



Tekli-Krom

YA-207 D1

Tavan Askı Aparatı



İkili-Krom

YA-207 E1

Yatay 90° Metal Köşe



Kalınlık 2,5 mm



Her iki camla birlikte tavan sarkıt olarak kullanılabilir
İsteğe göre; YA-213 A, Tavan veya duvara vidayla sabitlenir
Daha sonra ana kasa (YA-213 e), sıkı geçme takılır
İSTENİLEN ÖLÇÜ ve ŞEKİLLERDE ÇERÇEVE YAPILIR

MONTAJ VE UYGULAMA ŞEKİLLERİ

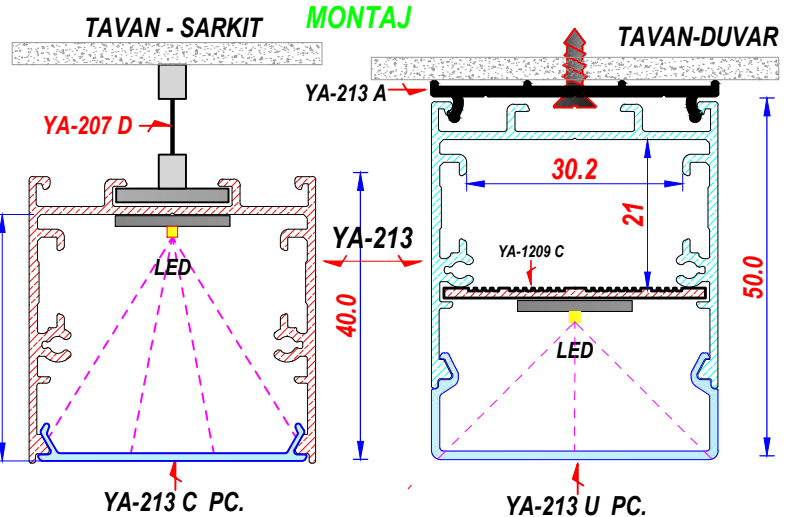

DİKEY METAL İÇ KÖŞE APARATLARI



Genişlik:12 mm

YA-218 K1 30° Metal Köşe

YA-218 K2 45° Metal Köşe

YA-218 K3 60° Metal Köşe

YA-218 K4 90° Metal Köşe

YA-218 K5 120° Metal Köşe

YA-218 K6 135° Metal Köşe

YA-218 K7 150° Metal Köşe

YATAY İÇ KÖŞE (16 mm) APARATLARI da MEVCUT

YA-213 YA-213 A YA-213 C

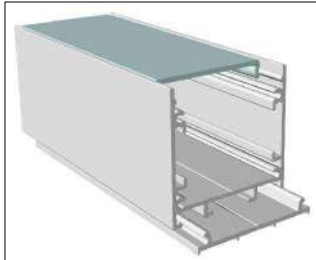

PC.DİFÜZÖR-ALM.PRF. 610 cm

İSTENİLEN ÖLÇÜLERDE ÇERÇEVE YAPILIR

45° AÇI İLE KESİLİP, KARE-DİKDÖRTGEN GİBİ

DEKORATİF ŞEKİLLERDE ÇERÇEVE ÜRETİLEBİLİR

İstenilen ölçülerde kesim yapılır - İstenilen renge boyanır

All cutting dimensions and surface coatings can be done according to requirements

YENİ
YA-1209

Alm. Lineer Kasa

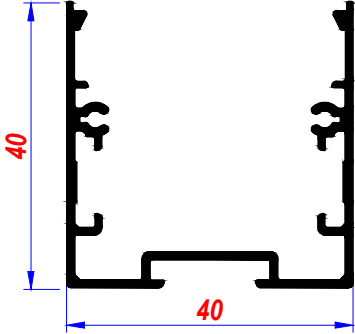

İSTENİLEN RENKDE ÜRETİLİR
İki farklı PC. Difüzör Seçeneği

YA-1209 ALM. YA-213 C PC.

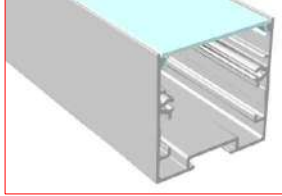

PC.DİFÜZÖR-ALM.PR.F. 610 cm

YA-1209 ALM. YA-213 U PC.

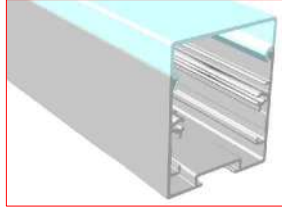

YENİ

YA-213 C

P.C. Difüzör

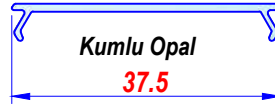

P.C. DİFÜZÖRLER 610 cm

YENİ **YA-213 U**
P.C. U Difüzör

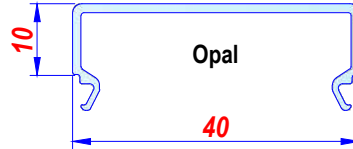

YA-1209 C
Alm. Kızak Prf.



YA-1209 ALM. PR.F. 610 cm

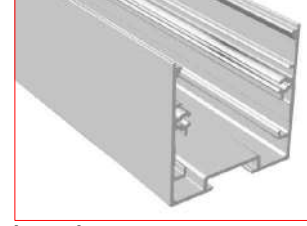

İSTENİLEN RENGE BOYANIR

YA-1209 L

Alm. L Ken.Tapa

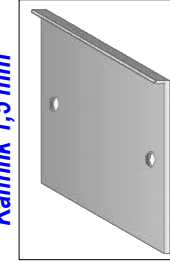

Kalınlık 1,5 mm

YA-1209 L1

Alm. L Ken.Tapa

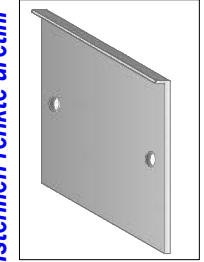

Kalınlık 1,5 mm

Düz difüzöre uygun

U Difüzöre uygun

TAVAN - SARKIT

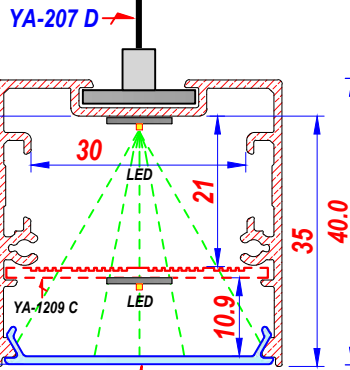

YA-213 C PC.

UYGULAMA ŞEKİLLERİ

TAVAN-DUVAR

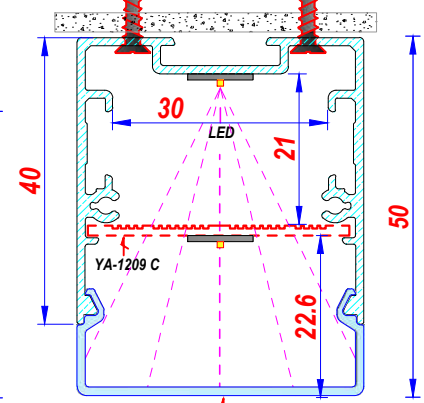

YA-213 U PC.

YA-207 E1

Yatay 90° Metal Köşe



Gen.16,3 mm

YA-207 E3 **YATAY**
Düz Gönye

YA-207 E4 **Artı Gönye**

YA-207 E5 **120° Gönye**

YA-207 E6 **135° Gönye**

YA-207 E7 **150° Gönye**

DIKEY METAL İÇ KÖŞE APARATLARI



GENİŞLİK 12 mm

YA-218 K1 30° Metal Köşe

YA-218 K2 45° Metal Köşe

YA-218 K3 60° Metal Köşe

YA-218 K4 90° Metal Köşe

YA-218 K5 120° Metal Köşe

YA-218 K6 135° Metal Köşe

YA-218 K7 150° Metal Köşe

YATAY İÇ KÖŞE (16 mm)
APARATLARI da MEVCUT

YA-207 D **YA-207 D1**

Tavan Askı Aparatları



Tekli-İkili Krom



İSTENİLEN ÖLÇÜ ve ŞEKİLLERDE
ÇERÇEVE YAPILIR

UYGULAMA ŞEKLİ ;
İÇ MEKAN, ASKI APARATLARI İLE SARKIT,
TAVAN-DUVARA VİDA İLE SABİTLEYEREK



45 DERECE AÇI İLE KESİLİP, KARE-DİKDÖRTGEN GİBİ
DEKORATİF ŞEKİLLERDE ÇERÇEVE ÜRETİLEBİLİR

İstenilen ölçülerde kesim yapılır - İstenilen renge boyanır

All cutting dimensions and surface coatings can be done according to requirements

YA-218

Alm. Lineer Kasa

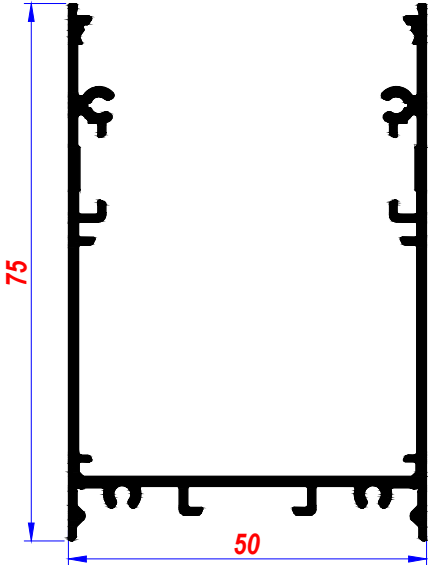

İSTENİLEN RENKDE ÜRETİLİR

Kare, Dikdörtgen, Altıgen gibi, çerçeve üretimine uygun ürün

YA-218 TAKIM, MONTAJ

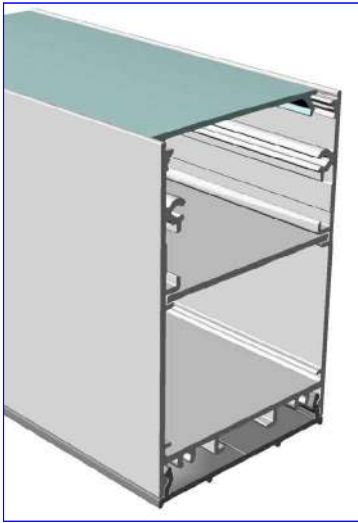

ALM.-PC.PRF. 610 cm

YA-G 50 A

PC.Cam-Difüzör

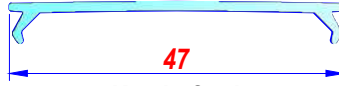

Kumlu Opal

PC.Cam-Difüzör, üstten tatlı sıkı, takılıp çıkartılabilir

YA-218 B

Alm. Kızak Prf.



Kalınlık 1,5 mm

YA-218 T Alm.L Kenar tapa yeni üründür. DİFÜZÖR ile tapa arasında, ışık sızdırmaz. Düz tapaya göre, daha dekoratiftir. İstenilen renge boyanabilir

YA-205 D

Alm. Prf. (Duvar Montaj)

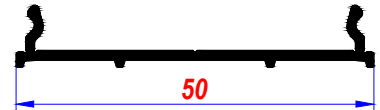

Ürün, 5 cm kısa parçalar halinde bağlantı klipsi gibi de kullanılır

YA-218 T

Alm. L Ken.Tapa



İstenilen renkte üretilir Kalınlık 1,5 mm

Difüzör ile tapa arasında, ışık sızdırmaz.

Lineer ürünlerde, Yeni L TAPA

YA-207 D

Tavan Askı Aparatı



standart tel 1,5 mt

Tekli Krom

YA-207 D1

Tavan Askı Aparatı



özel tel ölçüsü sipariş edilebilir

İkili-Krom

YA-207 E2

Askı Teli Tutucu



Gen.16,3 mm

Kalınlık 2,5 mm

MONTAJ

TAVAN-DUVAR

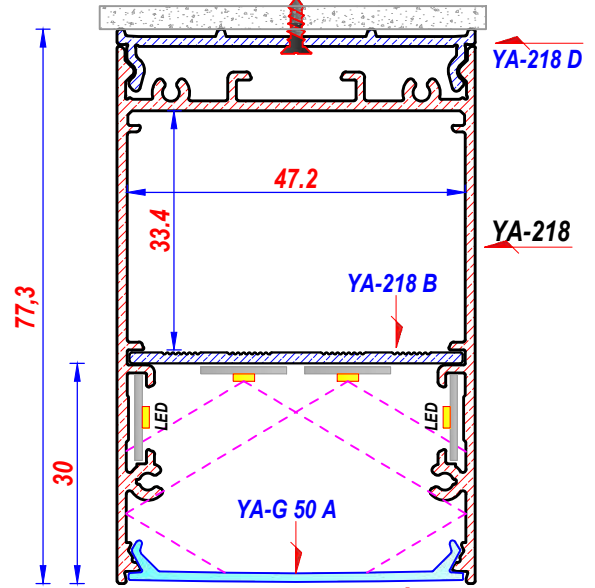

UYGULAMA ŞEKLİ ;

İÇ MEKAN, ASKI APARATLARI İLE SARKIT, TAVAN-DUVARA VİDA İLE SABİTLEYEREK

YA-218 D Kullanılmadan, tavan veya duvara, direkt YA-218 i vidalayarak, uygulanır. isteğe göre, YA-218 D Tavana vidayla sabitlenir, daha sonra ana kasaya, sıkı geçme takılır.

Z UYGULAMASI



YA-207 E

Dikey 90° Metal Köşe



Gen.16,3 mm

Kalınlık 2,5 mm

YA-207 E1

Yatay 90° Metal Köşe



Gen.16,3 mm

Kalınlık 2,5 mm

YA-207 E3

Metal Düz Gönye



Gen.16,3 mm

Uz.110 mm Kalınlık 2,5 mm

METAL İÇ KÖŞE APARATLARI



GENİŞLİK 12 mm

YA-218 K1 30° Metal köşe
YA-218 K2 45° Metal köşe
YA-218 K3 60° Metal köşe
YA-218 K4 90° Metal köşe

YA-218 K5 120° Metal köşe
YA-218 K6 135° Metal köşe
YA-218 K7 150° Metal köşe

İstenilen ölçülerde kesim yapılır - İstenilen renge boyanır

All cutting dimensions and surface coatings can be done according to requirements

ÇOK YÖNLÜ LİNEER AYDINLATMA KASASI

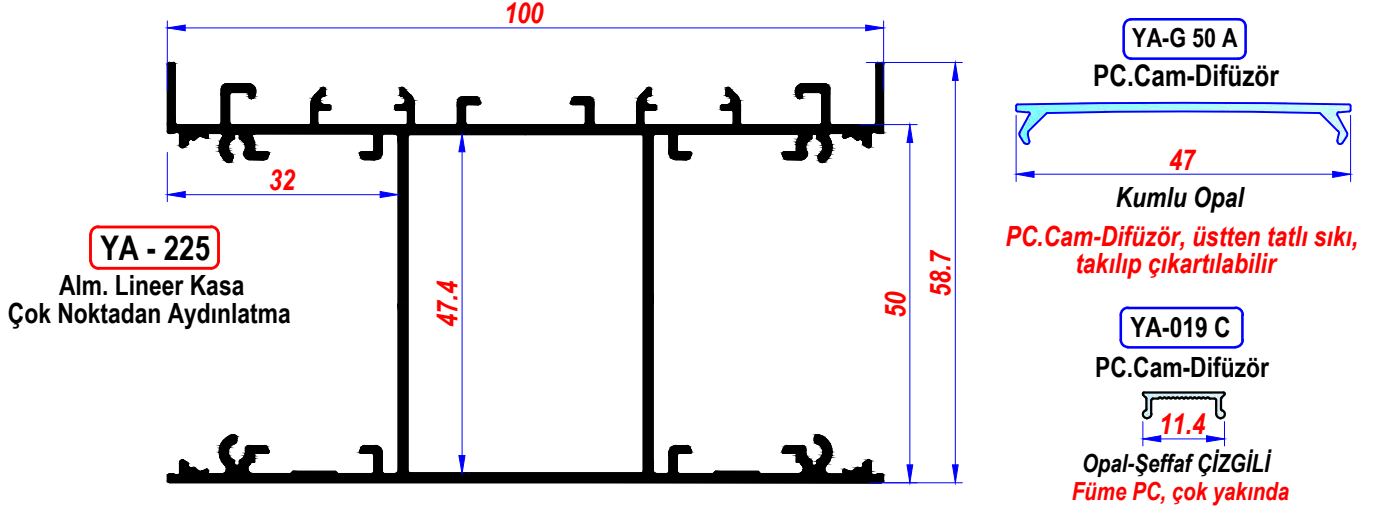

YA-225 ALM. KASA VE AKSESUARLARI

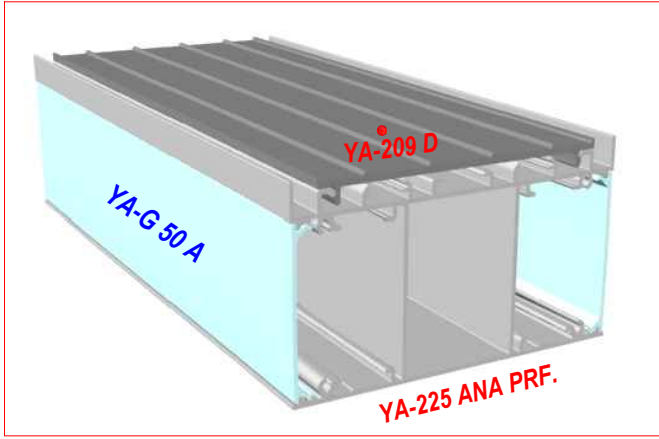

Alüminyum ve PC. Profiller 610 cm

UYGULAMA ALANLARI ;

İÇ MEKAN, ASKI APARATLARI İLE SARKIT,
TAVAN-DUVARA VİDA İLE SABİTLEYEREK

Sarkit aydınlatma, dört noktadan
Tavana montajda, iki noktadan
Aydınlatmaya uygun, yeni ürün

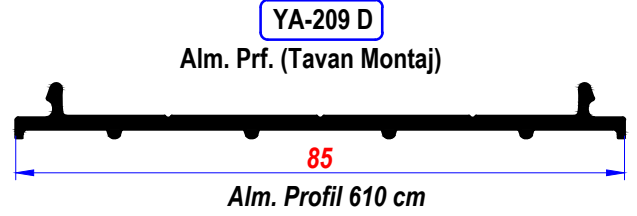

YA-209 D
Alm. Prf. (Tavan Montaj)

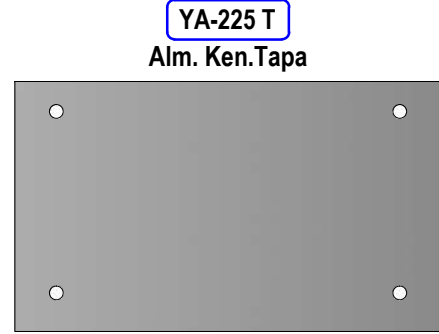

YA-225 T
Alm. Ken.Tapa
Alm. Lazer Kenar Tapa, 1,5 mm

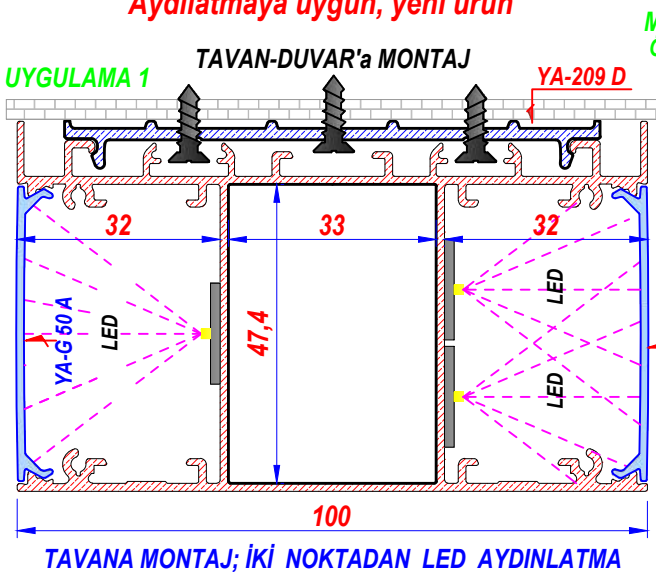

TAVANA MONTAJ; İKİ NOKTADAN LED AYDINLATMA

MONTAJ
Ölçsüz

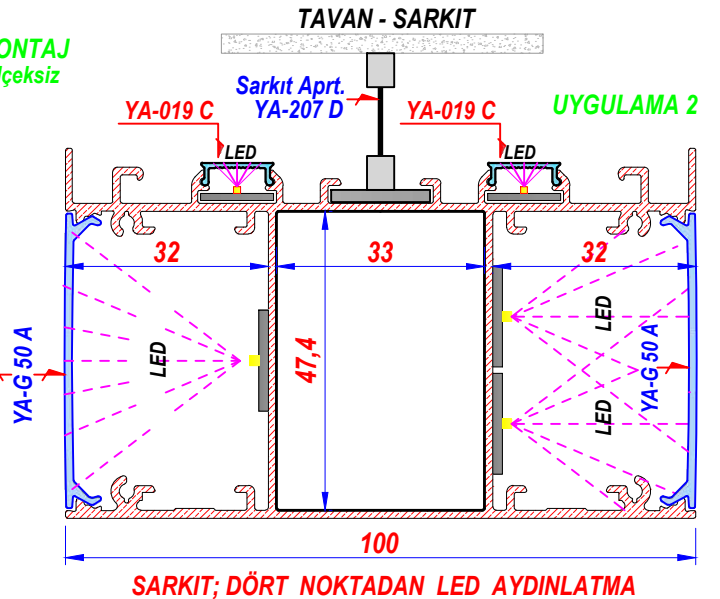

SARKIT; DÖRT NOKTADAN LED AYDINLATMA

İstenilen ölçülerde kesim yapılır - İstenilen renge boyanır
All cutting dimensions and surface coatings can be done according to requirements

İKİ YÖNLÜ LİNEER AYDINLATMA PROFİLİ

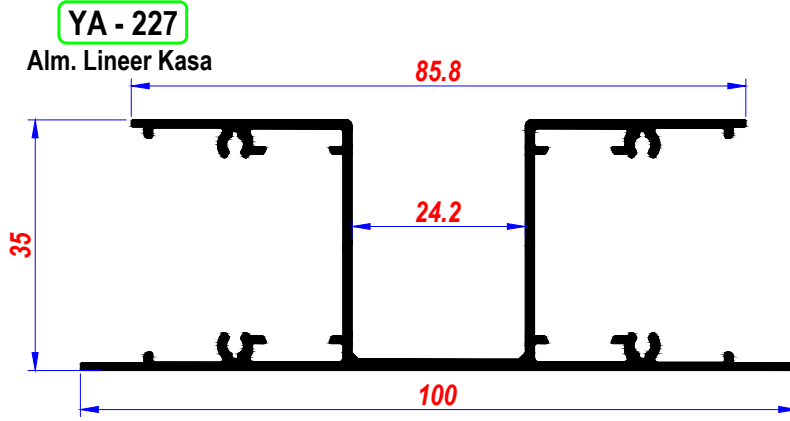

YA-227 ALM.PRF. 610 cm

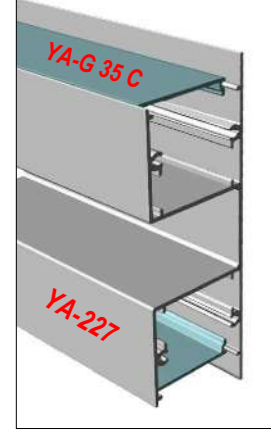

YENİ

YA-G 35 C

PC.Cam-Difüzör

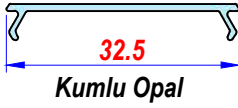

PC.Cam-Difüzör, üstten tatlı sıkı,
takılıp çıkartılabilir

YA-227 D

Tavan Bağ. Aparatı

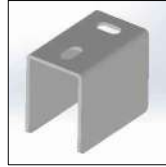

YA-227 T

Alm. Ken.Tapa

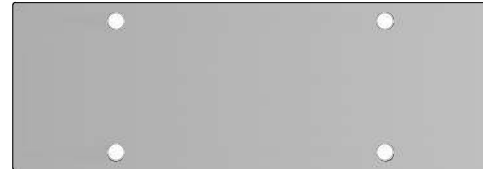

Sarkıt İçin Kullanılan ASKI Aparatları

YA-207 D

Tavan Askı Aparatı



YA-207 D1

Tavan Askı Aparatı



Standart tel: 1,5 mt
özel tel ölçüsü sipariş edilebilir

UYGULAMA ALANLARI ;

İÇ MEKAN, ASKI APARATLARI İLE SARKIT,
TAVAN ve DUVARA VİDA İLE SABİTLEYEREK uygulanır.

UYGULAMA 1

TAVAN-DUVAR'a MONTAJ

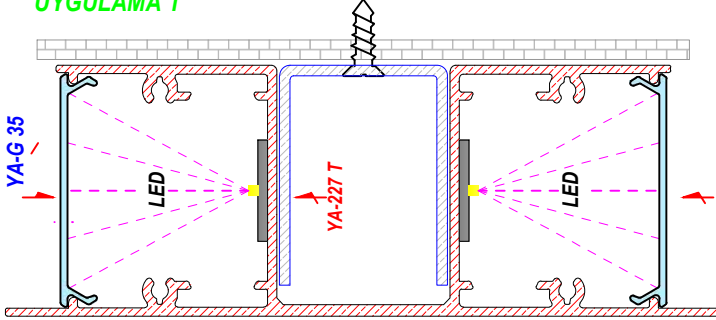

TAVANA - DUVARA MONTAJ; İKİ NOKTADAN LED AYDINLATMA
Yatay ve Dikey uygulamaya uygundur

TAVAN - SARKIT

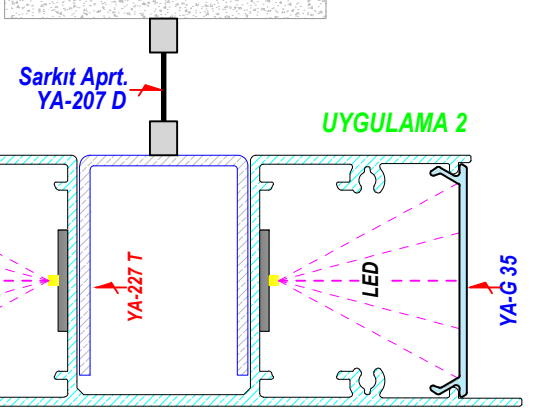

SARKIT; İKİ NOKTADAN LED AYDINLATMA



İÇ MEKAN, YATAY UYGULAMA

Farklı Derecelerde Metal Köşe Kullanılarak,
Dekoratif Şekillerde Çerçeve Üretilebilir.

METAL İÇ KÖŞE APARATLARI



GENİŞLİK 12 mm

YA-218 K1 30° Metal köşe

YA-218 K2 45° Metal köşe

YA-218 K3 60° Metal köşe

YA-218 K4 90° Metal köşe

YA-218 K5 120° Metal köşe

YA-218 K6 135° Metal köşe

YA-218 K7 150° Metal köşe

SÜRÜLEBİLİR DİFÜZÖRLÜ LİNEER PROFİL VE AKSESUARLARI

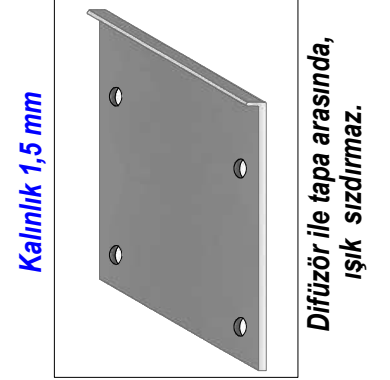
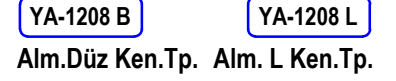
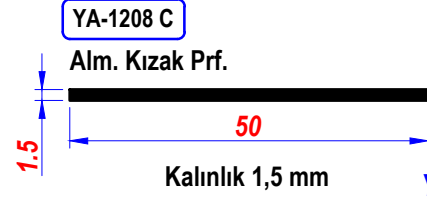
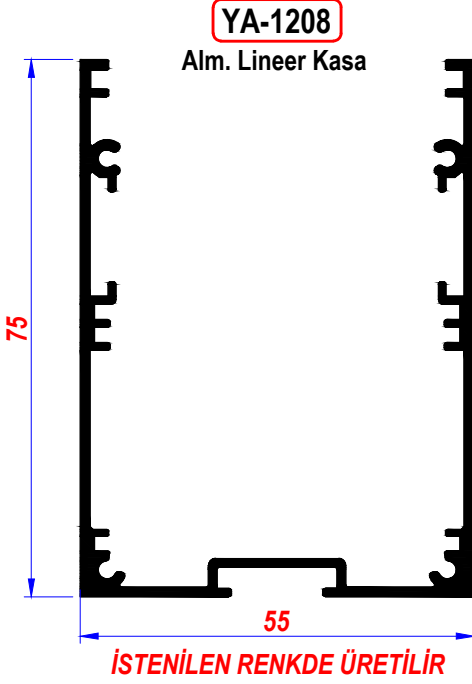

Lineer ürünlerde, Yeni L TAPA

YA-1208 L Alm. ken. tapa yeni üründür.
Difüzör ile tapa arasında, ışık sızdırmaz.
Düz tapaya göre, daha dekoratiftir.
İstenilen renge boyanabilir

YA-207 D

Tavan Askı Aparatı



Tekli-Krom

özel tel ölçüsü sipariş edilebilir
standart tel uzunluğu 1,5 mt

YA-207 D1

Tavan Askı Aparatı



İkili-Krom

YA-207 E

Dikey 90° Metal Köşe



GENİŞLİK 16,3 mm

YA-207 E1

Yatay 90° Metal Köşe



GENİŞLİK 16,3 mm

YA-207 E2

Metal Askı Teli Tutucu



GENİŞLİK 16,3 mm

UYGULAMA ŞEKLİ ;
İÇ MEKAN, ASKI APARATLARI İLE SARKIT,
TAVAN-DUVARA VİDA İLE SABİTLEYEREK

YA-1208 ALM. ve AKSESUARLARI

TAVAN SARKIT UYGULAMA

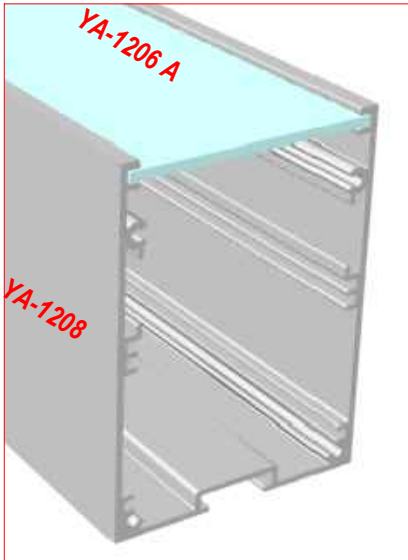

Alm. Prf. 610 cm-Akrilik Difüzör 240 cm

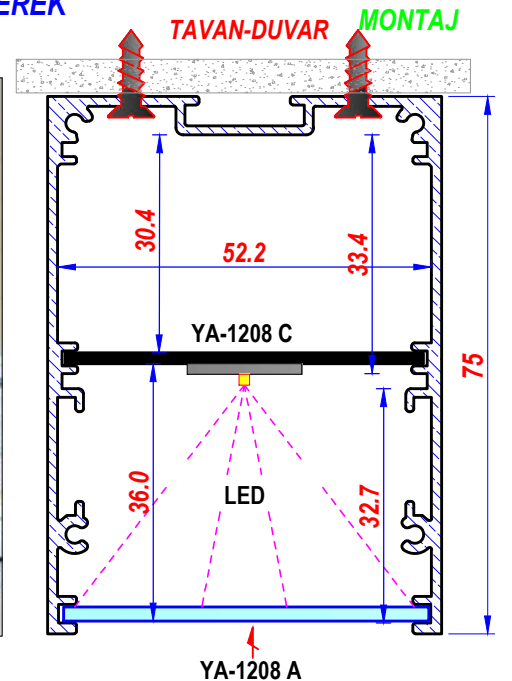

İstenilen ölçülerde kesim yapılır - İstenilen renge boyanır

All cutting dimensions and surface coatings can be done according to requirements

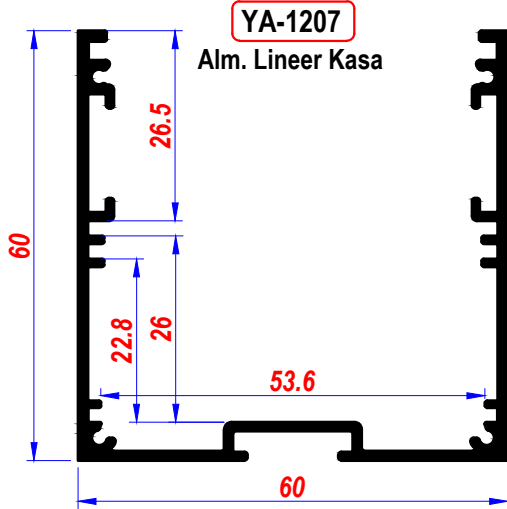

YA-1207 ALM. ve AKSESUARLARI

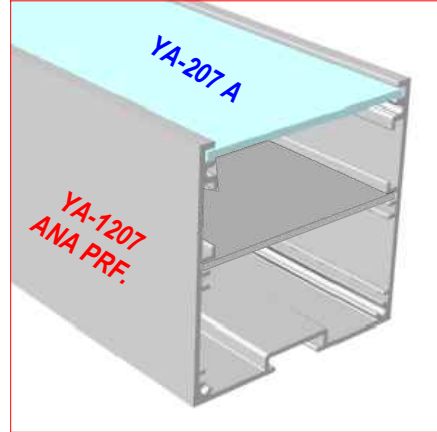

Alm.Prf. 610 cm-Akrilik Difüzör 240 cm

İSTENİLEN ÖLÇÜLERDE AÇILI VE DÜZ KESİM YAPILIR
İSTENİLEN RENKDE ÜRETİLİR

YA-207 A

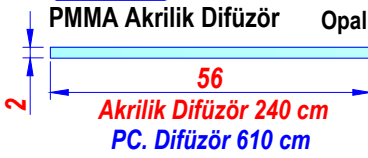

YA-207 C

Alm. Kızak Prf.



YA-1207 T

Alm. Kenar Tapa

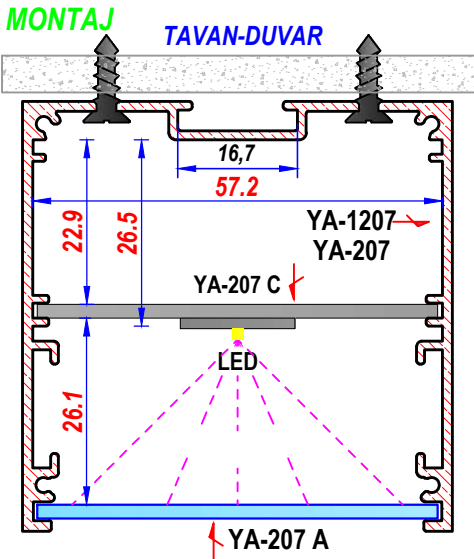
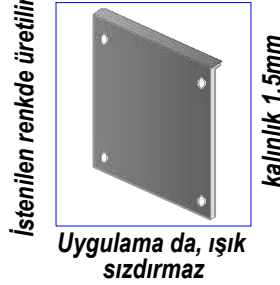

45 DERECE KESİM - KARE UYGULAMASI

YA-207 D

Tavan Askı Aparatı-Tekli



TEKLİ KROM

YA-207 D1

Tavan Askı Aparatı-İkili



İKİLİ KROM

YA-207 TA

Tavan Montaj Aparatı



YA-207 E

Dikey 90° Metal Köşe



Gen.16,3 mm

YA-207 E4

Metal Gönye



Gen.16,3 mm

YA-207 E1

Yatay 90° Metal Köşe



Gen.16,3 mm

YA-207 E5

Yatay 120° Metal Köşe



ALTİGEN

Gen.16,3 mm

YA-207 E2

Askı Teli Tutucu



Sekustur vidalı

Gen.16,3 mm

YA-207 E6

Yatay 135° Metal Köşe



SEKİZGEN

Gen.16,3 mm

YA-207 E3

Metal Düz Gönye



Uz.110 mm

Gen.16,3 mm

YA-207 E7

Yatay 150° Metal Köşe



ONİKİGEN

Gen.16,3 mm

UYGULAMA ŞEKLİ

ASKI APARATLARI İLE SARKIT,
TAVAN-DUVARA VİDA İLE SABİTLEYEREK
YA-1207 AÇILI KESİM YAPILARAK, FARKLI
ŞEKİLLERDE ÇERÇEVE ÜRETİLEBİLİR
METAL KÖŞELER, ALM. LİNEER PROFİLLERE
UYGUN ÜRETİLMİŞTİR

özel tel ölçüsü, sipariş edilebilir

İstenilen ölçülerde kesim yapılır - İstenilen renge boyanır
All cutting dimensions and surface coatings can be done according to requirements

YA-207 BY

Alm. Lineer Kasa
YENİ KASA

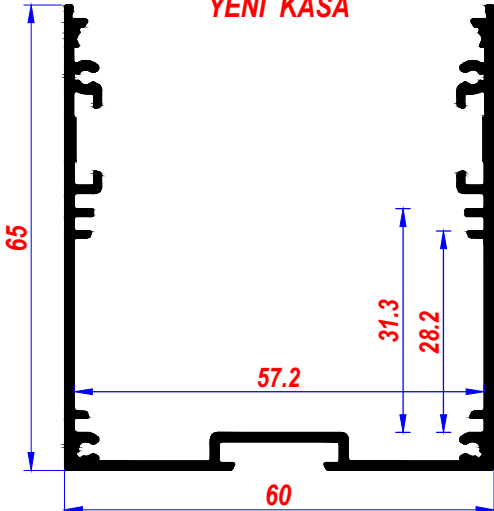

Üstten takılıp çıkartılabilen yeni PC difüzör
Kare, Dikdörtgen, Altıgen gibi, çerçeve
üretimine uygun ürün

YA-220 C

PC.Cam-Difüzör



Kumlu Opal YA-207 BY ye uygun

Yeni kasaya uygun PC.Cam-Difüzör,
üstten tatlı sıkı takılıp çıkartılabilir

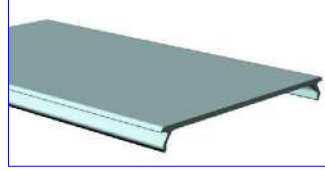

PC.DİFÜZÖR 610 cm

YA-207 C

Alm. Kızak Prf.



Kalınlık 1,5 mm

YA-207 BY-1

Alm. Lineer Prf.

SÜRÜLEBİLİR DİFÜZÖRLÜ
ESKİ KASA



Akrilik Difüzör 240 cm
PC. Difüzör 610 cm

Sürülebilir akrilik difüzör 240 cm
Çerçeve yapımına uygun değildir.

YA-207 BY

YA-220 C

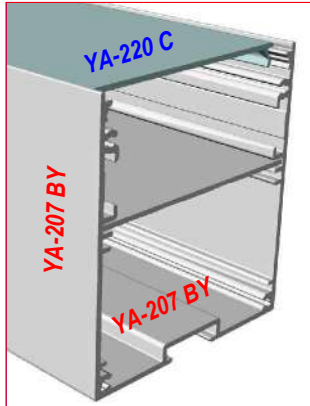

Alm.Prf. PC.Difüzör 610 cm

YA-207 BY T

Alm. L Ken.Tapa

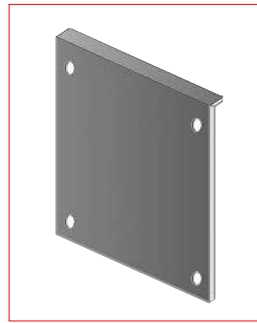

Uygulamada, ışık
sızdırmaz

YA-207 D

Tavan Askı Aparatı



standart tel 1,5 mt

Tekli Krom

YA-207 D1

Tavan Askı Aparatı



İkili-Krom

YA-207 BY-1

YA-207 A

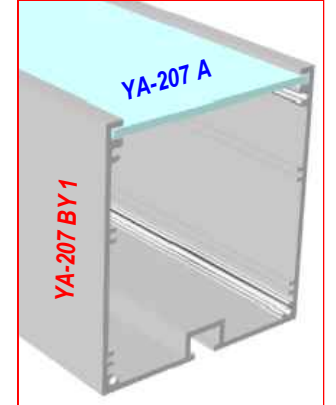

Alm.Prf. 610 cm
Akrilik Difüzör 240 cm

TAVAN-DUVAR

60.0

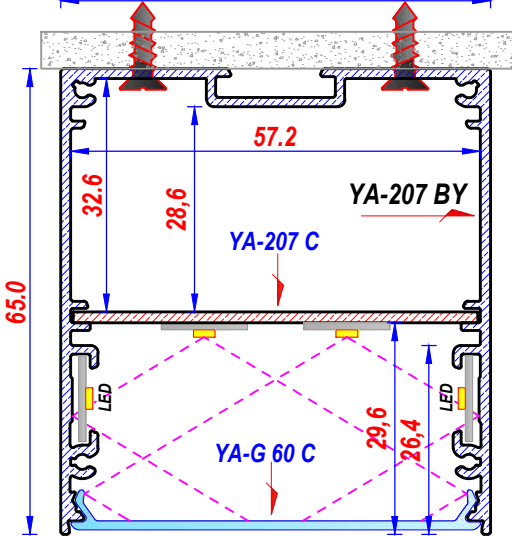

İç mekan, askı aparatları ile sarkıt,
Tavan ve duvara sabitleyerek uygulanabilir

YA-218 T Alm.L Kenar tapa yeni üründür.
DİFÜZÖR ile tapa arasında, ışık sızdırmaz.
Düz tapaya göre, daha dekoratiftir.
İstenilen renge boyanabilir

Bütün Bağlantı Aparatları stokludur



İstenilen şekil ve açılarda çerçeve üretilir

METAL İÇ KÖŞE APARATLARI



GENİŞLİK 12 mm

- YA-218 K1 30° Metal Köşe
- YA-218 K2 45° Metal Köşe
- YA-218 K3 60° Metal Köşe
- YA-218 K4 90° Metal Köşe
- YA-218 K5 120° Metal Köşe
- YA-218 K6 135° Metal Köşe
- YA-218 K7 150° Metal Köşe

İstenilen ölçülerde kesim yapılır - İstenilen renge boyanır

All cutting dimensions and surface coatings can be done according to requirements

YA-220

Alm. Lineer Kasa

İKİ YÖNLÜ LED AYDINLATMA

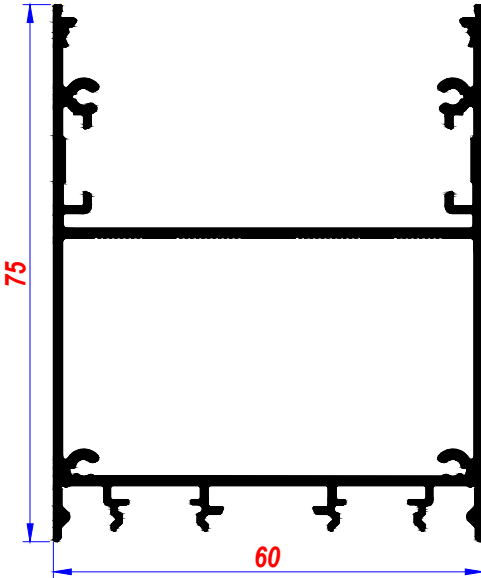

İSTENİLEN RENKDE ÜRETİLİR
Kare, Dikdörtgen, Altıgen gibi, çerçeve
üretimine uygun ürün

YA-220 ALM.PRF. ve AKSESUARLARI

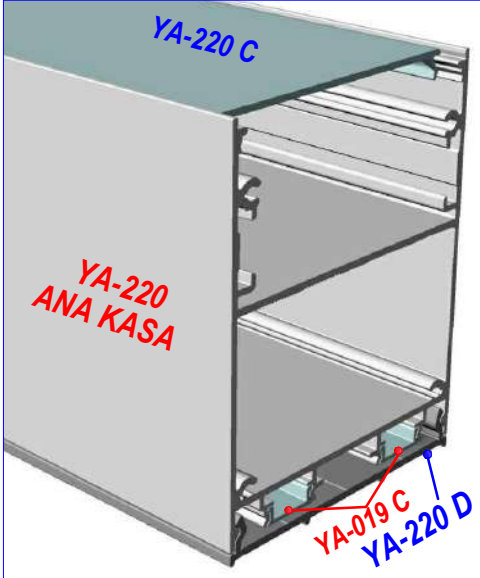

ALM.-PC.PRF. 610 cm

SABİT KIZAKLI

YA-220 C

PC.Cam-Difüzör

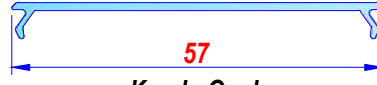

Kumlu Opal

PC.Cam-Difüzör, üstten tatlı sıkı,
takılıp çıkartılabilir

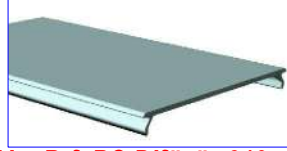

Alm.Prf. PC.Difüzör 610 cm

Sarkıt uygulamalarda, aşağı ve
yukarı aydınlatma imkanı sunar
DİFÜZÖR ile tapa arasında, ışık sızdırmaz.
Düz tapaya göre, daha dekoratiftir.
İstenilen renge boyanabilir

YA-220 D

Alm. Prf. (Duvar Montaj)



ALM. PRF. 610 cm

YA-220 T

Alm. L Ken.Tapa



İstenilen renkte üretilir
Kalınlık 1,5 mm

Difüzör ile tapa arasında,
ışık sızdırmaz.

Lineer ürünlerde, Yeni L TAPA

YA-019 C

PC. Difüzör



Opal-Şeffaf ÇİZGİLİ
Füme PC, çok yakında

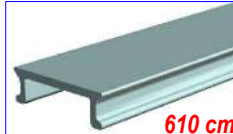

610 cm

Sarkıt üründe Kullanılır

YA-207 D

Tavan Askı Aparatı



Standart tel 1,5 mt

özel tel ölçüsül sipariş edilebilir

Tekli Krom

YA-207 D1

Tavan Askı Aparatı



İkili Krom

MONTAJ

TAVAN-DUVAR

YA-220 D

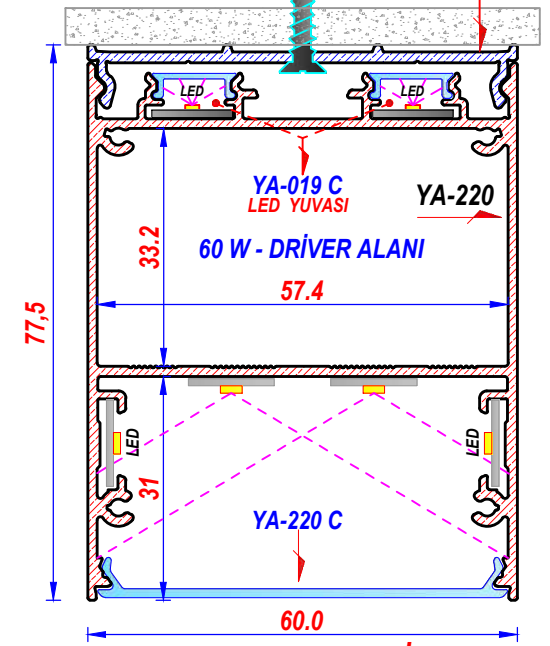

UYGULAMA ŞEKLİ

İç mekan, askı aparatları ile sarkıt,
Tavan ve duvara sabitleyerek uygulanır
ALTIGEN UYGULAMASI

KARE UYGULAMASI

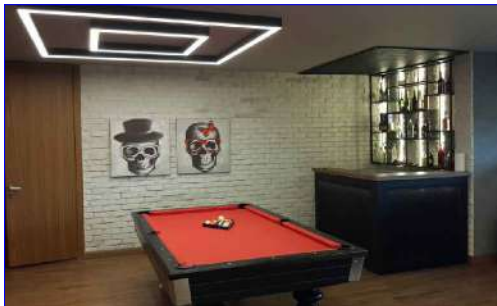

İSTENİLEN ÖLÇÜLERDE
AÇILI KESİM YAPILIR



İstenilen ölçülerde kesim yapılır - İstenilen renge boyanır

All cutting dimensions and surface coatings can be done according to requirements

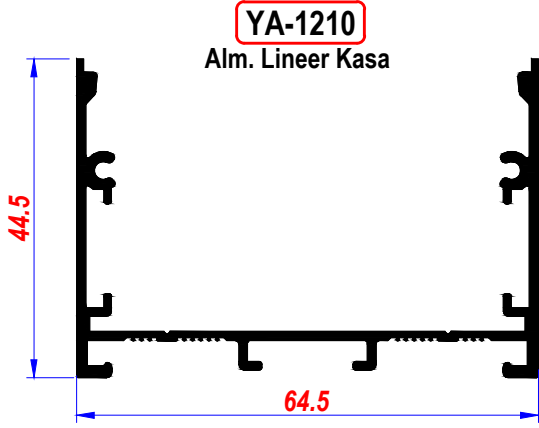

İSTENİLEN RENKTE ÜRETİLİR
İSTENİLEN ÖLÇÜLERDE AÇILI VE DÜZ KESİM YAPILIR

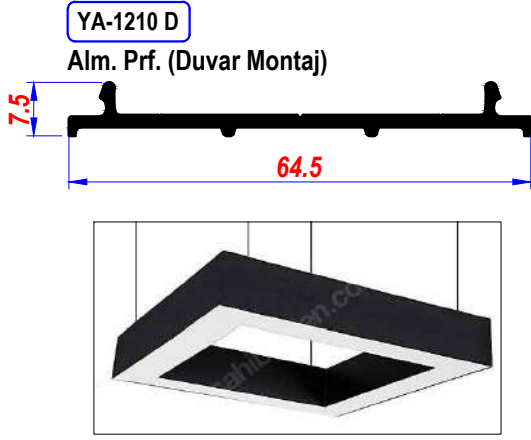

UYGULAMA ALANLARI ;

İÇ MEKAN, ASKI APARATLARI İLE SARKIT,
TAVAN-DUVARA VİDA İLE SABİTLEYEREK

* YA-1210 D kullanılmadan, Tavan veya duvara,
vidayla sabitlenerek kullanılabilir
İsteğe göre; YA-1210 D, Tavan veya duvara vidayla sabitlenir.
Daha sonra ana kasa, sıkı geçme takılır

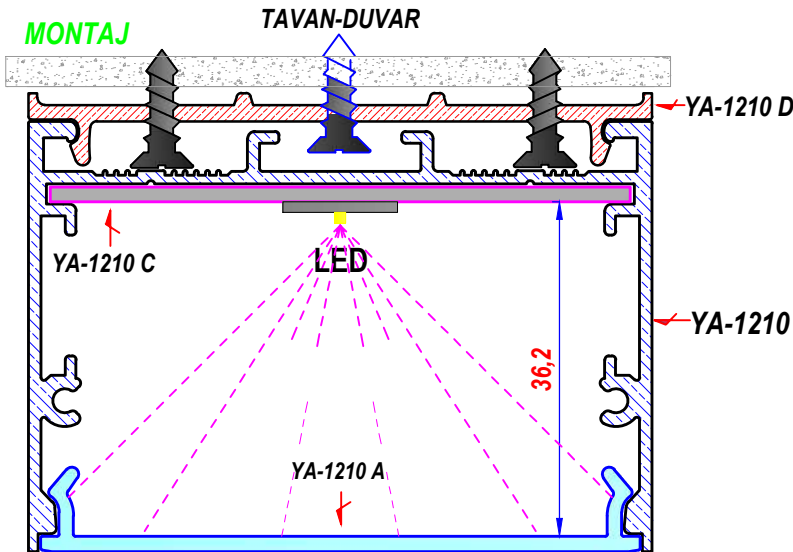

45 DERECE AÇI İLE KESİLİP, KARE-DİKDÖRTGEN GİBİ
DEKORATİF ŞEKİLLERDE ÇERÇEVE ÜRETİLEBİLİR

İstenilen ölçülerde kesim yapılır - İstenilen renge boyanır

All cutting dimensions and surface coatings can be done according to requirements

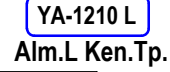
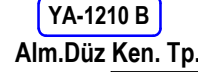
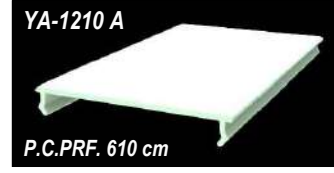
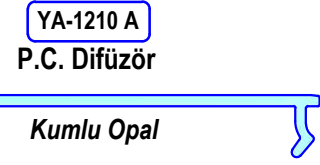

İstenilen renkte üretilir
Kalınlık 1,5 mm

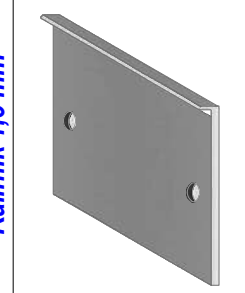

Difüzör ile tapa arasında,
ışık sızdırmaz.

Lineer ürünlerde, Yeni L TAPA

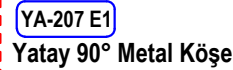
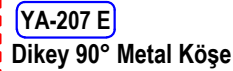
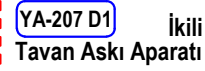
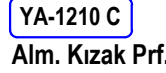

YA-1210 ALM.PRF. ve AKSESUARLARI
Alm.Prf. PC.Difüzör 610 cm

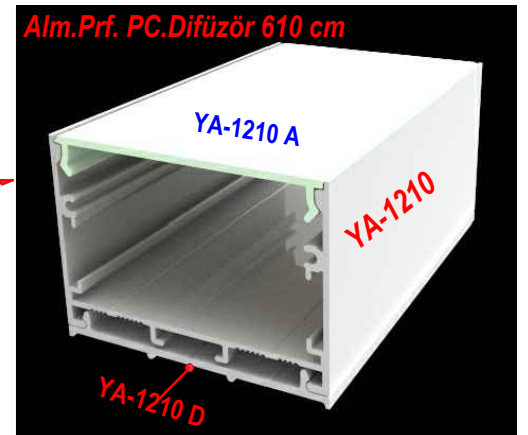

İSTENİLEN ÖLÇÜLERDE ÇERÇEVE YAPILIR

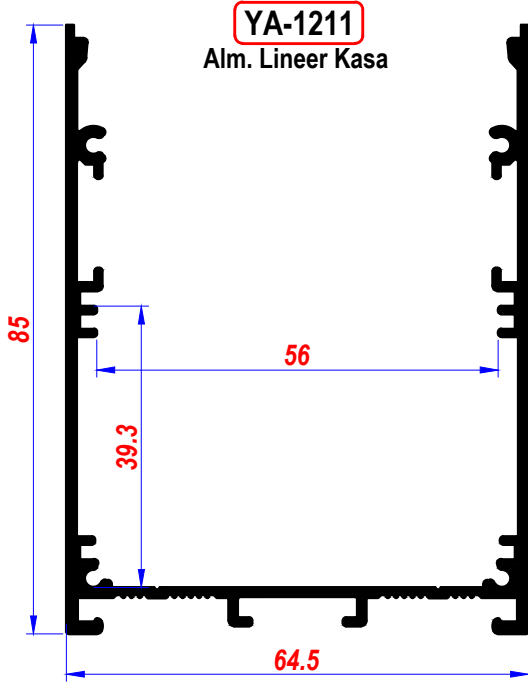

YA-1211
Alm. Lineer Kasa

YA-1210 A
P.C. Difüzör

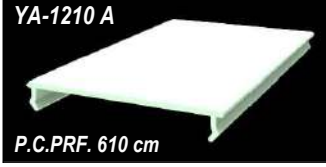

YA-1210 D
Alm. Prf.
Tavan Montaj

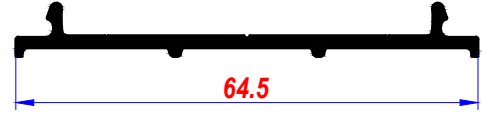

YA-1210 D ALM.PRF. 610 cm

YA-1211 B
Alm. Düz. Ken. Tp.

YA-1211 L
Alm. L Ken. Tp.

İstenilen renkte üretilir
Kalınlık 1,5 mm

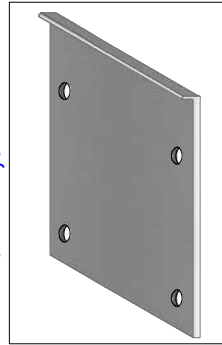

Difüzör ile tapa arasında,
ışık sızdırmaz.

YA-1210 C

Alm. Kızak Prf.

Kalınlık 1,5 mm

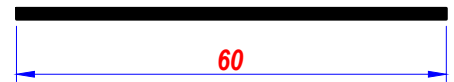

YA-207 E2

Metal Askı Teli Tutucu



YA-207 D Tekli
Tavan Askı Aparatı



YA-207 D1 İkili
Tavan Askı Aparatı



YA-207 E
Dikey 90° Metal Köşe



YA-207 E1
Yatay 90° Metal Köşe



Lineer ürünlerde, Yeni L TAPA

UYGULAMA ALANLARI ;

İÇ MEKAN, ASKI APARATLARI İLE SARKIT,
TAVAN-DUVARA VİDA İLE SABİTLEYEREK

45 DERECE KESİLİP, 90 DERECE KARE-DİKDÖRTGEN
GİBİ DEKORATİF ARMATÜRLER de ÜRETİLEBİLİR

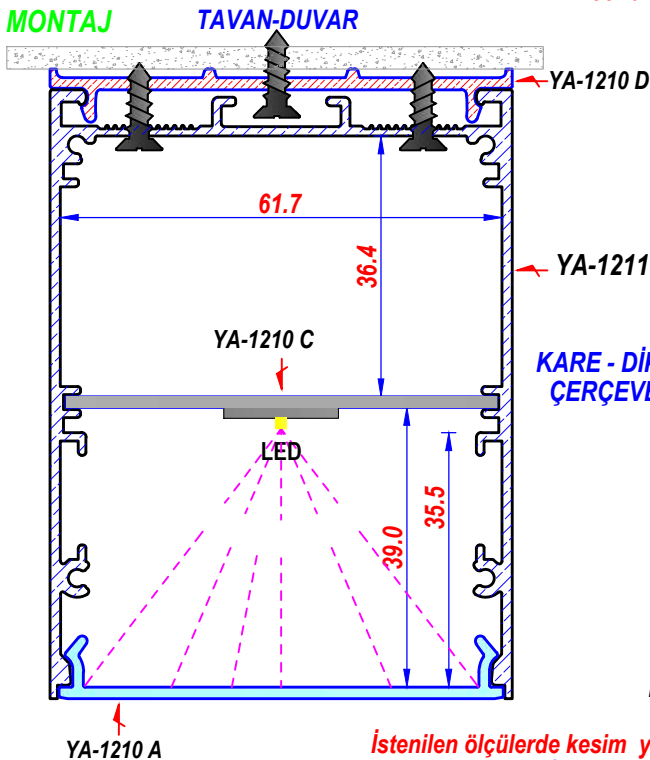

KARE - DİKDÖRTGEN
ÇERÇEVE YAPILIR

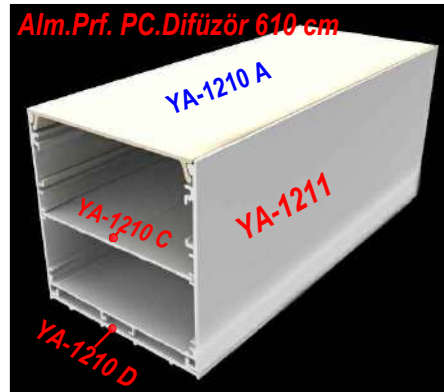

YA-1210 D kullanılmadan, Tavan veya duvara,
vidayla sabitlenerek de kullanılabilir

İsteğe göre; YA-1210 D, Tavan veya duvara vidayla sabitlenir.

İstenilen ölçülerde kesim yapılır - İstenilen renge boyanır

All cutting dimensions and surface coatings can be done according to requirements

SIVA ÜSTÜ-SARKIT, İKİ YÖNLÜ LİNEER AYDINLATMA

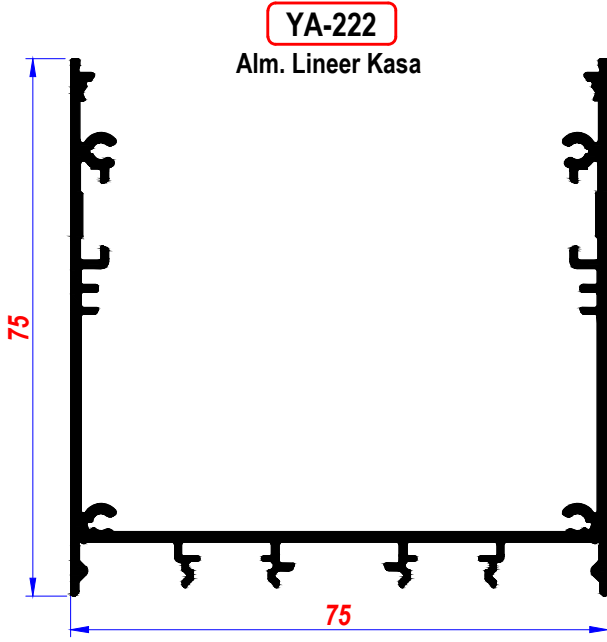

İSTENİLEN RENKDE ÜRETİLİR
Kare, Dikdörtgen, Altıgen gibi, çerçeve
üretimine uygun ürün

YA-222 ALM.PR.F. ve AKSESUARLARI

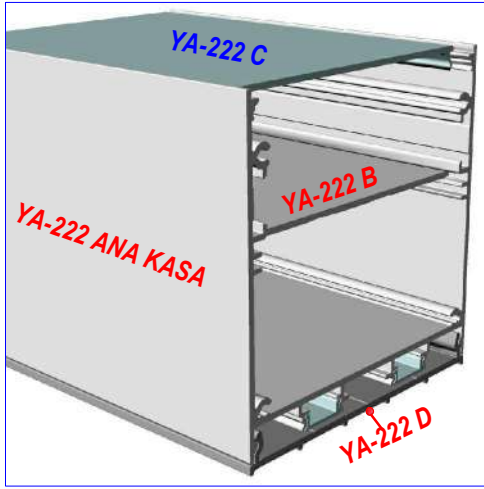

Alm.Pr.f. PC.Difüzör 610 cm

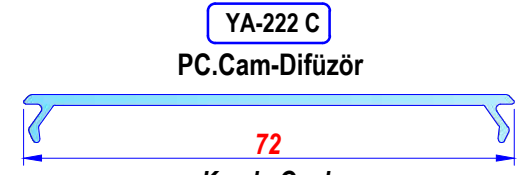

PC.Cam-Difüzörler, üstten tatlı sıkı,
takılıp çıkartılabilir

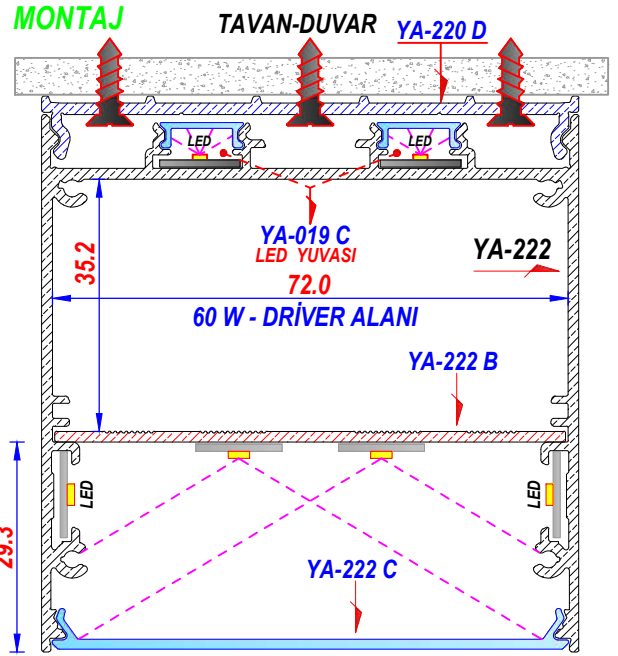
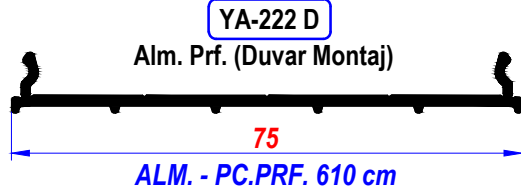

UYGULAMA ŞEKLİ

İç mekan, askı aparatları ile sarkıt,
Tavan ve duvara direkt vida ile sabitleyerek,
isteğe göre, YA-220 D Tavana vidayla sabitlenir,
daha sonra ana kasaya, sıkı geçme takılır.
Aydınlatma iki yönlüdür.Sarkıtta, YA 019 C,
tavanı aydınlatır

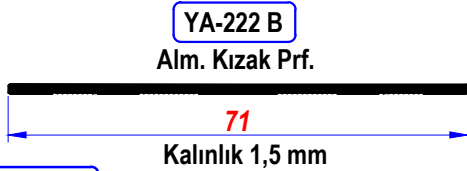

özel tel ölçüsü sipariş edilebilir-Standart tel: 1,5 mt



İstenilen renkte üretilir
Kalınlık 1,5 mm



İstenilen ölçülerde kesim yapılır - İstenilen renge boyanır
All cutting dimensions and surface coatings can be done according to requirements

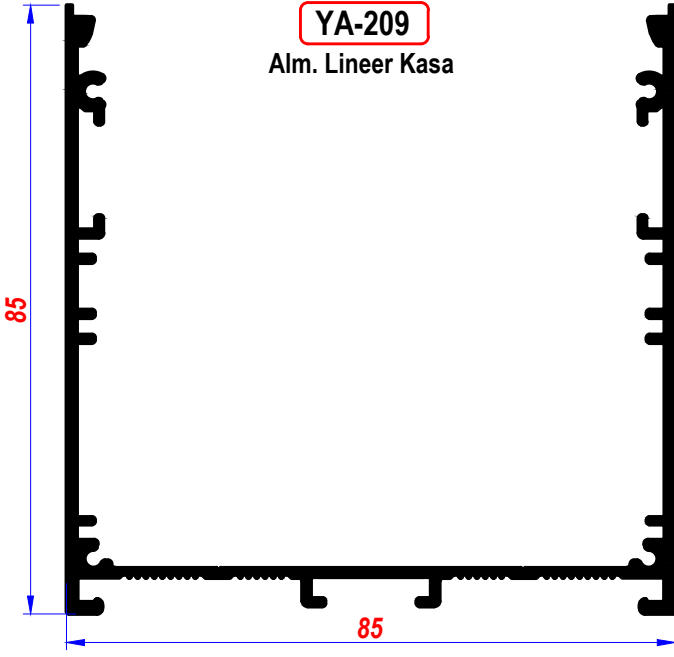

YA-209
Alm. Lineer Kasa

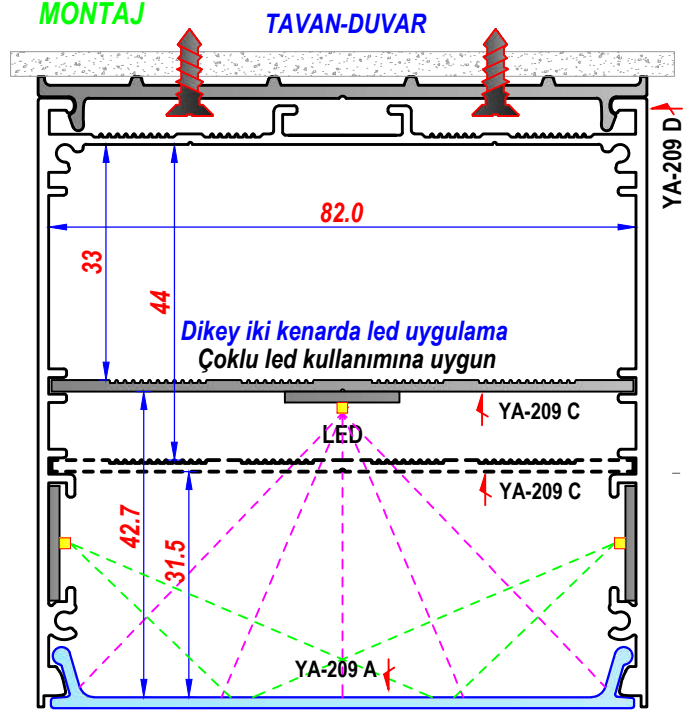

İsteğe göre tavan montaj profiliyle birlikte kullanılır

Kare-Dikdörtgen uygulamasına uygun ürün

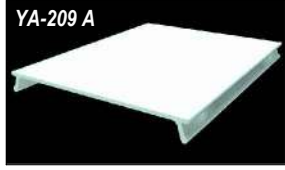
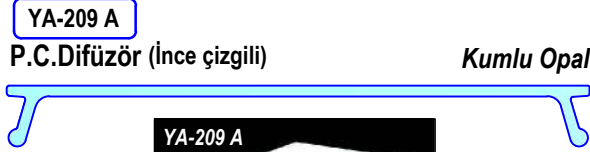

PC.DİFÜZÖR-ALM.PROF. 610 cm

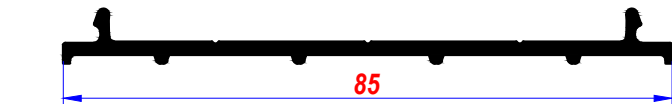
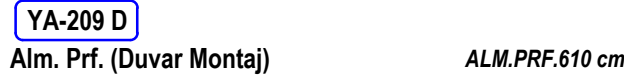

Tavan-Duvar Montaj Prf.

YA-207 D	Tekli
Tavan Askı Aparatı	
YA-207 D1	İkili
Tavan Askı Aparatı	
YA-207 E	
Dikey 90°Metal Köşe	
YA-207 E1	
Yatay 90°Metal Köşe	
YA-207 E 2	
Metal askı teli tutucu	



KARE UYGULAMASI

İSTENİLEN ÖLÇÜLERDE ÇERÇEVE YAPILIR

YA-209 B
Alm.Ken.Tp.



Kalınlık 1,5 mm

İstenilen renkte üretilir

YA-209 T
Alm.L Ken.Tp.

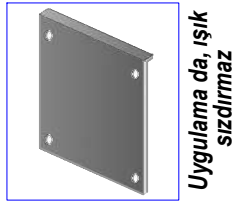

Uygulama da, ışık sızdırmaz

İÇ MEKAN, ASKI APARATLARI İLE SARKIT, YA-209 D kullanılmadan, Tavan veya duvara, vidayla sabitlenerek kullanılabilir

YA-209 ALM.PROF. ve AKSESUARLARI

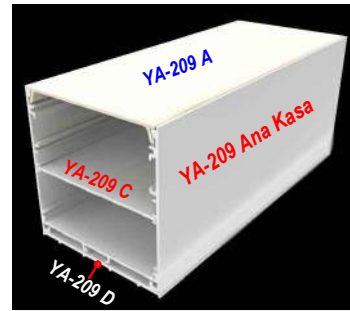

Alm.Pr. PC.Difüzör 610 cm

İsteğe göre; YA-209 D, Tavan veya duvara vidayla sabitlenir, daha sonra ana kasa, sıkı geçme takılır

DIKEY METAL İÇ KÖŞE APARATLARI



Genişlik:16 mm

YA-209 K1	30° Metal Köşe
YA-209 K2	45° Metal Köşe
YA-209 K3	60° Metal Köşe
YA-209 K4	90° Metal Köşe
YA-209 K5	120° Metal Köşe
YA-209 K6	135° Metal Köşe
YA-209 K7	150° Metal Köşe

İstenilen ölçülerde kesim yapılır - İstenilen renge boyanır
All cutting dimensions and surface coatings can be done according to requirements

YA-223

Alm. Lineer Kasa
SLİM LİNEER

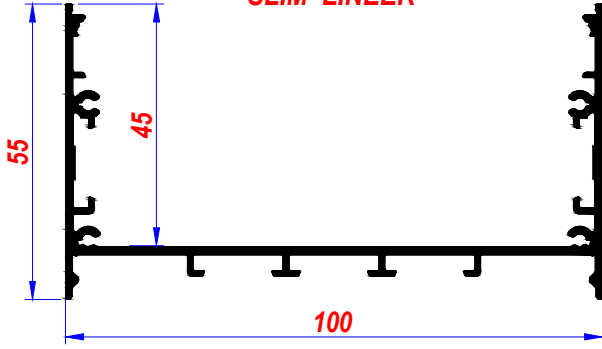

İSTENİLEN RENKTE ÜRETİLİR
Kare, Dikdörtgen, Altgen gibi, çerçeve
üretimine uygun ürün

YA-224 C

PC.Cam-Difüzör

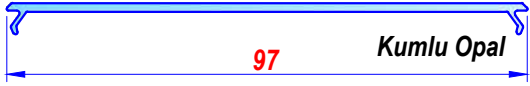

YA-224 D

Alm. Prf. (Duvar Montaj)

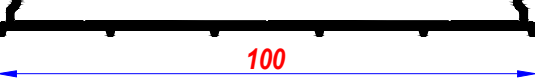

MONTAJ

TAVAN-DUVAR YA-224 D

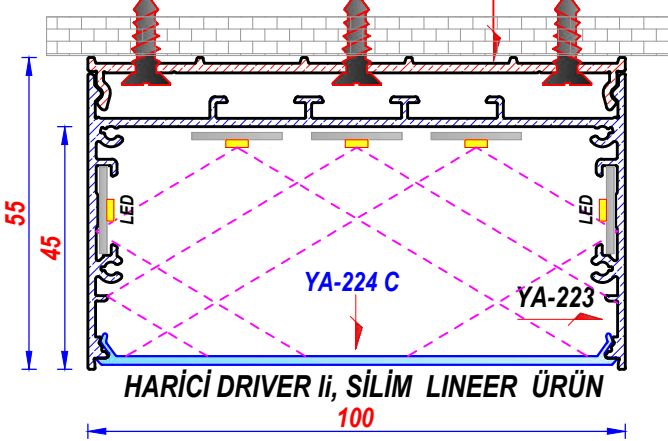

YA-224

Alm. Lineer Kasa

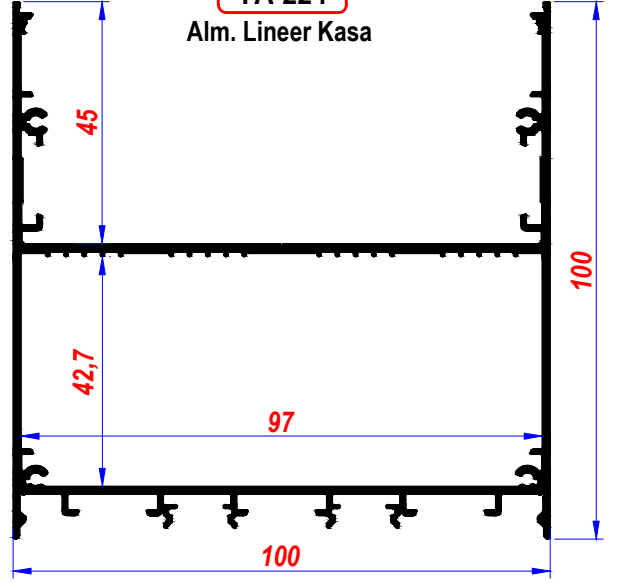

MONTAJ

TAVAN-DUVAR YA-224 D

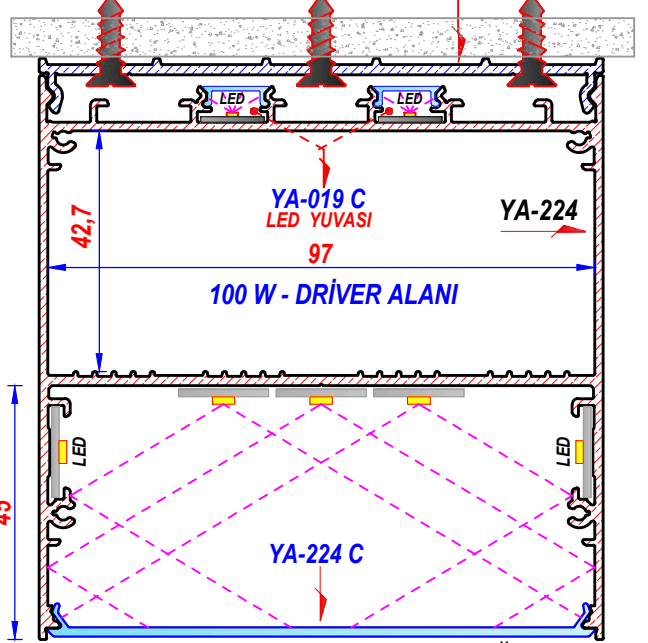

**İç mekan, askı aparatları ile sarkıt,
Tavan ve duvara direkt vida ile sabitleyerek.
isteğe göre, YA-224 D Tavana vidayla sabitlenir,
daha sonra ana kasaya, sıkı geçme takılır.**

YA-223 T

Alm. L Ken.Tapa

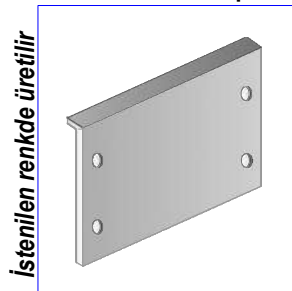

**DİFÜZÖR ile tapa arasında,
ışık sızdırmaz.**

YA-019 C

PC.Cam-Difüzör



Opal-Şeffaf-ÇİZGİLİ
FÜME PC, çok yakında

YA-207 D

Tavan Askı Aparatı



Tekli KROM

özel tel ölçüsü sipariş edilebilir-Standart tel: 1,5 mt

YA-207 D1

Tavan Askı Aparatı



İkili KROM

YA-224 T

Alm. L Ken.Tapa



**Difüzör ile tapa arasında,
ışık sızdırmaz.**

İstenilen ölçülerde kesim yapılır - İstenilen renge boyanır
All cutting dimensions and surface coatings can be done according to requirements

TÜRKİYE DE BU GENİŞLİKTE LİNEER KASA, İLK ve TEK

YA-216

Alm. Lineer Kasa

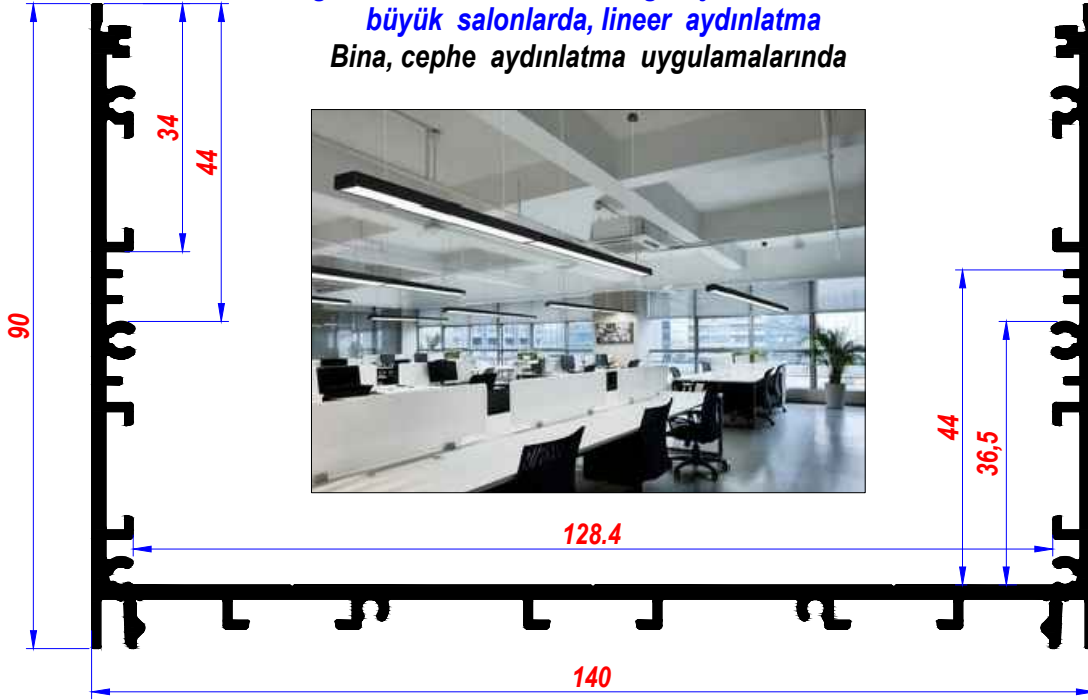

Eğlence, Lobi, showroom gibi yüksek tavanlı
büyük salonlarda, lineer aydınlatma
Bina, cephe aydınlatma uygulamalarında

PC.DİFÜZÖR-ALM.PRF. 610 cm

YA-216 A

Alm. Prf.

Tavan montaj-İç Kızak Prf.



Yüksek tavanlı mekanlarda, tavan montaj profili
İç kızak profili olarak da kullanılabilir

YA-216 B

P.C.Difüzör

OPAL

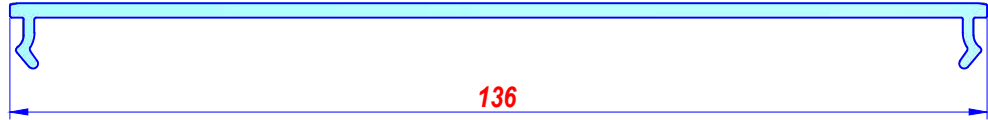

Havaalanı - Stadyum - Tünel - Metro İstasyonu
gibi büyük tesislerde, acil aydınlatma ve
yönlendirme amaçlı kullanımlara uygun ürün

YA-216 C

Alm.Kenar Tapa

YA-216 L

Alm. L Ken. Tp.

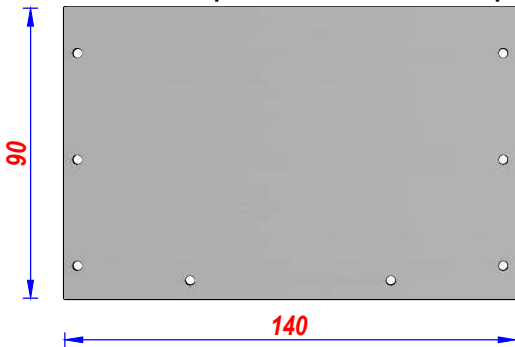

askı aparatları ile, sarkıt olarak da kullanılabilir

TAVAN-DUVAR

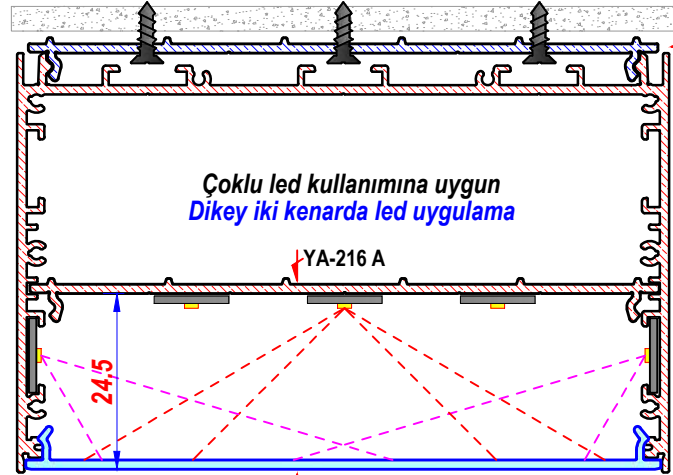

Çoklu led kullanımına uygun
Dikey iki kenarda led uygulama

YA-216 A

YA-216 B

MONTAJ

YA-216 A (Tavan Montaj Prf.)

İstenilen ölçülerde kesim yapılır - İstenilen renge boyanır
All cutting dimensions and surface coatings can be done according to requirements

SIVA ALTI ALÇIPAN, LED AYDINLATMA PROFİL VE AKSESUARLARI

YENİ
YA-ALC 02
Alm. Alçıpan Led Kasa
Her Yöne Esneyebilen Alm. Prf.
TRIMLESS KASA

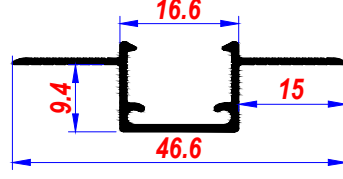

AVZ-001 S
Silikon Difüzör



AVZ-001 PS
Modifiye Silikon

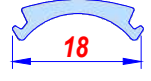

Detay; sayfa 90 da

YENİ
YA-ALC 03
Alm. Alçıpan Led Kasa
YA-001 C
Düz P.C.Difüzör
YA-001 E
Düş.Bom.P.C.Difüzör

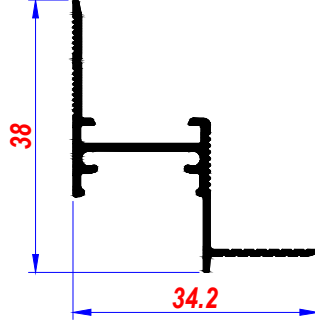

Detay; sayfa 91 de

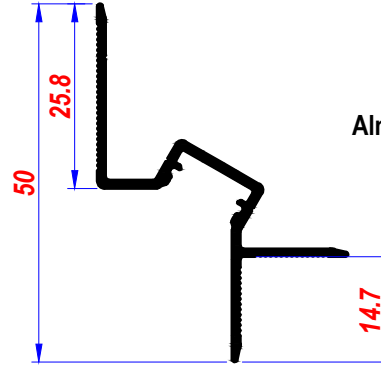

YENİ
YA-ALC 04
Alm. Alçıpan Led Kasa

Detay; sayfa 91 de

YENİ
ALC - 01
Alm. Alçıpan Led Kasa
TRIMLESS KASA

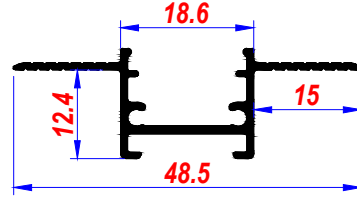

YA-001 C
PC.Difüzör

YA-001 F
PC.Difüzör

YA-001 E
PC.Difüzör

YA-001 A
PC.Difüzör

Detay; sayfa 89 da

ALC-35 S
Alm. Alçıpan Led Kasa
TRIMLESS KASA

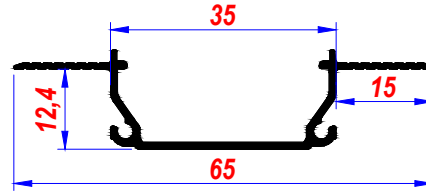

YENİ YA-G 35 C
PC. Difüzör

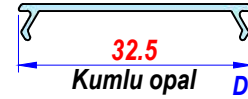

Kumlu opal

Detay; sayfa 92 de

YA-ALC 35
Alm. Alçıpan Led Kasa
TRIMLESS KASA

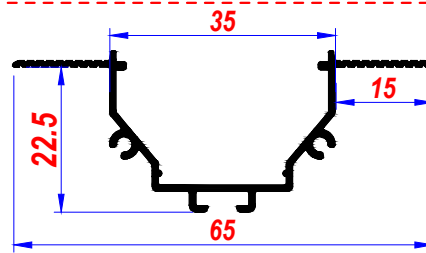

YENİ YA-G 35 C
PC. Difüzör

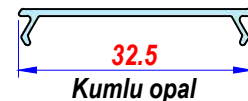

Kumlu opal

Detay; sayfa 94 de

ALC-50 S
Alm. Alçıpan Led Kasa
TRIMLESS KASA

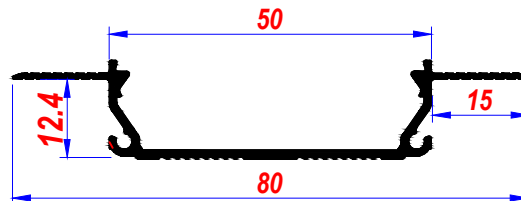

YA-G 50 A
PC.Cam-Difüzör

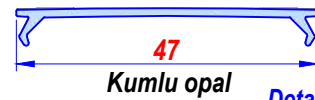

Kumlu opal

Detay; sayfa 93 de

YENİ
YA-ALS 01
Alm.Ledli
Süpürgelik Kasası



Detay; sayfa 47 de

YENİ, SIVA ALTI - ALÇIPAN MİNİK KASA (18,6 mm lik)
TRIMLESS KASA

YENİ ALC - 01

Alm. Alçıpan Led Kasa

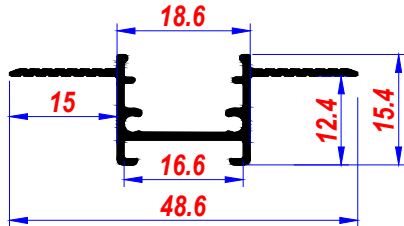

Kolay montaj için, delikli Alm. prof.

SIVA ALTI - TRIMLESS KASA UYGULAMASI



Alm. PC. Profil 610 cm

YA-207 E1

Yatay 90° Metal Köşe



Gen.16,3 mm

60-120-135-150° Gönyeler

YA-001 C

Düz P.C.Difüzör

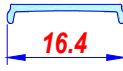

16.4

YA-001 A

U P.C.Difüzör

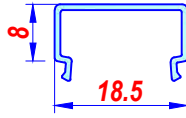

18.5

YA-001 F

Orta Bom.P.C.Difüzör

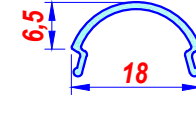

18

YA-207 E3

Metal Düz Gönye

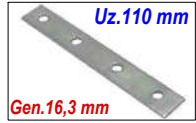

Uz.110 mm

Gen.16,3 mm
Kesintisiz düz uygulamalar için

YA-001 E

Düş.Bom.P.C.Difüzör

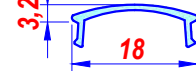

3.2

PC.DİFÜZÖR - ALM.PROF. 610 cm 4 FARKLI PC. DİFÜZÖR SEÇENEĞİ PC.DİFÜZÖR ler OPAL-ŞEFFAF

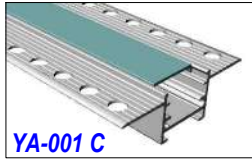

YA-001 C

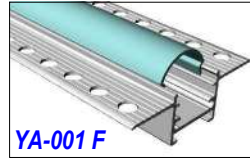
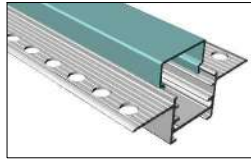

YA-001 F

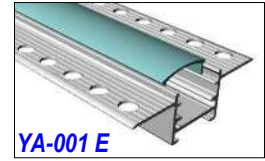

YA-001 E

ALC 01 TC

Alm. Ken.Tapa

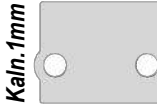

Kalın. 1mm

ALC 01 TA

Alm. Ken.Tapa

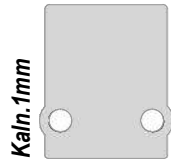

Kalın. 1mm

ALC 01 TF

Alm. Ken.Tapa

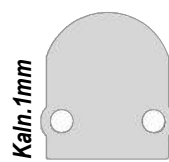

Kalın. 1mm

ALC 01 TE

Alm. Ken.Tapa

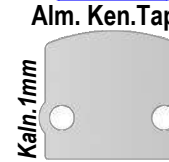

Kalın. 1mm

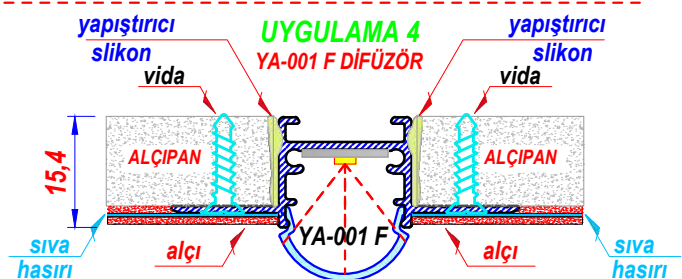
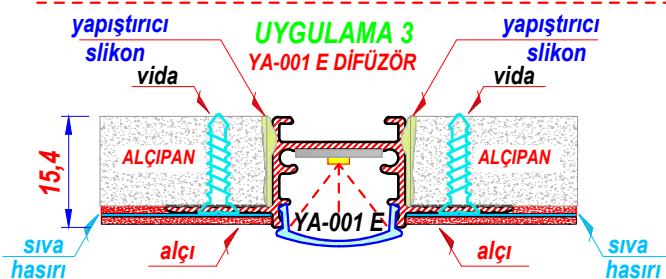
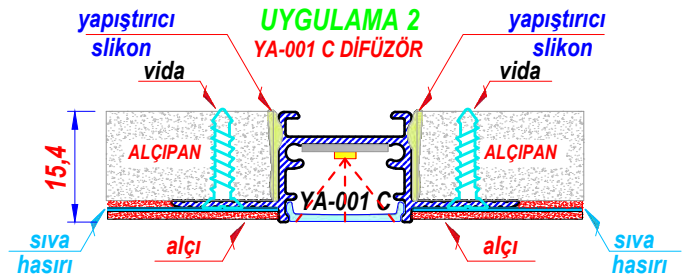
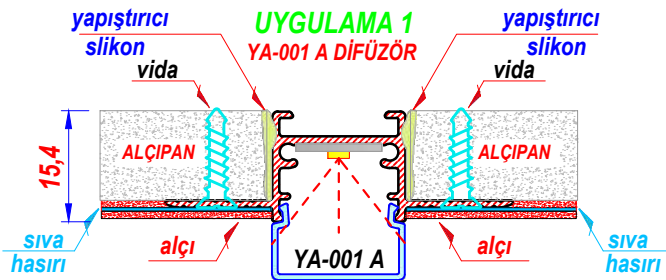

İstenilen ölçülerde kesim yapılır - İstenilen renge boyanır
All cutting dimensions and surface coatings can be done according to requirements

YENİ, KIVRILABİLEN SIVA ALTI LEDLİ ALÇIPAN PROFİL VE AKSESUARLARI
TRIMLESS KASA

YENİ

YA-ALC 02

Alm. Alçıpan Led Kasa

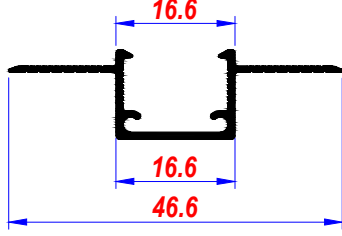

HER YÖNE ESNEYEBİLEN ALM.PRF.

YA-ALC 02

AVZ-001 PS



PC. DİFÜZÖR 25 mt. - ALM.PRF. 610 cm

Alüminyum profil, özel üretim tekniğiyle bükülebilir hale getirilmiştir

AVZ-001 P

PC Cam-Difüzör

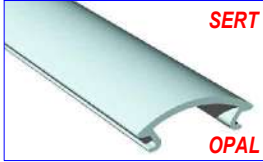
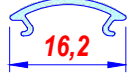

SERT

OPAL

PC.DİFÜZÖR 610 cm
Düz uygulamalar için

AVZ-001 S

Silikon Cam-Difüzör

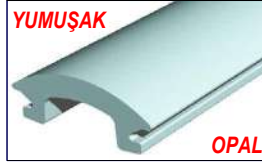

YUMUŞAK

OPAL

25 - 50 mt. RULO

AVZ-001 PS

Modifiye Silikon

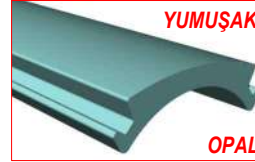

YUMUŞAK

OPAL

25 - 50 mt. RULO

ALC 01 T

Alm. Ken.Tapa

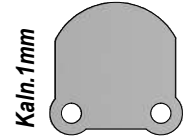

Kalın.1mm



YA-ALS 01 YENİ

Alm.Ledli
Süpürgelik Kasası

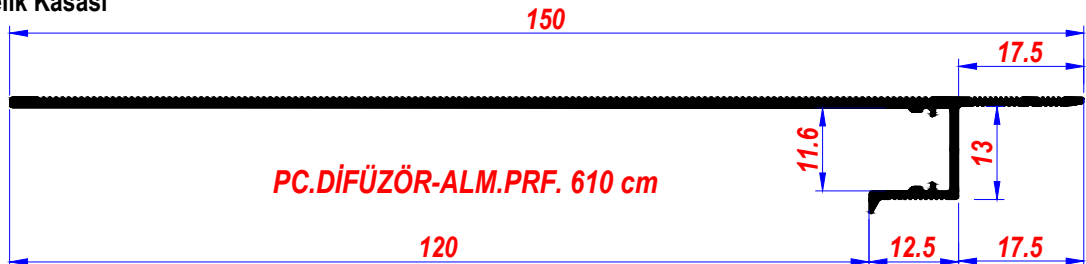

İstenilen ölçülerde kesim yapılır - İstenilen renge boyanır
All cutting dimensions and surface coatings can be done according to requirements

YENİ, SIVA ALTI LEDLİ ALÇIPAN PROFİL VE AKSESUARLARI

YENİ

YA-ALC 03

Alm. Alçıpan Led Kasa

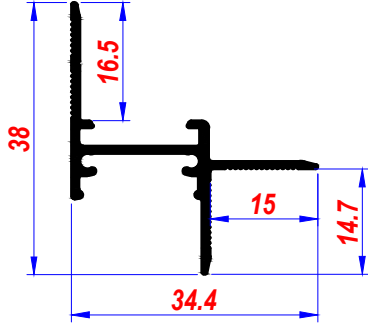

YENİ

YA-ALC 04

Alm. Alçıpan Led Kasa

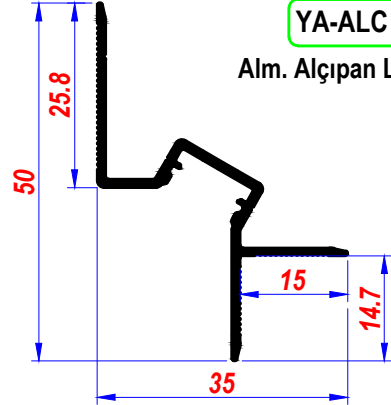

PC.DİFÜZÖR-ALM.PROF. 610 cm

YA-001 C
Düz P.C.Difüzör

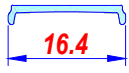

Opal-Şeffaf

Alm.Prf. PC.Difüzör 610 cm

YA-001 E
Düş.Bom.P.C.Difüzör

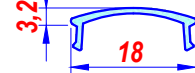

Opal-Şeffaf

YA-019 C

PC. Difüzör



Opal-Şeffaf ÇİZGİLİ
Füme PC, çok yakında

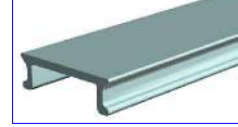
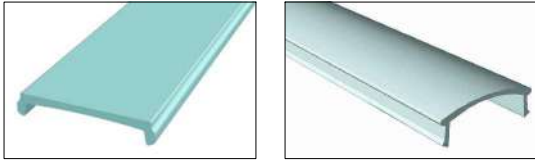

İKİ FARKLI DİFÜZÖR KULLANILABİLİR

UYGULAMA

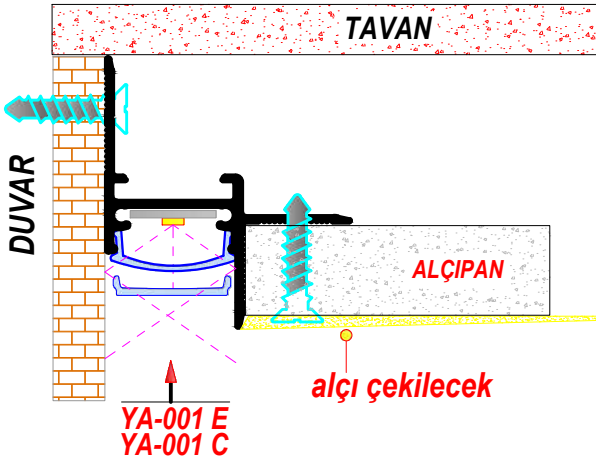

UYGULAMA

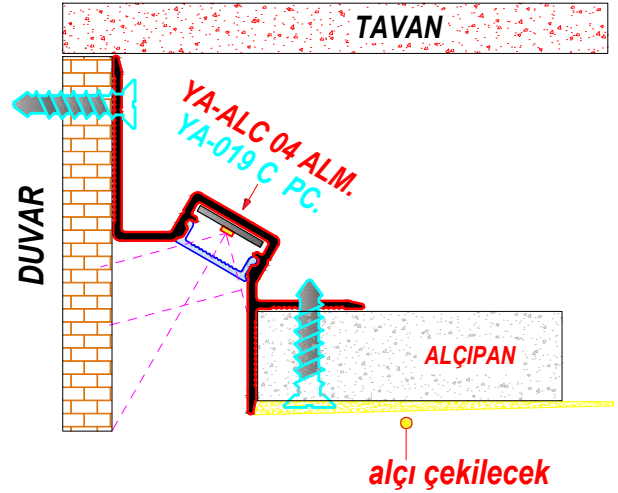

YA-ALC 03 ALM.PROF. ve AKSESUARLARI

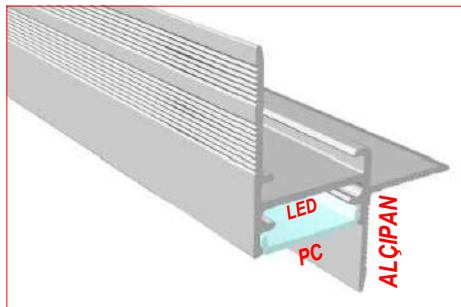

Alm.Prf. PC.Difüzör 610 cm

YA-ALC 04 ALM.PROF. ve AKSESUARLARI

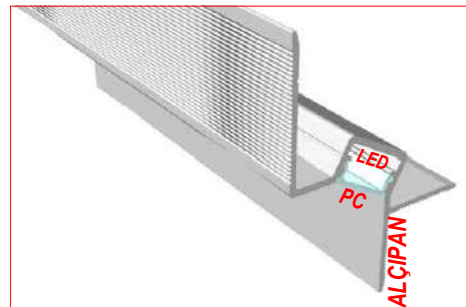

Alm.Prf. PC.Difüzör 610 cm

YA-ALC 03

İstenilen ölçülerde kesim yapılır - İstenilen renge boyanır

YA-ALC 04

All cutting dimensions and surface coatings can be done according to requirements

YENİ, SIVA ALTI - ALÇIPAN PROFİL (35 mm lik)
TRIMLESS KASA

YENİ

ALC-35 S

Alm. Alçıpan Led Kasa

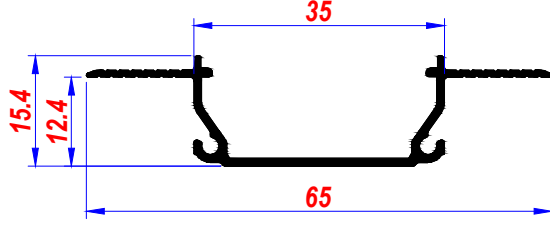

TEK KİŞİYLE UYGULAMASI YAPILAN,
İŞÇİLİĞİ KOLAY ÜRÜN

Kolay montaj için, delikli Alm.profil

Alm. PC. Profil 610 cm

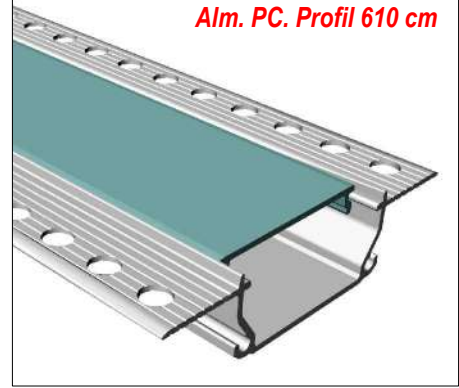

Alçıpana özel, kesintisiz monte edilerek uygulanabilen, dekoratif sıva altı, Ankastr yeni ürün.

YA-G 35 C

PC.Cam-Difüzör

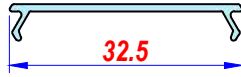

Kumlu Opal
P.C. DİFÜZÖR 610 cm

ALC 35 S-T

Alm. Ken.Tapa



Lazer - 1 mm

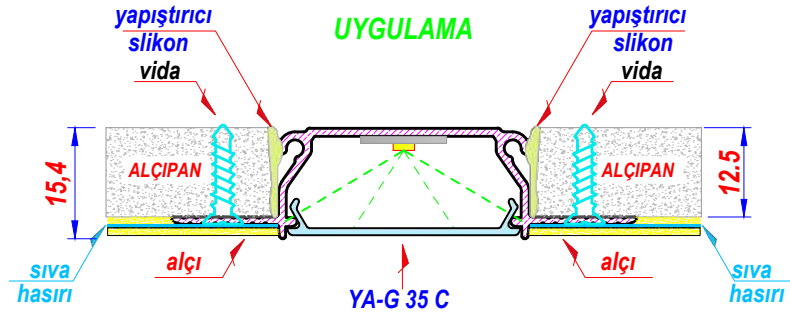

ALC-35 S, ALÇIPAN DUVAR ve TAVAN UYGULAMASI

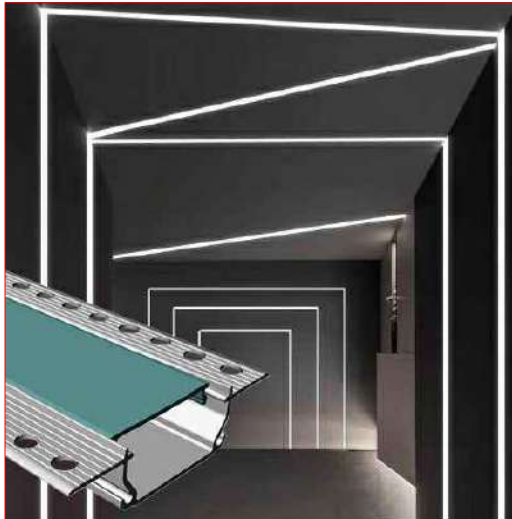

İstenilen ölçülerde kesim yapılır - İstenilen renge boyanır
All cutting dimensions and surface coatings can be done according to requirements

YENİ, SIVA ALTI - ALÇIPAN KASA (50 mm lik)
TRIMLESS KASA

YENİ

ALC-50 S

Alm. Alçıpan Led Kasa

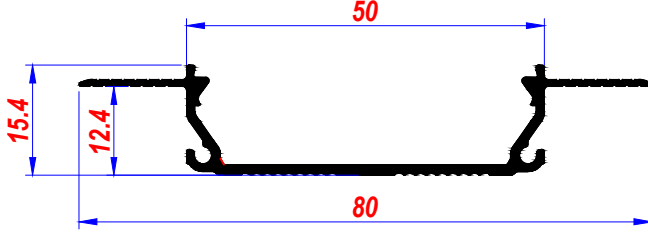

**TEK KİŞİYLE UYGULAMASI YAPILAN,
İŞÇİLİĞİ KOLAY ÜRÜN**

Kolay montaj için, delikli Alm.profil

Alm. PC. Profil 610 cm

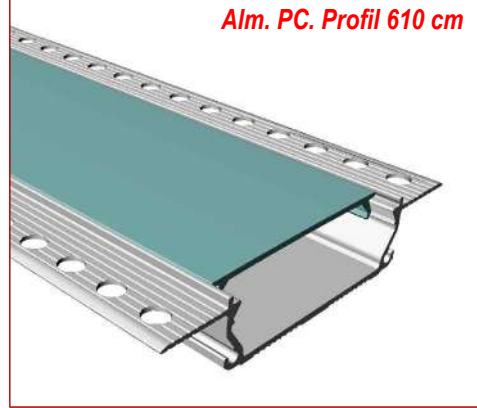

**Alçıpana özel, kesintisiz monte edilerek
uygulanabilen, dekoratif sıva altı,
Ankastre yeni ürün.**

YA-G 50 A

PC.Cam-Difüzör

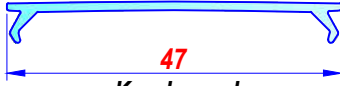

Kumlu opal

ALC 50 S-T

Alm. Ken.Tapa



Lazer - 1 mm

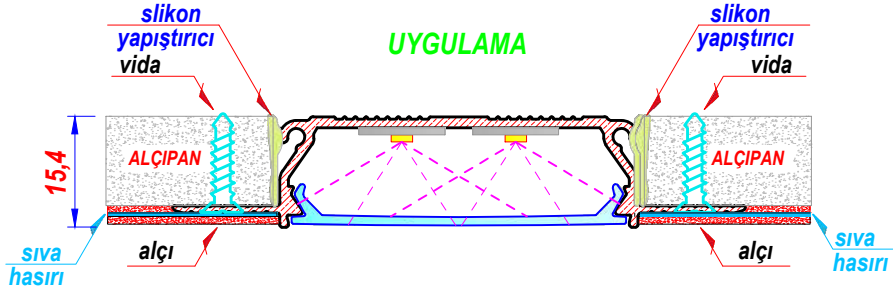

ALC-50 S, ALÇIPAN DUVAR ve TAVAN UYGULAMASI

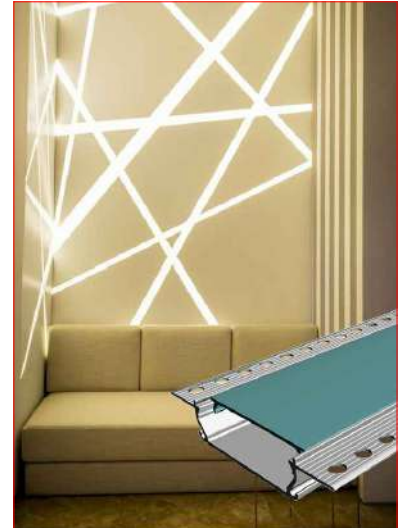

İstenilen ölçülerde kesim yapılır - İstenilen renge boyanır
All cutting dimensions and surface coatings can be done according to requirements

SIVA ALTI - ANKASTRE KASA (35 mm lik)
TRIMLESS KASA

YA-ALC 35

Alm. Alçıpan Led Kasa

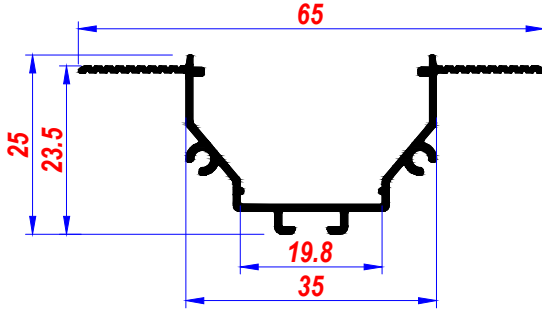

Alçıpan için özel üretilmiştir

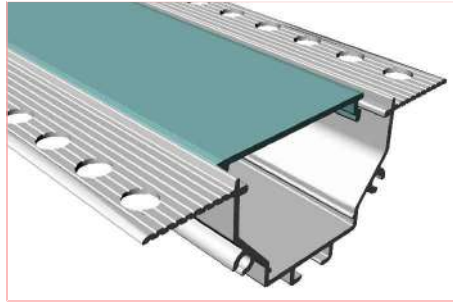

ALM.-PC.PRF. 610 cm

YA-G 35 C

PC.Cam-Difüzör

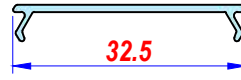

Kumlu Opal
P.C. DİFÜZÖR 610 cm

YA-G 35 Y

Tekli Montaj Yayı



Tek vidalı

YA-ALC 35 T

Alm. Kenar Tapa

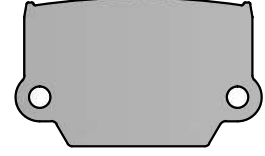

YA-G 35 Y UYGULAMASI



Kasaya, karşılıklı 1'er ad. YA-G35 Y montaj yayı takılarak uygulanır

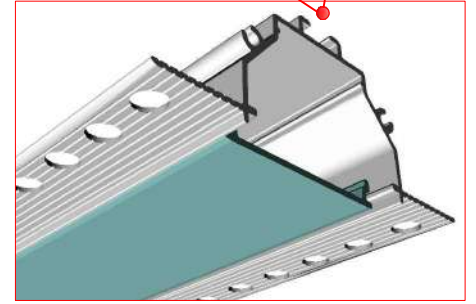

Alçıpana, kesintisiz monte edilerek uygulanabilen, dekoratif siva altı Ankastré yeni küçük ürün

UYGULAMA 1

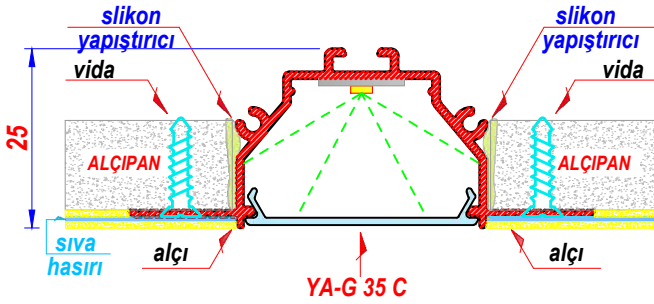

UYGULAMA 2

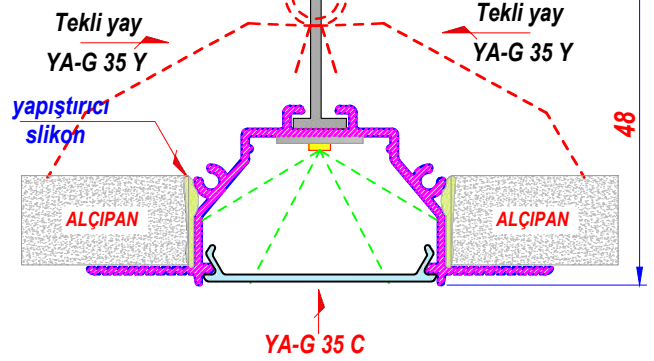

YA-ALC 35 SIVA ALTI KASA UYGULAMASI



İstenilen ölçülerde kesim yapılır - İstenilen renge boyanır
All cutting dimensions and surface coatings can be done according to requirements

SIVA ALTI - GÖMME, ANKASTRE KASALAR (18,6 mm lik)

YENİ

YA-G 19

Alm. Gömme Prf.

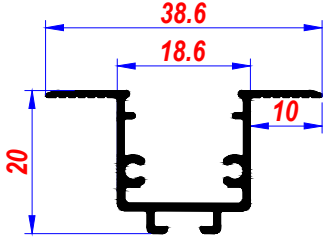

16 mm lik PSV ye uygun
yeni ekonomik GÖMME ÜRÜN

UYGULAMA

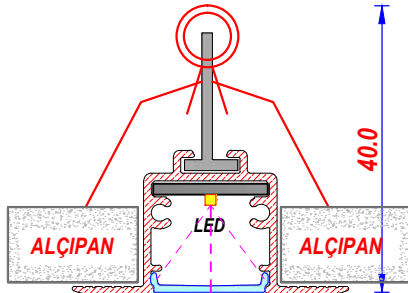

YA 001 A, YA 001 C, YA 001 E, YA 001 F
4 farklı difüzöre uygun, yeni gömme led kasa

YA-001 A

U P.C.Difüzör

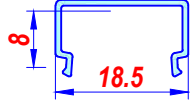

G 19 T A

Alm. Ken.Tapa



YA-001 C

Düz P.C.Difüzör

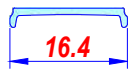

G 19 T C

Alm. Ken.Tapa



4 FARKLI DİFÜZÖR

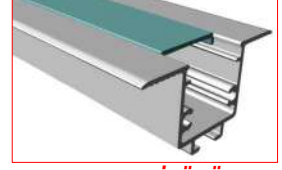

ALM. PRF. - PC. DİFÜZÖR 610 cm

YA-G 35 Y

Tekli Montaj Yayı



M 3 vidalı

YA-001 E

Düş.Bom.P.C.Difüzör

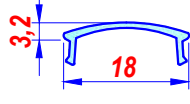

G 19 T E

Alm. Ken.Tapa

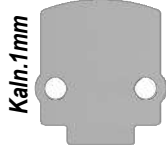

YA-001 F

Orta Bom.P.C.Difüzör

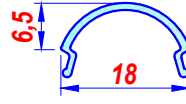

G 19 T F

Alm. Ken.Tapa

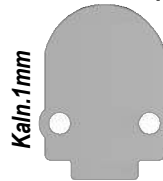

Kasaya, karşılıklı 1 er ad. YA-G35 Y
montaj yayı takılarak uygulanır

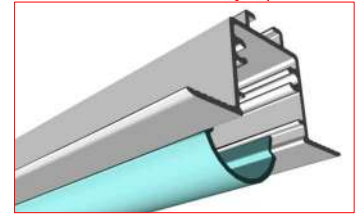

ALM.PR.F. - PC. DİFÜZÖR 610 cm

SIVA ALTI - GÖMME, ANKASTRE KASALAR (35 mm lik)

YA-G 35

Alm.Siva Altı Led Kasa

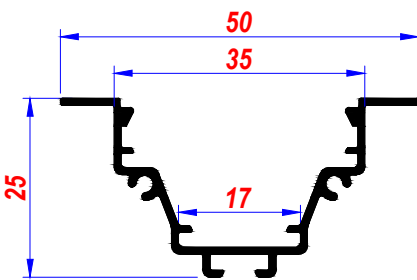

YA-G 35 ALM. - YA-G 35 C PC.

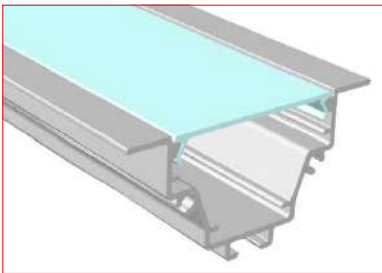

ALM. PR.F.-PC. DİFÜZÖR 610 cm

YENİ

YA-G 35 C

PC.Cam-Difüzör



Kumlu Opal

YA-G 35 T

Alm. L Ken.Tapa

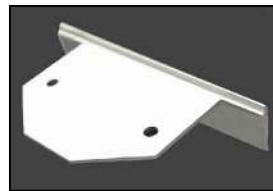

YA-G 35 Y

Tekli Montaj Yayı



M 3 vidalı

UYGULAMA

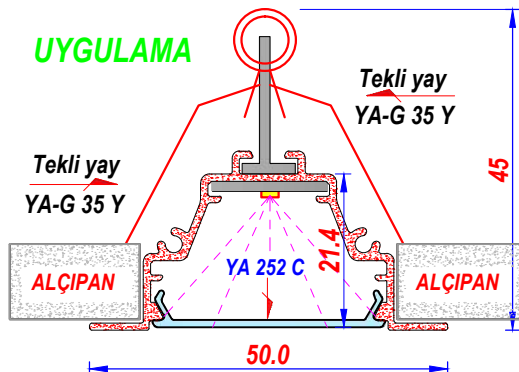

Tekli montaj yayı, uygulamada
ters yönde, 2 ad. takılarak uygulanır



Kasaya, karşılıklı 1 er ad. YA-G35 Y
montaj yayı takılarak uygulanır

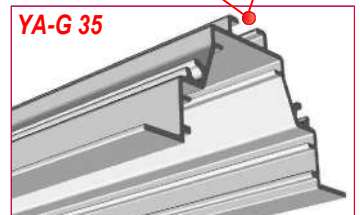

ALM.PR.F. - PC. DİFÜZÖR 610 cm

İstenilen ölçülerde kesim yapılır - İstenilen renge boyanır

All cutting dimensions and surface coatings can be done according to requirements

SIVA ALTI - GÖMME, ANKASTRE KASALAR (40 mm lik)

YENİ

YA-212

Alm. Led Kasa (Küçük)
SIVA ALTI

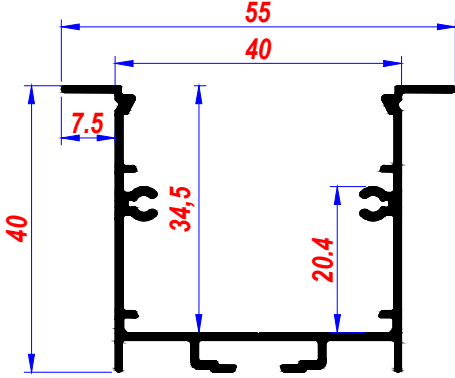

ALM. PRF. 610 cm
Kolay montaj için, iki farklı aparat

YA-1209 C

Alm. Kızak Prf.



YA-212 A

Alçıpan Montaj Aparatı-Metal



1,5 mm Galvaniz

YENİ

YA-213 C

P.C. Difüzör



P.C. DİFÜZÖRLER 610 cm

YENİ

YA-213 U

P.C. U Difüzör

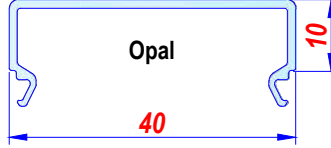

YA-212 ALM. - YA-1209 A PC

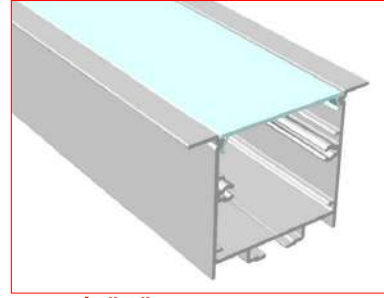

PC.DİFÜZÖR-ALM.PRF. 610 cm

YA-212 B

Alm. Kenar Tapa



İKİ FARKLI KOLAY MONTAJ ŞEKLİ OLAN,
KESİNTİSİZ OLARAK UYGULANABİLEN,
DEKORATİF YENİ ÜRÜN

YA-G 50 C

Alçıpan İkili montaj yayı

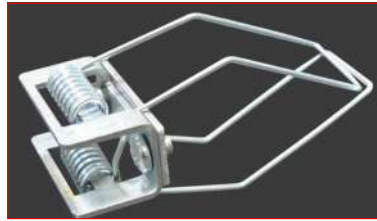

UYGULAMA 1 MONTAJ

İki farklı montaj şekli olan, (Aşağıdaki uygulama 1-2 gibi)

Alçıpan - duvar ve ahşaba, ankastre olarak uygulanır

Kolay montaj, alçıpanı parçalamadan
çıkartılmaya uygun, 2 farklı sistem

Tek kişi ile montaj kolaylığı

UYGULAMA 1

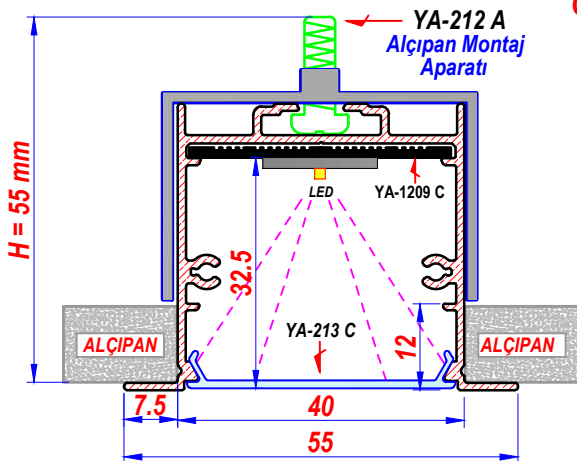

ÖLÇEK 1/1

UYGULAMA 2

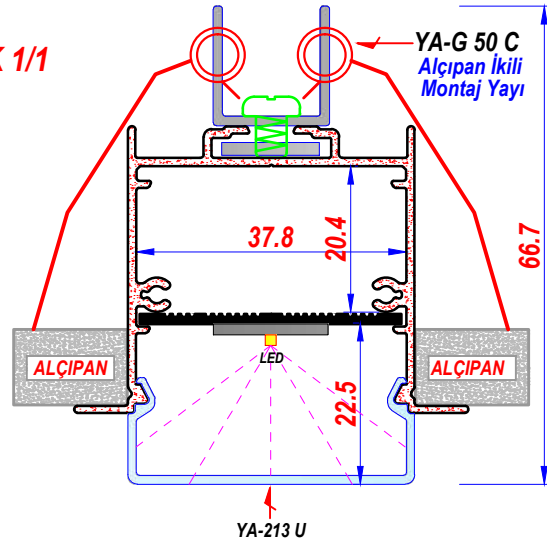

İstenilen ölçülerde kesim yapılır - İstenilen renge boyanır

All cutting dimensions and surface coatings can be done according to requirements

SIVA ALTI - GÖMME, ANKASTRE KASALAR (50 mm lik)

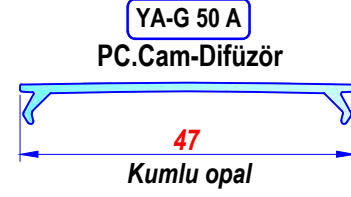
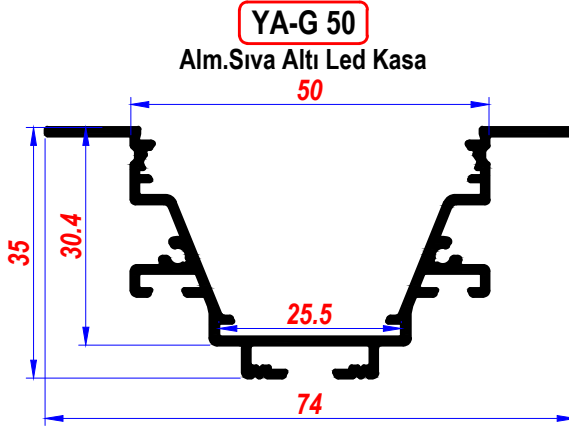

PC.Cam-Difüzör, üstten tatlı sıkı,
takılıp çıkartılabilir

3 Farklı montaj şekli olan, yeni nesil
ekonomik ve dekoratif gömme ürün

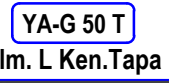
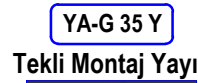
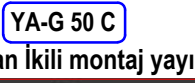

UYGULAMA 1



2 FARKLI TAVAN MONTAJ YAYI

UYGULAMA 2



1,5 mm Galvaniz

UYGULAMA 3

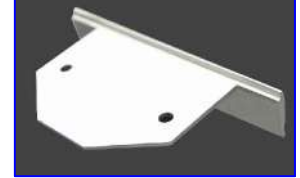

Kalınlık 1,2 mm

UYGULAMA 1

ikili yay seti
YA-G 50 C

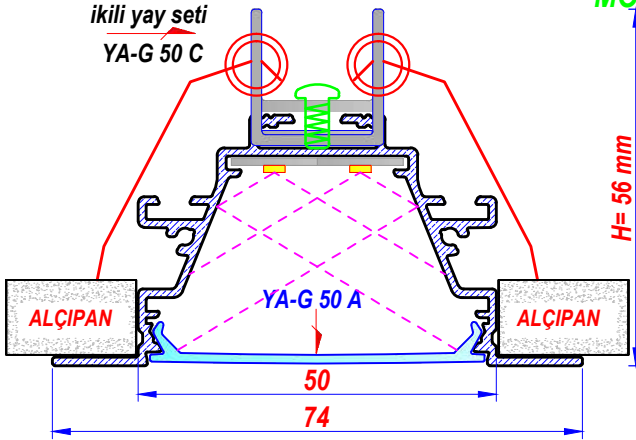

MONTAJ

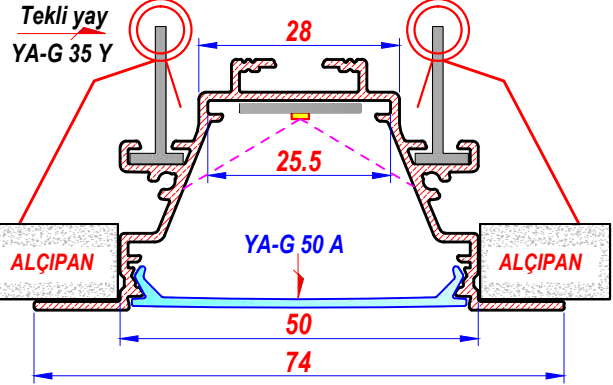

UYGULAMA 2

2 FARKLI YAY VE APARAT İLE MONTAJ ŞEKLİ

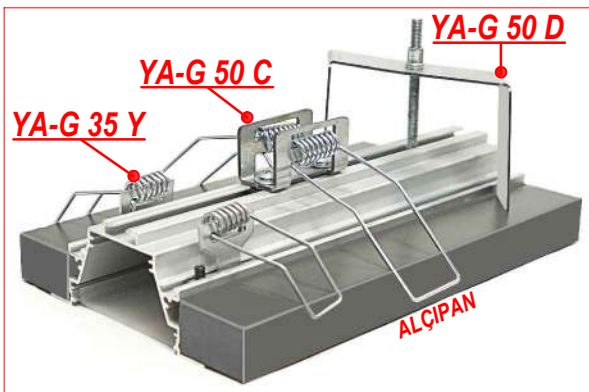

YA G 75 D Aparat ile de, alçıpana montaj yapılabilir

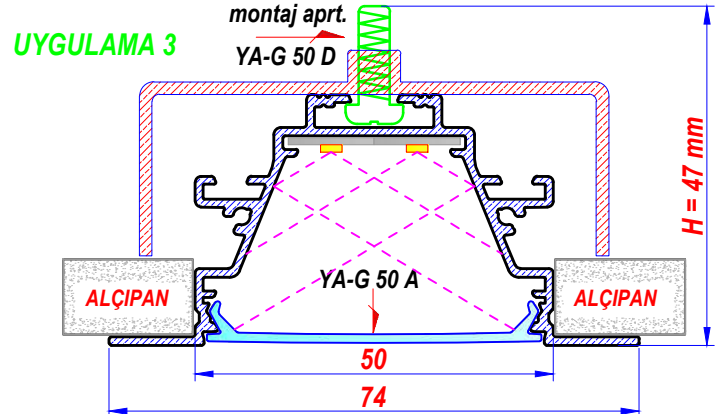

İstenilen ölçülerde kesim yapılır - İstenilen renge boyanır
All cutting dimensions and surface coatings can be done according to requirements

SIVA ALTI - GÖMME, ANKASTRE KASALAR (60 mm lik)

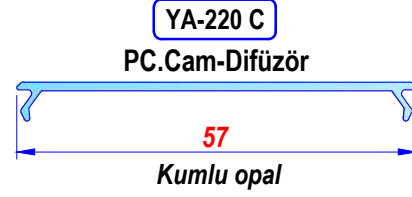
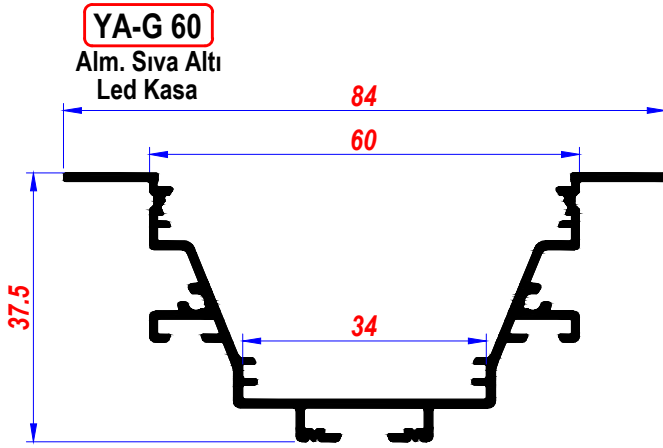

PC.Cam-Difüzör, üstten tatlı sıkı,
takılıp çıkartılabilir

3 Farklı montaj şekli olan, yeni nesil
ekonomik ve dekoratif gömme ürün



2 FARKLI TAVAN MONTAJ YAYI

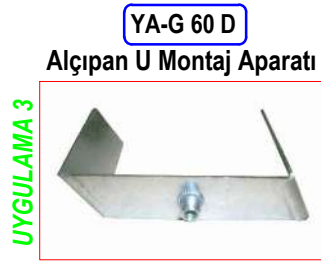

1,5 mm Galvaniz



Kalınlık 1,2 mm

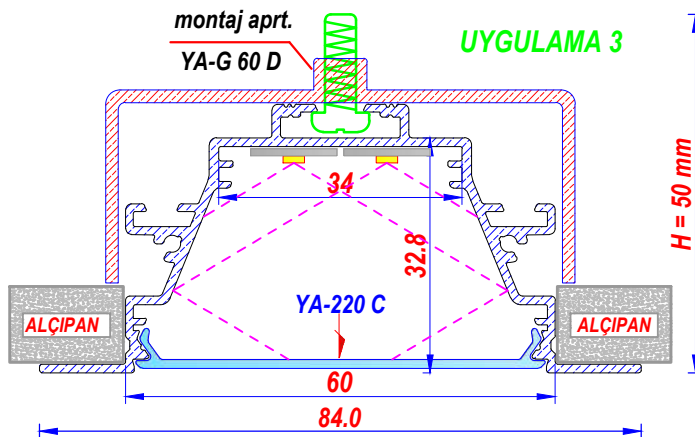
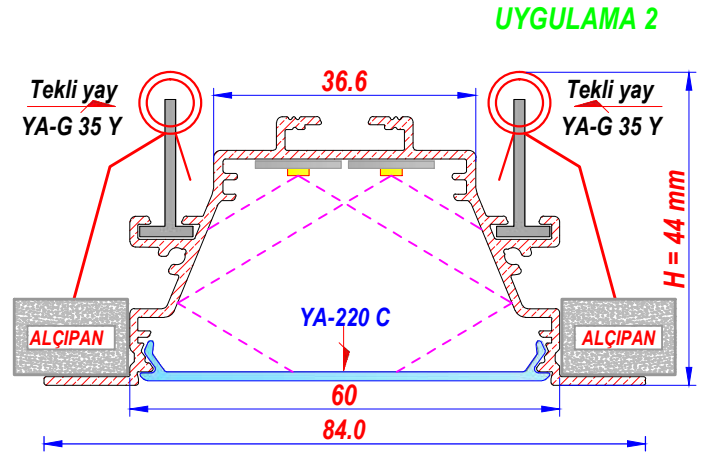
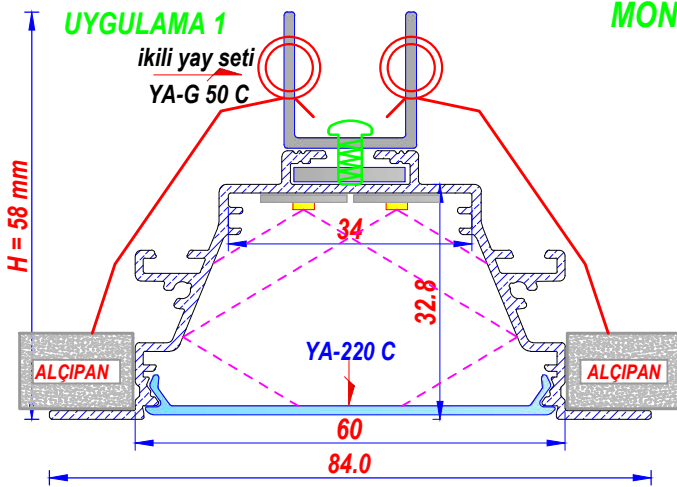

2 FARKLI YAY VE APARAT İLE MONTAJ ŞEKLİ

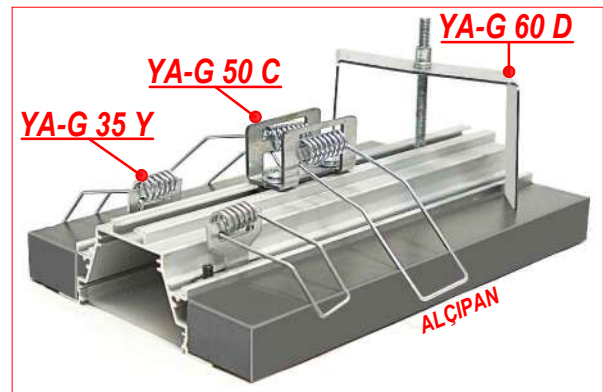

İstenilen ölçülerde kesim yapılır - İstenilen renge boyanır
All cutting dimensions and surface coatings can be done according to requirements

SIVA ALTI - GÖMME, ANKASTRE KASALAR (64,4 mm lik)

YA-210

Alm. Led Kasa (Orta)
SIVA ALTI

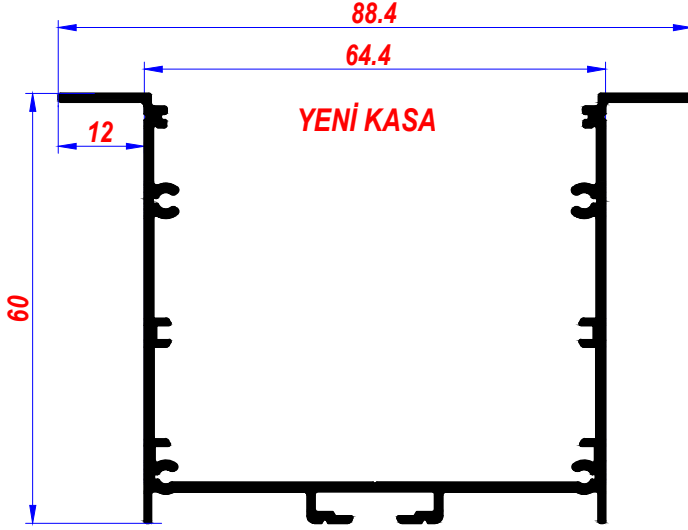

YA-210

Alm. Led Kasa (Orta)
SIVA ALTI

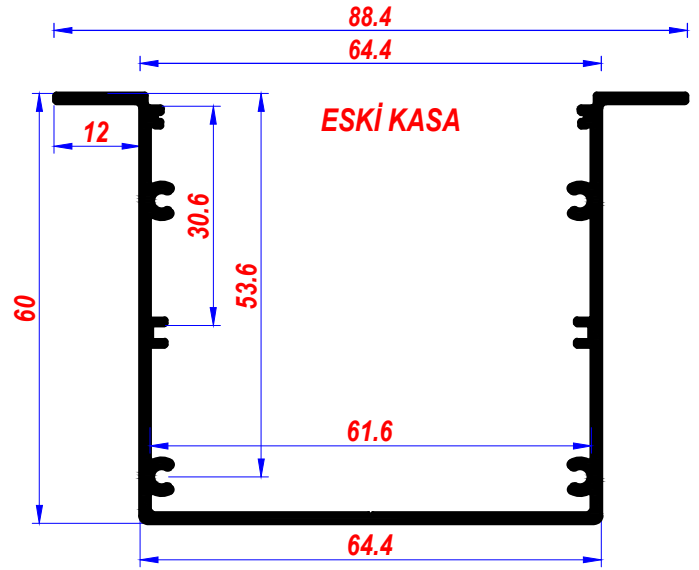

ALÇI TAVAN ve DUVARA GÖMME OLARAK
KESİNTİSİZ UYGULANABİLEN,
DEKORATİF SIVA ALTI, YENİ ÜRÜN
Tek kişi ile montaj kolaylığı

Kolay montaj, alçıpanı parçalamadan
çıkartılmaya uygun, 2 farklı sistem

YA-210 A

Alçıpan U Montaj Aparatı-Metal

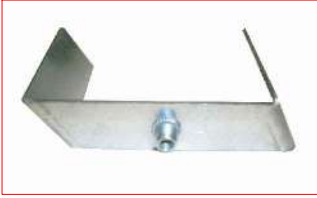

YA-G 50 C

Alçıpan İkilili montaj yayı

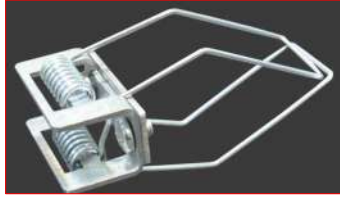

YA-210 B

Alm.Kenar Tapa



YA-1210 A

P.C. Difüzör

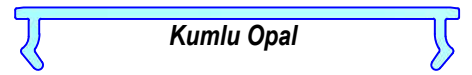

YA-1210 C

Alm. Kızak Prf.



İki farklı montaj şekli olan, (uygulama 1-2 gibi)
Alçıpan - duvar ve ahşaba, ankastre olarak uygulanır

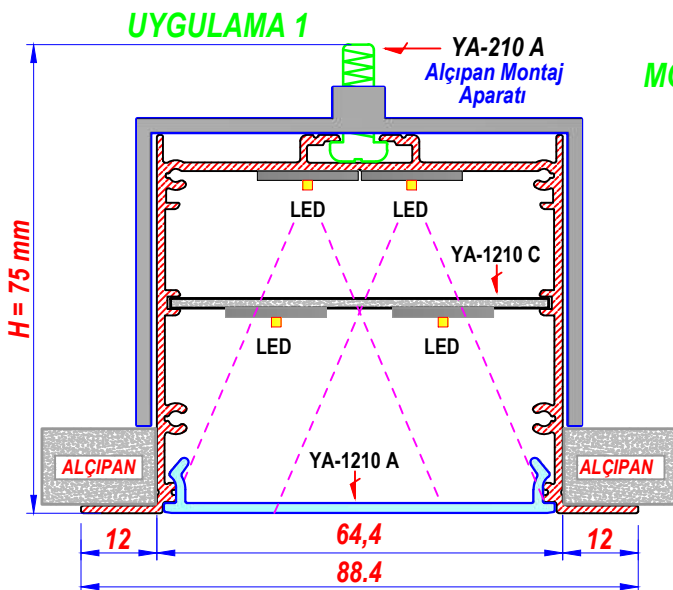

MONTAJ

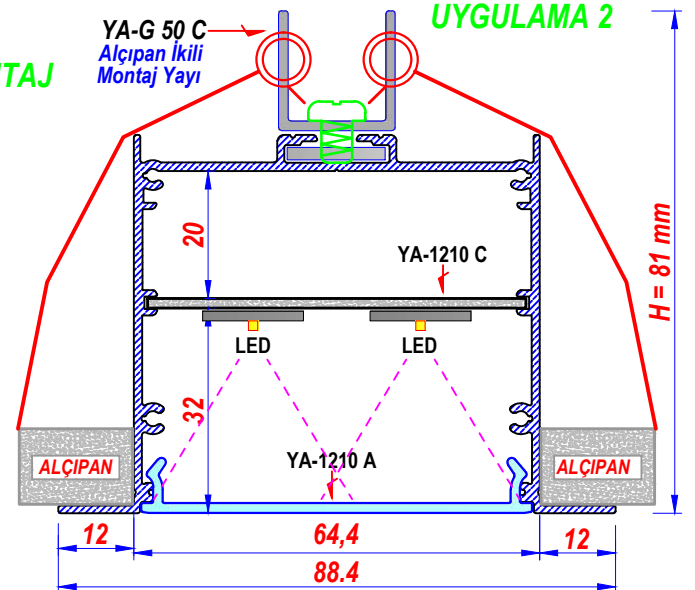

İstenilen ölçülerde kesim yapılır - İstenilen renge boyanır
All cutting dimensions and surface coatings can be done according to requirements

YENİ SLİM, SIVA ALTI EKONOMİK GÖMME KASA (13,6 x 75 mm lik)

YENİ

YA-G75 EKO

Alm.Sıva Altı Led Kasa

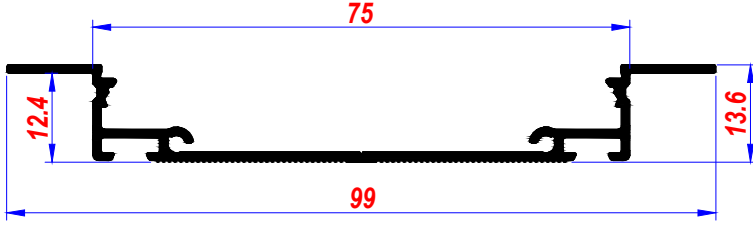

ALM. PRF. ve PC. DİFÜZÖR 610 cm.



MİNİMUM YÜKSEKLİK, MAKSİMUM VERİM

YÜKSEKLİĞİ AZ, GENİŞLİĞİ FAZLA, YENİ ANKASTRE ÜRÜN

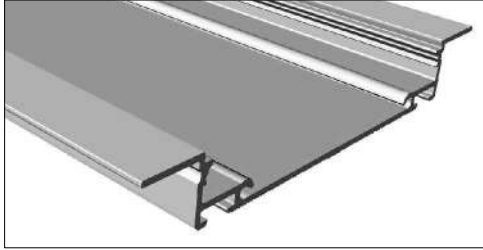

YA-G75 EKO Alm.Prf. 610 cm

YA-222 C

PC.Cam-Difüzör

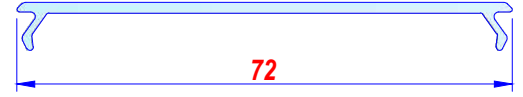

Kumlu opal

YA-G 35 Y

Tekli Montaj Yayı



m 3 Setskur Vidalı

YA-G 75 EKO T

Alm. L Ken.Tapa

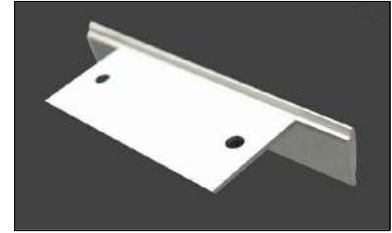

Kalınlık 1,2 mm

TAVAN UYGULAMASI



UYGULAMA

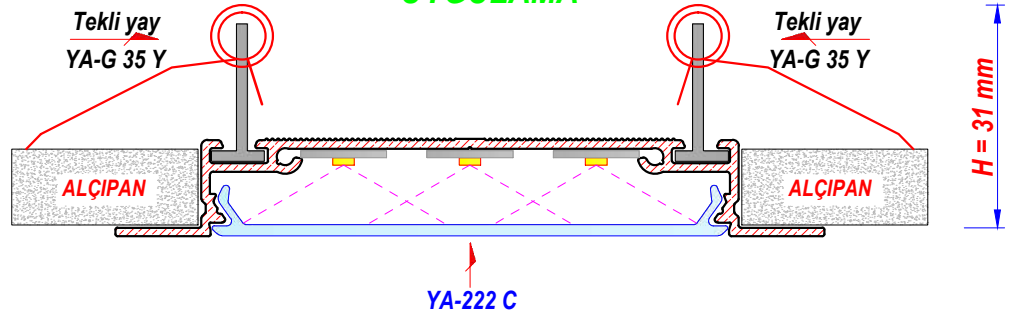

**TAVAN ve DUVARA GÖMME OLARAK
KESİNTİSİZ UYGULANABİLEN,
DEKORATİF SIVA ALTI, YENİ ÜRÜN**
Alçıpan - Duvar ve Ahşaba, ankastre olarak uygulanır

İstenilen ölçülerde kesim yapılır - İstenilen renge boyanır
All cutting dimensions and surface coatings can be done according to requirements

SIVA ALTI - GÖMME, ANKASTRE KASALAR (75 mm lik)

YA-G 75

Alm.Siva Altı Led Kasa

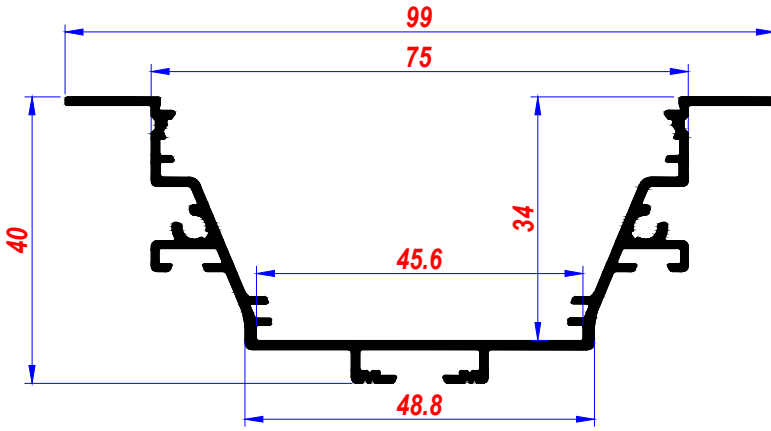

YA-222 C

PC.Cam-Difüzör

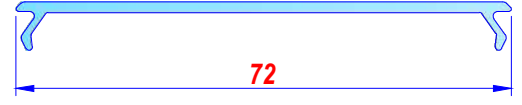

Kumlu opal

YA-G 50 C

Alçıpan İkili montaj yayı

UYGULAMA 1



YA-G 35 Y

Tekli Montaj Yayı

UYGULAMA 2



2 FARKLI TAVAN MONTAJ YAYI

ALÇI TAVAN ve DUVARA GÖMME OLARAK
KESİNTİSİZ UYGULANABİLEN,
DEKORATİF SIVA ALTI, ÜRÜN

3 farklı montaj şekli olan, (uygulama 1,2,3 gibi)
Alçıpan - duvar ve ahşaba, ankastre olarak uygulanır

YA-G 75 T

Alm. L Ken.Tapa

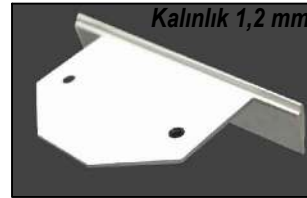

YA-G 75 D

Alçıpan U Montaj Aparatı



UYGULAMA 3

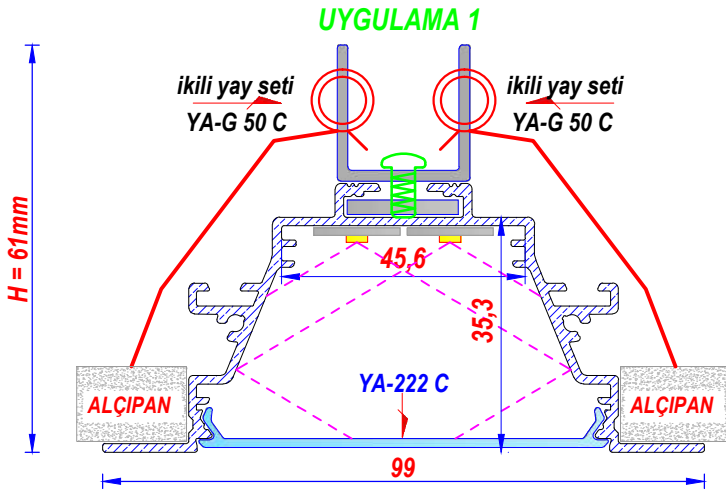

2 ÇEŞİT YAY ve METAL APARAT İLE MONTAJ ŞEKLİ

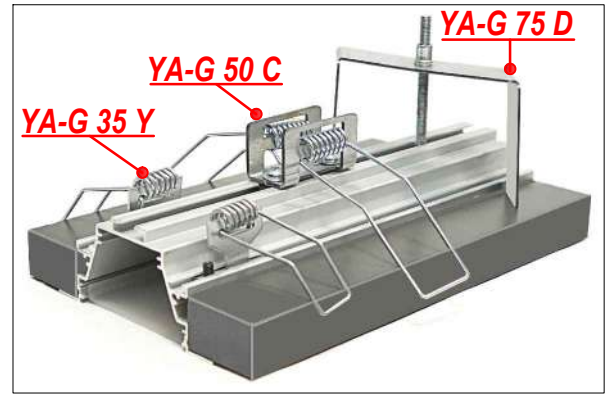

MONTAJ

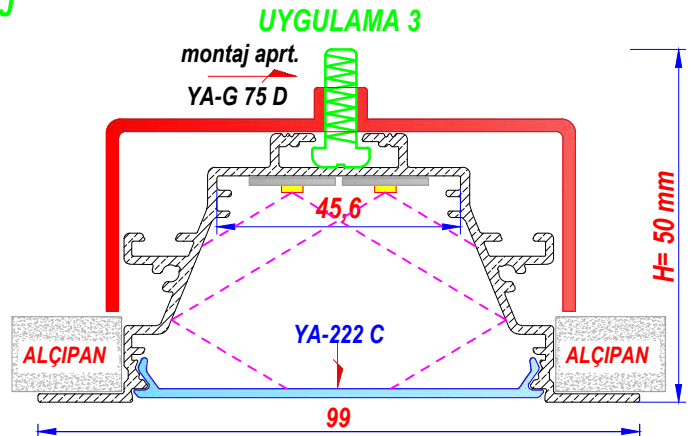
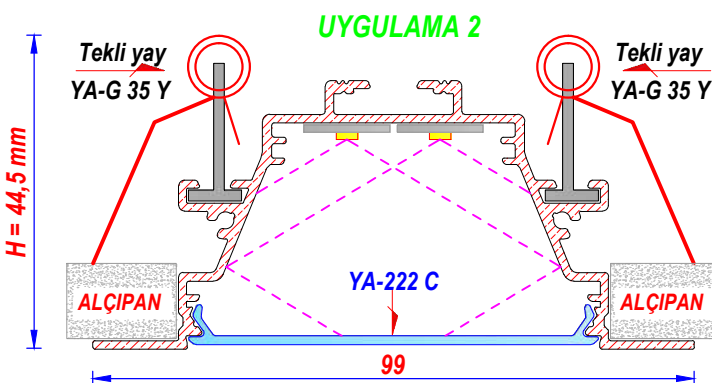

İstenilen ölçülerde kesim yapılır - İstenilen renge boyanır
All cutting dimensions and surface coatings can be done according to requirements

SIVA ALTI - GÖMME, ANKASTRE KASALAR (100 mm lik)
100

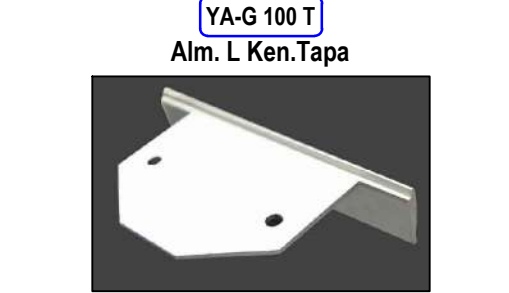
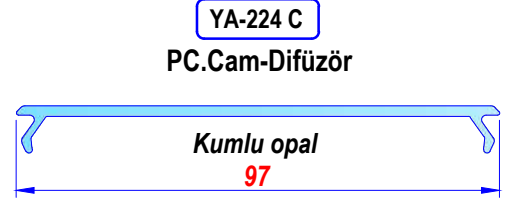
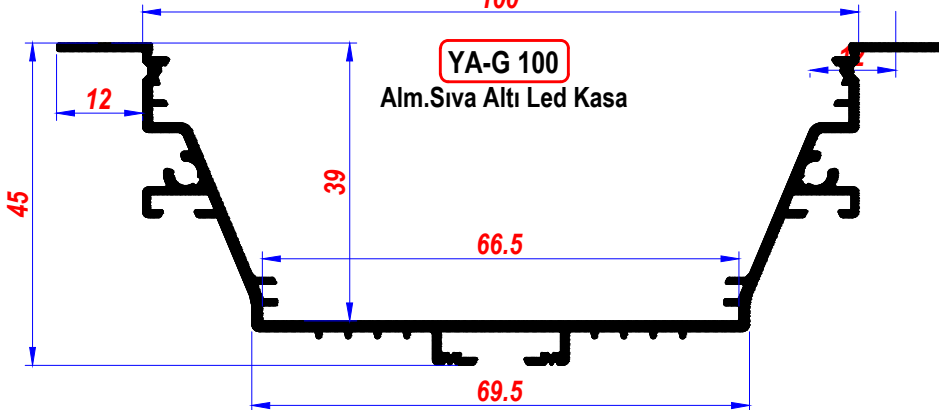

3 farklı montaj şekli olan, (uygulama 1,2,3)
Tavan - Alçıpan - duvar ve ahşaba, ankastre olarak uygulanır
İKİLİ YAY İLE MONTAJ

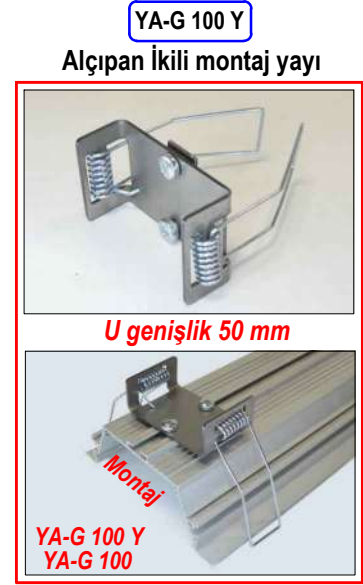
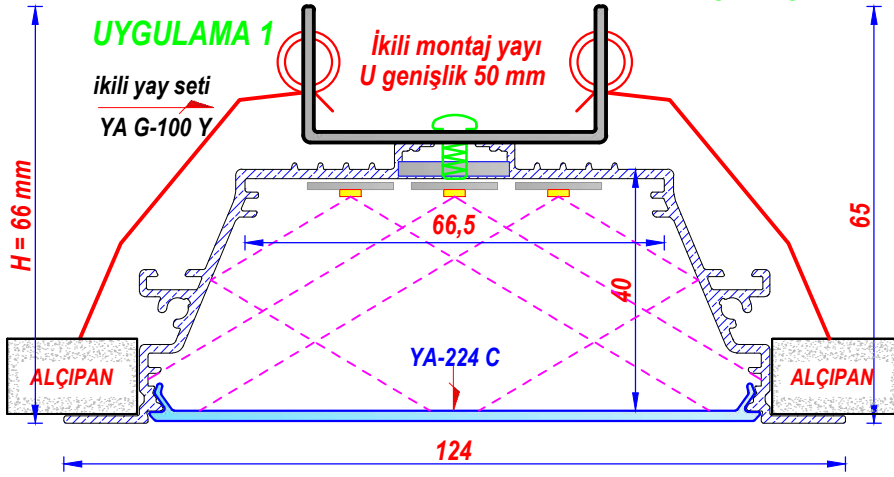

UYGULAMA 1

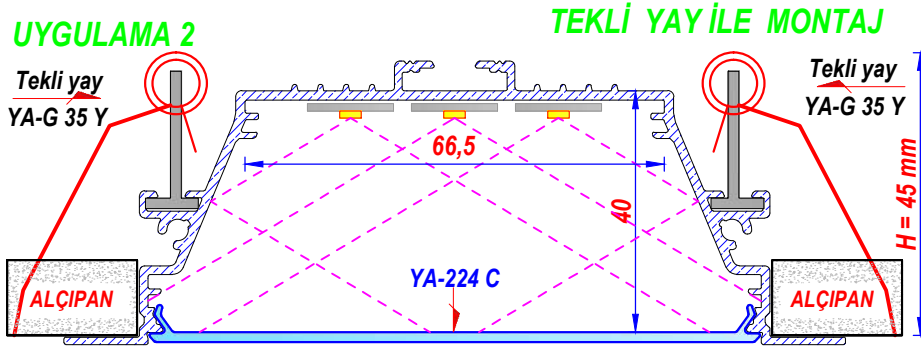

UYGULAMA 2

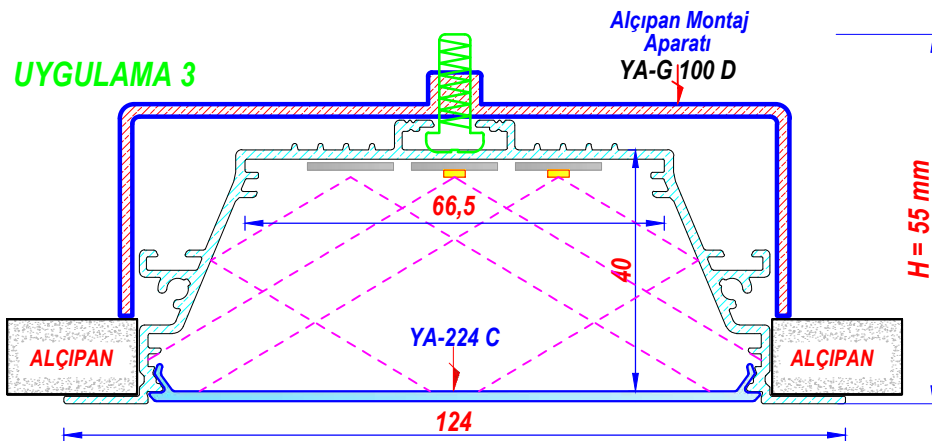

UYGULAMA 3

İstenilen ölçülerde kesim yapılır - İstenilen renge boyanır

YA-253 A

Büyük Ayak Seti
Tek Vidalı

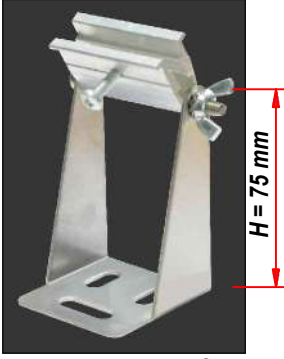

Paslanmaz Ayak Seti
Kalinlık 1,5 mm

YA-253 B

Küçük Ayak Seti
Tek Vidalı

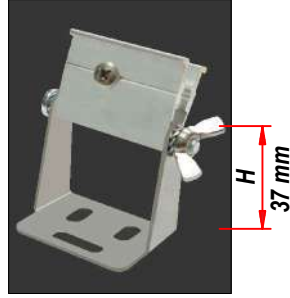

Paslanmaz Ayak Seti
Kalinlık 1,2 mm

YA-253 F

Özel Ayak Seti
Tek Vidalı



Paslanmaz Ayak Seti
Kalinlık 1,5 mm

YA-253 M

Minik Ayak Seti
Tek Vidalı

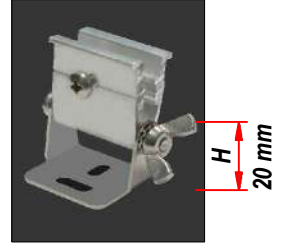

Paslanmaz Ayak Seti
Kalinlık 1 mm

YA-253 C

Lüks Kç. Ayak Seti
İki Vidalı

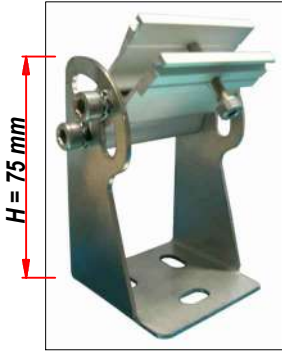

Paslanmaz Ayak Seti
Kalinlık 1,5 mm

YA-253 D

Lüks Orta Ayak Seti
İki Vidalı

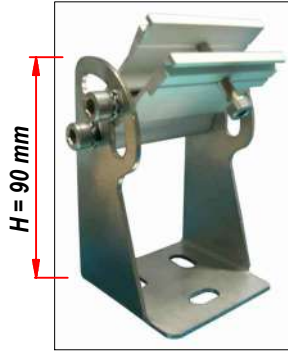

Paslanmaz Ayak Seti
Kalinlık 1,5 mm

YA-253 D 1

Lüks By. Ayak Seti
İki Vidalı

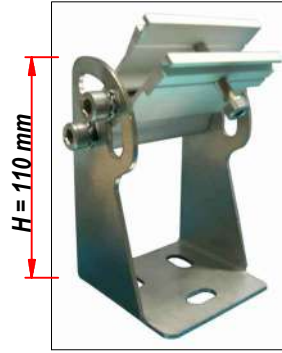

Paslanmaz Ayak Seti
Kalinlık 1,5 mm

YA-253 E

Lüks By. Ayak Seti
İki Vidalı

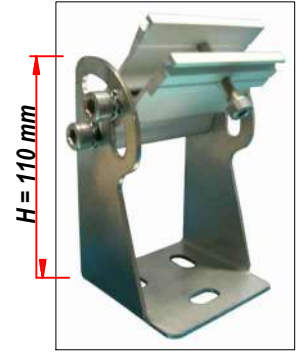

Paslanmaz Ayak Seti
Prj. Kasalarına uygun
Kalinlık 2mm

YA-253 L

L KOL
Uzatma Aparatı

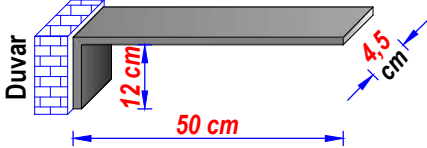

WW - Uzatma Aparatı
Kalinlık 3 mm - Uzunluk 50 cm
A. Gri - Elk. Stk. Toz Boyalı

YA-253 L 1

L KOL
Uzatma Aparatı

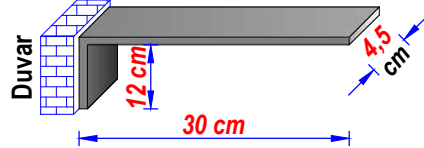

WW - Uzatma Aparatı
Kalinlık 3 mm - Uzunluk 30 cm
A. Gri - Elk. Stk. Toz Boyalı

YA-253 L 2

L KOL
Uzatma Aparatı

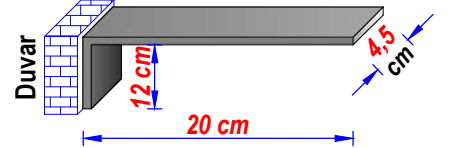

WW - Uzatma Aparatı
Kalinlık 3 mm - Uzunluk 20 cm
A. Gri - Elk. Stk. Toz Boyalı

Renk A.Gri

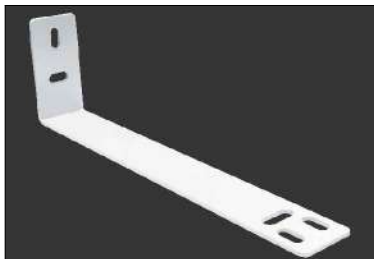

YA 253 L - YA 253 L1 - YA 253 L2

Renk A.Gri

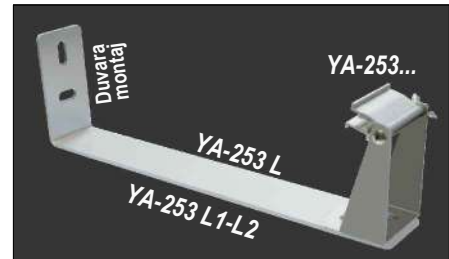

L AYAK ve AYAK SETİNİN MONTAJI

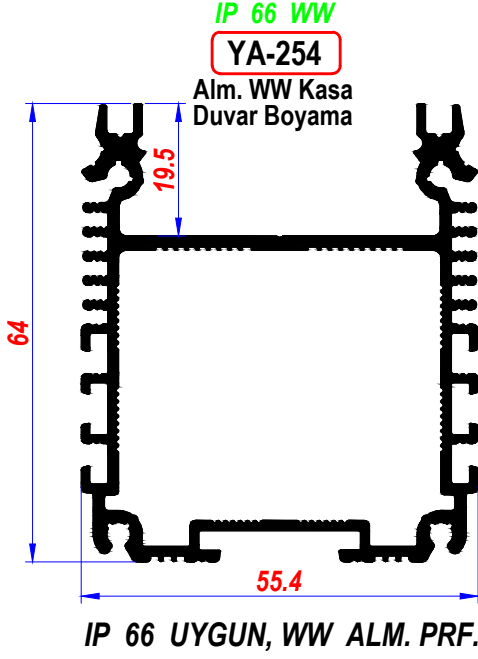

YA-254 YA-254 A YA-254 C



ALM. PRF. - PC. CAM 610 cm

YA-254 ALM. PRF. ve AKSESUARLARI



IP 66 ya uygun yeni wallwasher ürün
Yeni nesil dekoratif UV katkılı Policarbon cam (Coeks)
Sızdırmaz fitil, cam takviyeli kenar tapa

İstenilen ölçülerde kesim yapılır - İstenilen renge boyanır
All cutting dimensions and surface coatings can be done according to requirements

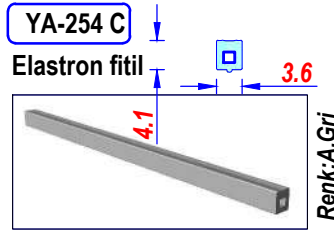
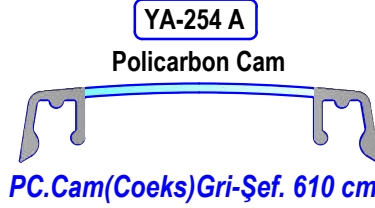

PC. Cam Fitoli

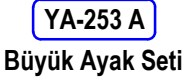

Paslanmaz Ayak Setleri

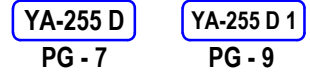
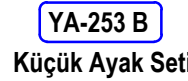

Wallwasher - Projektör
Kasalarına uygun



Güçlendirilmiş Polyamid
M 4 X 12 İMBUS VİDA KULLANILMALIDIR

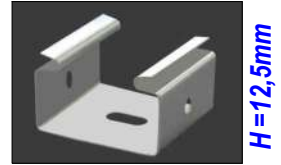
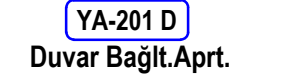

Paslanmaz Klips

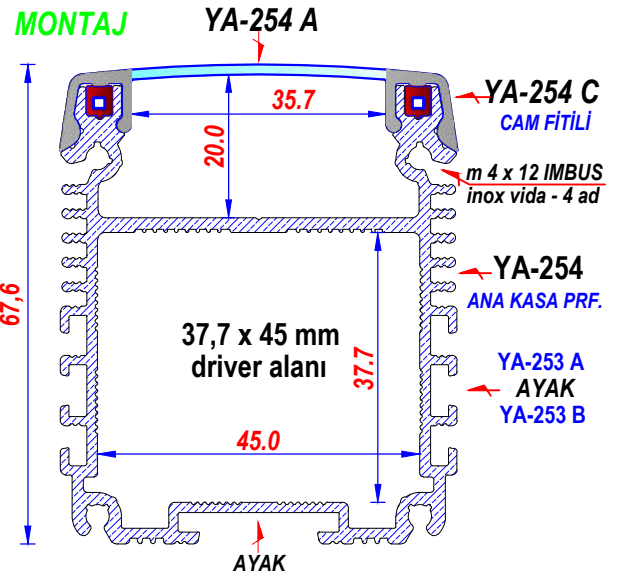

37,7 x 45 mm lik geniş driver alanı
3 noktadan ayak takma yeri (Sağ-sol-alt)
DEKORATİF, CAM TAKVİYELİ PLS. KENAR TAPA

YA-255

Alm. WW Kasa (Küçük)

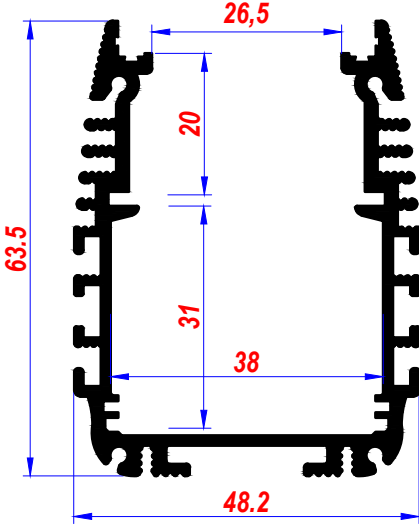

EKONOMİK ÇOK SATAN ÜRÜN

YA-255 A

Alm.İç Kızak Prf.

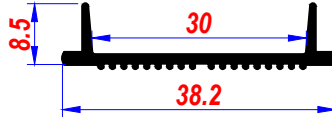

IP 65 e UYGUN ÜRÜN
CAM TAKVİYELİ POLYAMİD
PLASTİK KENAR TAPA
İSTENİLEN ÖLÇÜLERDE TEMPERLİ CAM
3 NOKTADAN AYAK TAKMA YERİ
sağ-sol-alt

YA-255 B

Pls. Ken. Tapa+Conta

Renk:A.Gri



Cam takviyeli polyamid
m 3 x 12 x 4 ad. imbus vida

YA-253 A

Büyük Ayak Seti



H = 76 mm

Paslanmaz Ayak Seti

YA-253 B

Küçük Ayak Seti



H = 37 mm

YA-255 D

PG - 7

Polyamid Rakor-IP 68



Wallwasher - Projektör
Kasalarına uygun

YA-255 D 1

PG - 9

Polyamid Rakor-IP 68

YA-255 E

PG - 7

Metal Rakor-IP 68



Wallwasher - Projektör
Kasalarına uygun

YA-255 E 1

PG - 9

Metal Rakor-IP 68

YA-255 PV

Polyamid

Havalandırma Ventili



Wallwasher - Projektör
Kasalarına uygun

YA-255 MV

Metal

Havalandırma Ventili

- İSTENİLEN ÖLÇÜLERDE TEMPERLİ CAM
- PROFİLE UYGUN AYAK SETİ ; YA-253 A , YA-253 B , YA 253 C
- FARKLI ÖLÇÜLERDE TEK-ÇİFT VİDALI PASLANMAZ AYAK SETİ

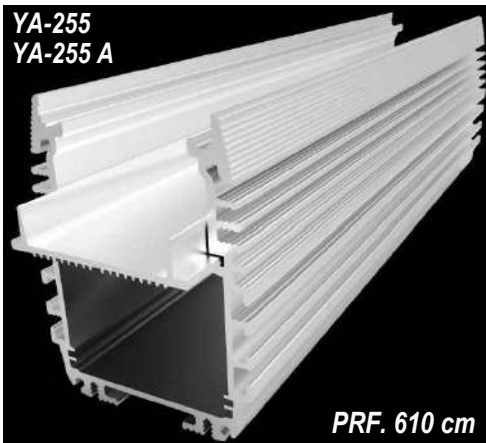

Farklı ölçülerde tek-çift vidalı ayak seti mevcut

MONTAJ YA-255



3 NOKTADAN AYAK TAKILABİLİR
SAĞ - SOL - ALT

İstenilen ölçülerde kesim yapılır - İstenilen renge boyanır
All cutting dimensions and surface coatings can be done according to requirements

YD-003

Alm. WW Kasa (Orta)

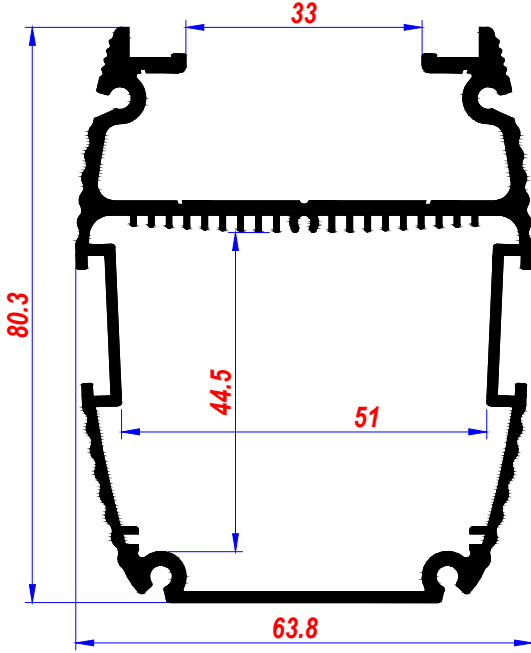

IP 65 e UYGUN ÜRÜN
İSTENİLEN ÖLÇÜLERDE TEMPERLİ CAM

MONTAJ



YA-253 D

2 NOKTADAN (SAĞ -SOL) AYAK TAKILABİLİR

YD-003 A

PLS. Ken.Tapa + Conta
Cam Takviyeli Polyamid

Renk : A.Gri

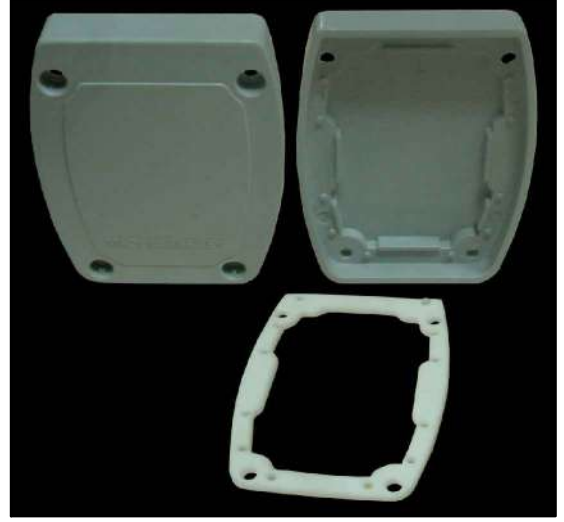

M 4 X 14 IMBUS VİDA KULLANILMALIDIR

- İSTENİLEN ÖLÇÜLERDE TEMPERLİ CAM
- PROFİLE UYGUN AYAK SETİ ; YA-253 D
- FARKLI ÖLÇÜLERDE TEK-ÇİFT VİDALI PASLANMAZ AYAK SETİ

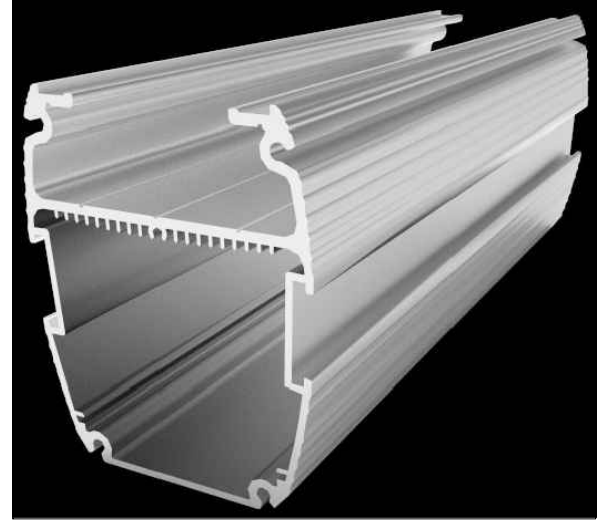

PRF. 610 cm

YD - 003

YA-255 D

PG - 7

YA-255 D 1

PG - 9



Polyamid Rakor - IP 68



Metal Rakor-IP 68

YA-255 E

PG - 7

YA-255 E 1

PG - 9



İstenilen ölçülerde kesim yapılır - İstenilen renge boyanır
All cutting dimensions and surface coatings can be done according to requirements

YD-004

Alm. WW Kasa (Büyük)

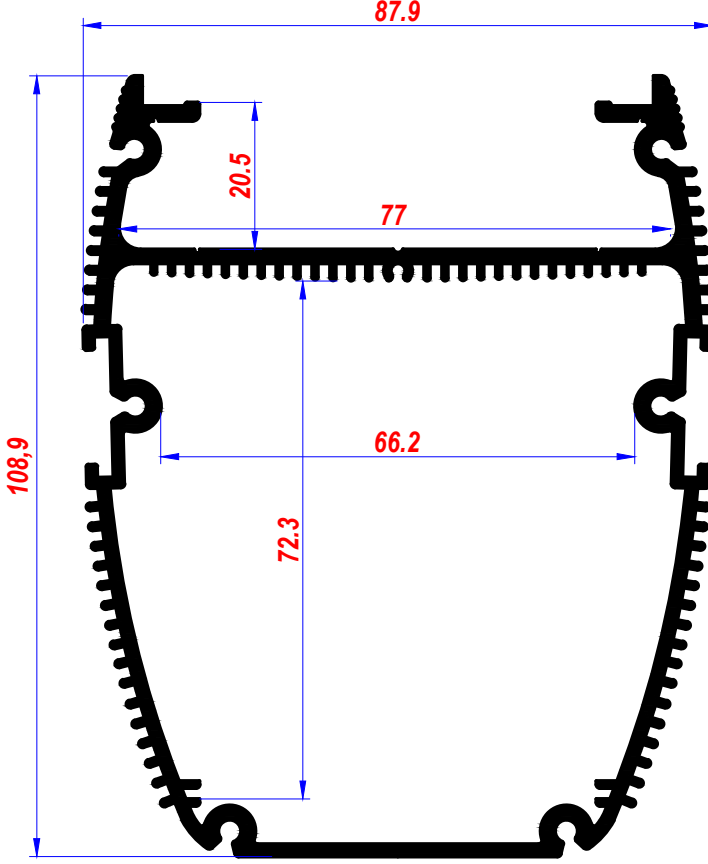

İKİ SIRA LED İÇİN UYGUN KASA

YD-004 A

PLS. Ken.Tapa + Conta
Cam Takviyeli Polyamid

Renk : A.Gri



M 4 X 10 İMBUS VİDA KULLANILMALIDIR

IP 65 e UYGUN ÜRÜN

FİRMA İSMİ İÇİN ETİKET YUVASI

İSTENİLEN ÖLÇÜLERDE TEMPERLİ CAM

DEKORATİF CAM TAKVİYELİ, PLS. KENAR TAPA

MONTAJ YD - 004



2 NOKTADAN (SAĞ - SOL) AYAK TAKILABİLİR



- İSTENİLEN ÖLÇÜLERDE TEMPERLİ CAM
- PROFİLE UYGUN AYAK SETİ ; YA-253 D1
- Farklı ölçülerde tek - çift vidalı ayak seti mevcut

YA-255 D YA-255 D 1
PG - 7 PG - 9
Polyamid Rakor - IP 68

YA-255 E YA-255 E 1
PG - 7 PG - 9
Metal Rakor - IP 68

İstenilen ölçülerde kesim yapılır - İstenilen renge boyanır
All cutting dimensions and surface coatings can be done according to requirements

ALÜMİNYUM EKSTRÜZYON DUVAR BOYAMA WW - SOKAK ARMATÜRÜ
POLİKARBON DİFÜZÖR

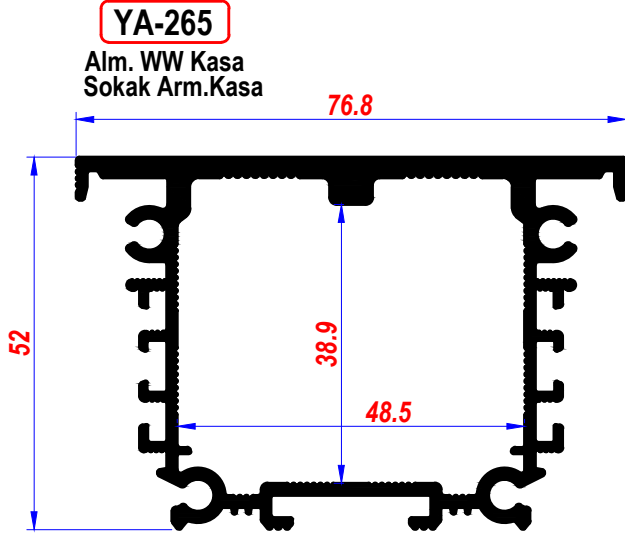

IP 66, SOKAK ARM.-DUVAR BOYAMA KASASI

YA-265 P

Enj. PC.Difüzör+Conta



Gen. 75,5 mm-Uz. 350 mm-H=22,5 mm
PCB ALANI ; 50 mm x 315 mm

YA-265 P1

Enj. PC.Difüzör Çerçevesi



YA-265 W Alm. WW Set



PC DIFFUSER; 35 CM

YA-265 S Sokak Aydınlatma Armatürü



YA-253 A **YA-253 B**

Mini Ayak Seti

H of YA-253 A = 75 mm



H of YA-253 B = 37 mm

Paslanmaz Ayak Seti

Üç noktadan ayak takabilme
Çift sıra led kullanımına uygun
Park, site içi, dekoratif sokak armatürü
Daha geniş driwer alanı

IP 66 KORUMALI, PC ENJ. DİFÜZÖRLÜ, YENİ EKONOMİK
DUVAR BOYAMA ve SOKAK ARMATÜR KASASI

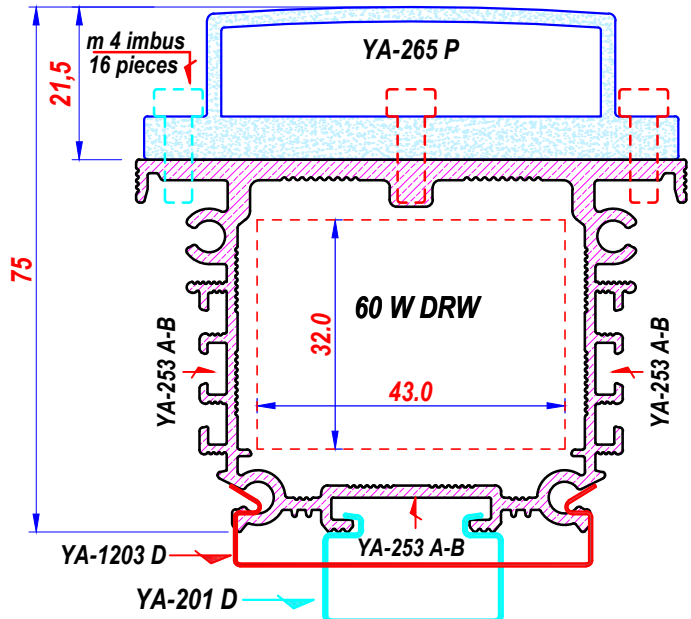
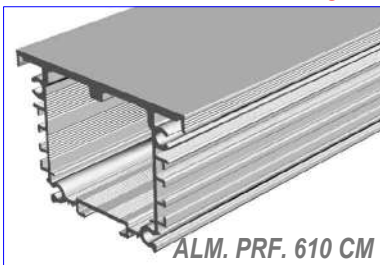
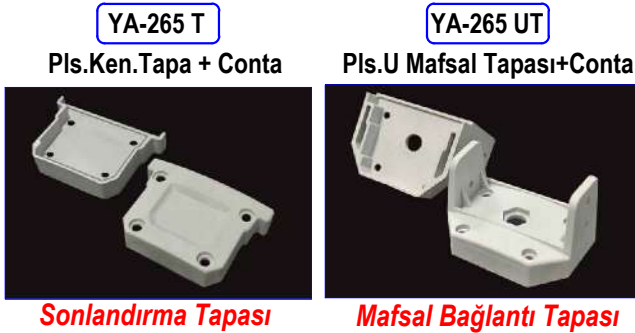

İstenilen ölçülerde kesim yapılır - İstenilen renge boyanır

YA-266 EKO

Alm. WW Kasa

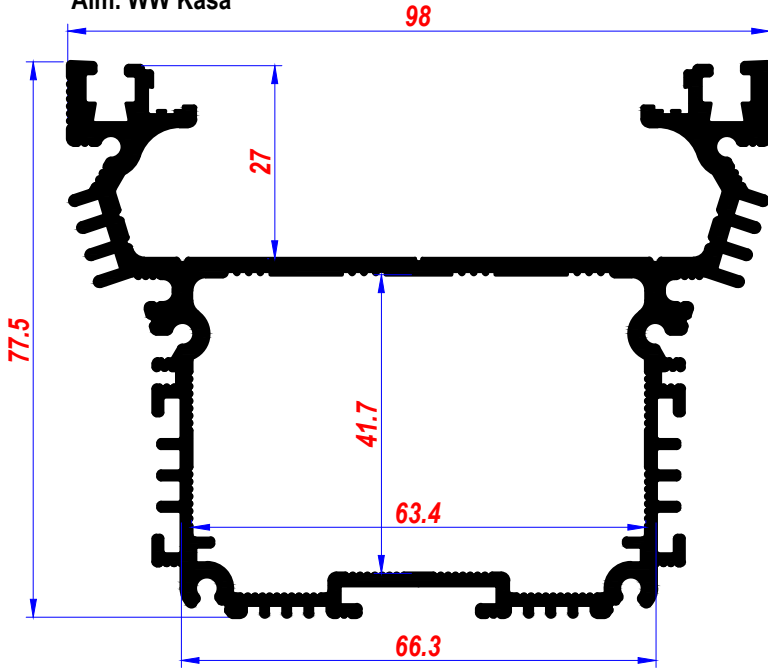

- Benzerlerinden daha ekonomik
- Yeni silikon cam fitili
- Üç noktadan ayak takabilme
- Çift sıra led kullanımına uygun
- Daha geniş driver alanı
- Dekoratif-slim Sokak Armatürü

YA-266 S

Alm. WW Kasa
Sokak Armatürü (Takım)

ürün takım rengi, Açık gri



YA-266 M

Metal Direk
Mafsalı



Elk.St.Boya-Renk Açık Gri

3 mm HRP Sac

YA-266 B 1

Pls.Kenar Tapa + Conta

Renk:A.Gri



Güçlendirilmiş Tapa

Cam çita profiliyle birlikte kullanılır

YA-266 Ç

YA-266 EKO



ALM. PRF. 610 cm

YA-266 A

Alm. Cam Çita Prf.

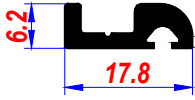

Fitil, cam çitasına takılıyor

YA-266 F

Silikon Cam Fitili



YA-255 PV

Polyamid
Havalandırma Ventili



Wallwasher - Projektör
Kasalarına uygun

YA-255 MV

Metal

MONTAJ

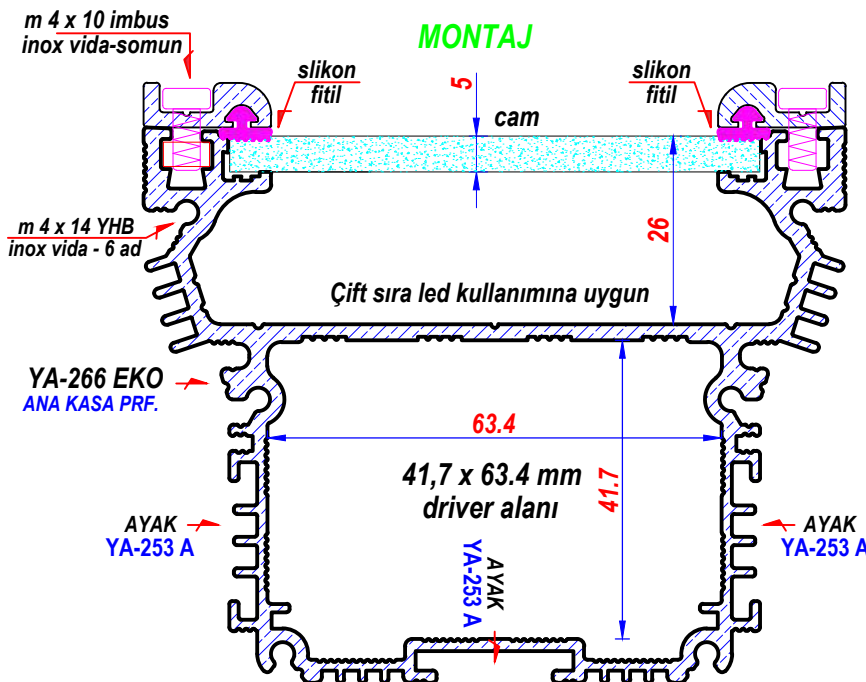

İstenilen ölçülerde kesim yapılır - İstenilen renge boyanır

All cutting dimensions and surface coatings can be done according to requirements

ALM. ENJEKSİYON SOKAK ARMATÜRÜ

YA-314

Sokak Arm. Kasa (Enj.)

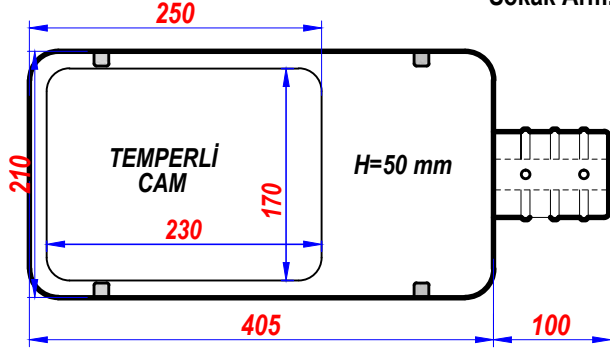

IP 66 - 100-120 W



KASA RENGİ - AÇIK GRİ

IP 66 - 100 W

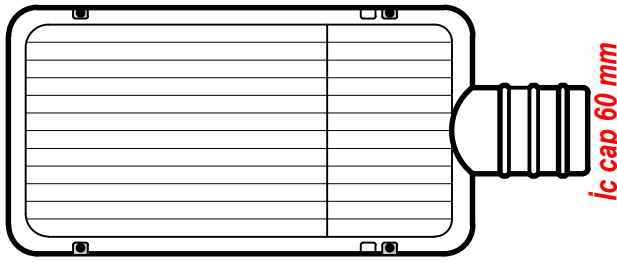

DRIVER Alanı : h=45,5 x 100x175 mm

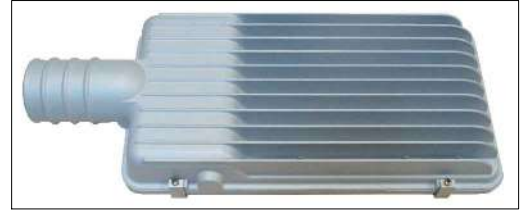

Müşteriye özel, PCB ve LED dizgi tasarımı yapılır

ALM. ENJEKSİYON PROJEKTÖR KASASI

YA-314 A

Projektör Kasası (Enj.)

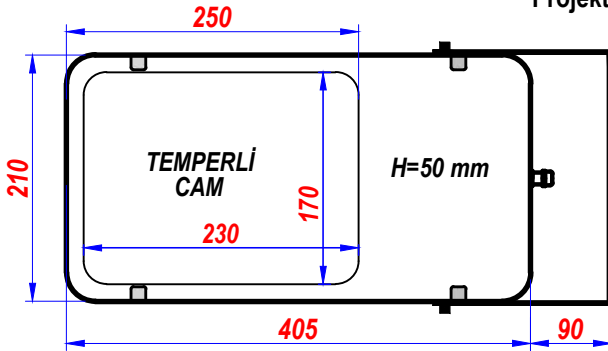

IP 66 - 100-120 W



KASA RENGİ - SİYAH

IP 66 - 100 W

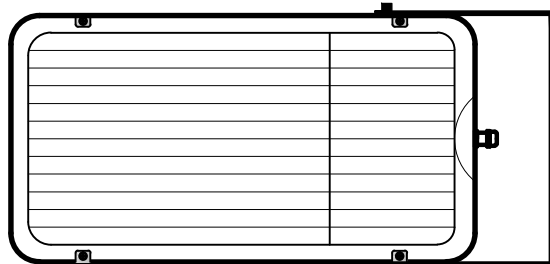

DRIVER Alanı : h=45,5 x 100x175 mm



Müşteriye özel, PCB ve LED dizgi tasarımı yapılır

İstenilen ölçülerde kesim yapılır - İstenilen renge boyanır
All cutting dimensions and surface coatings can be done according to requirements

YA-321

Kanopi Kasası
100-150 W KANOPI

ALM. ENJEKSİYON SOKAK ARMATÜRLERİ



IP 67- PC. Enjeksiyon DİFÜZÖR

Yüksek soğutma kapasitesine sahip

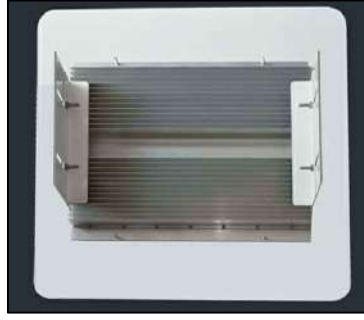

Alüminyum Ekstrizyon Soğutucu prf.

Elk.Statik boyalı 1,5 mm sac

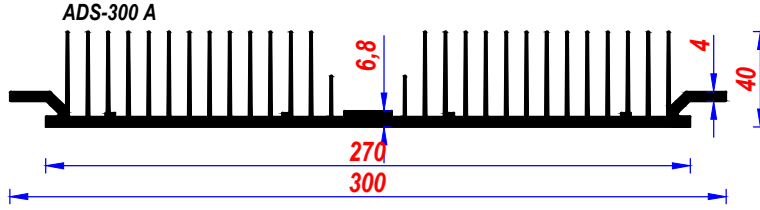
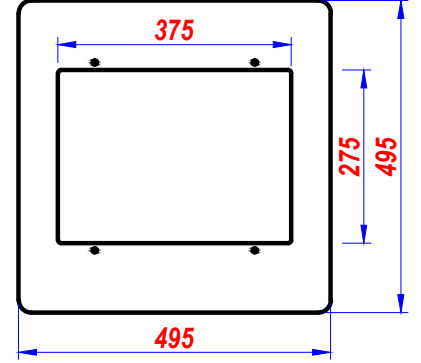

Kanopi kasasında kullanılan,
Yüksek soğutma kapasitesine sahip Alm. Ekst. Prf.

YA-1311 A



P.C. Enj. Cam+conta

YA-315 Enjeksiyon Sokak Aydınlatma Armatürü

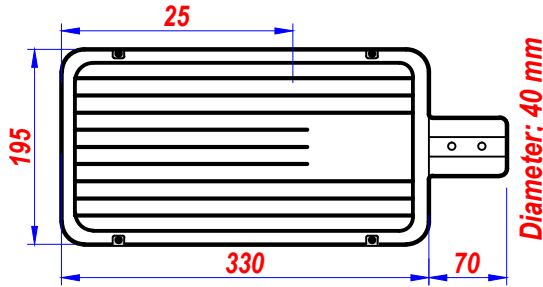
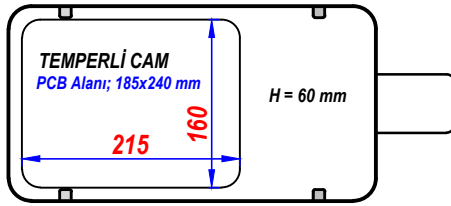

IP 66 - 50 W

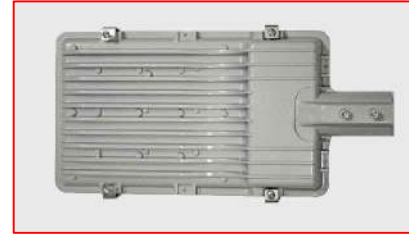

YA-315 A Enjeksiyon Projektör Armatürü

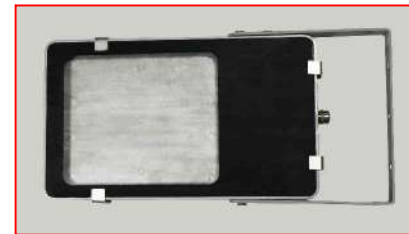
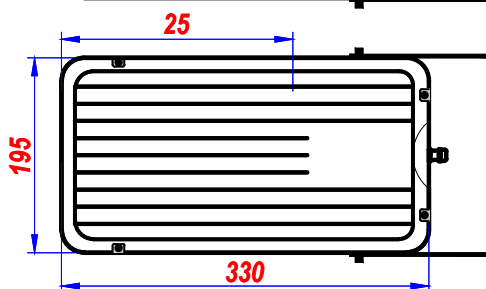
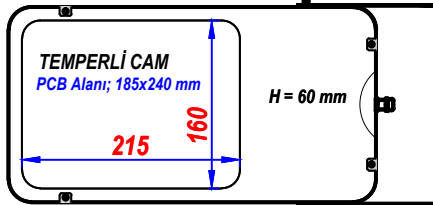

IP 66 - 50 W



İstenilen ölçülerde kesim yapılır - İstenilen renge boyanır

ALÜMİNYUM EKSTRÜZYON PROJKTÖR-SOKAK ARMATÜRÜ
POLİKARBON DİFÜZÖR

YA-1310

Alm.Led Prj.Kasa
PC. Enj.Difüzör
50-75 Watt
Pcb alanı:140x235 mm

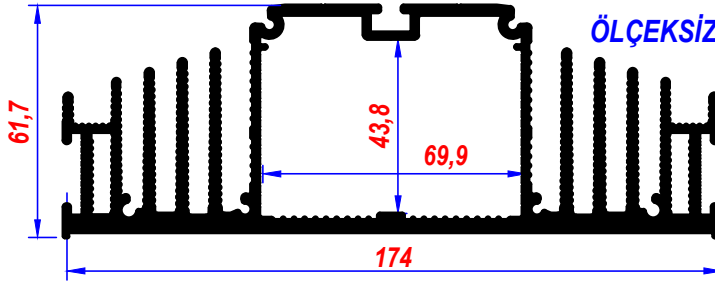

YA-1310 P

Projktör Kasa
Takım

IP 66, 50-75 Watt

YA-1310 S

Sokak Arm. Kasa
Takım

Pcb alanı:140x235 mm

YA-1310 P

Prprojktör Kasa-Takım

IP 66 - 50-75 Watt



PC. Enj.Difüzör

GENŐ ;174 mm UZUN ;280 mm

- * IP 66 korumalı, ekonomik PROJKTÖR ve SOKAK armatürü
- * Minimum ağırlık, kolay işçilik
- * Geniş driver alanı ; 43,8 x 69,9 mm
- * Pcb alanı ; 140 x 235 mm
- * Kenar tapa, U ayak HRP sac 3 mm, açık gri, elektro statik toz boya
- * Faturalı, elastron, sızdırmaz kenar tapa contası
- * Kenar tapada sızdırmaz 2 Őer ad IP 66, 6 mm kör somun perçin uygulaması
- * Yan yana 2 veya 3 sıra cam uygulama imkanı ; YA-1310 2 50 + 50 = 100 watt
- * Ürünlerle birlikte, U ayak, veya direk Mafsalı,Ken. tapa,conta,inox vidalar, IP 68 PG 7 metal rakor gönderilir.
- * Alüminyum Profil uzunluęu, 400 cm dir
- * Tünel aydınlatmaya uygun

YA-1310 S

Sokak Armatürü

IP 66 - 50-75 Watt



GEN;174 mm UZUN;280 mm

YA-1310 B

Metal Ken.Tapa

Projktörde kullanılır



2,5 mm PASLANMAZ SAC

YA-1310 A

P.C. Enj. Cam+conta (silikon)



Transparent

DİF ; 170 x 270 mm

YA-1320 U

Metal U-Bracket



Standard Width;32 cm

3 mm HRP Sheet-E.Static Painting

YA-1320 L

Metal L-Bracket



Yükseklik: 120 mm

YA-1310 C

Ken.Tapa Contası

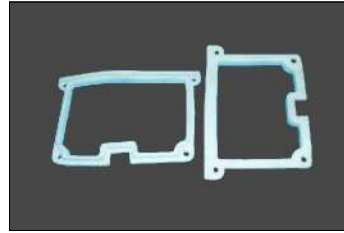

Elastron Conta - Naturel

YA-1310 M

Metal Direk Mafsalı



İkili takım - Renk A.Gri

3 mm HRP sac-E.Stk. boya

YA-1310 Y2

Yatay İkili Projktör



EN:174 mm-BOY:560 mm

PC Cam YA-1310 A

YA-1310 Alm.Kullanılır

YA-1310 Kasaya,YA-1310 A PC.
İki adet yatay cam uygulaması

YA-1310 T

Metal Ken.Tapa

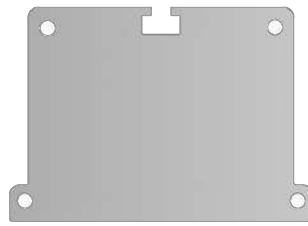

2,5 mm PASLANMAZ SAC
Sokak Armatüründe Kullanılır

YA-1310 D2

Dikey İkili Projktör

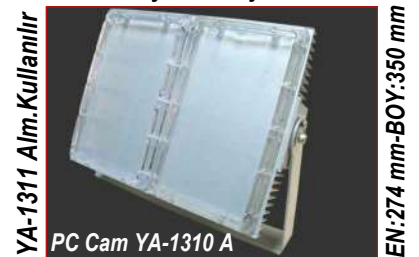

YA-1311 Alm.Kullanılır

PC Cam YA-1310 A

YA-1311 Kasaya,YA-1310 A PC.
İki adet dikey cam uygulaması

EN:274 mm-BOY:350 mm

İstenilen ölçülerde kesim yapılır - İstenilen renge boyanır

All cutting dimensions and surface coatings can be done according to requirements

ALÜMİNYUM EKSTRÜZYON PROJEKTÖR-SOKAK ARMATÜRÜ
POLİKARBON DİFÜZÖR

YA-1311

Alm.Led Prj.Kasa
PC. Enj.Difüzör
100 watt
Pcb alanı:240x340 mm

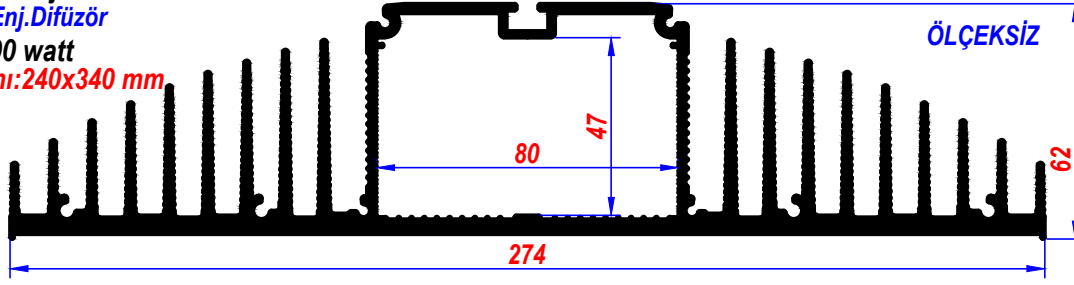

YA-1311 S

Sokak Arm. Kasa
PC. Enj.Difüzör
IP 66 - 100 watt

YA-1320 S

Sokak Arm. Kasa
Takım

YA-1311 P

Projektör Kasası-Takım

Pcb alanı:240x340 mm



EN:274 mm - BOY:380 mm

- * IP 66 korumalı, ekonomik PROJEKTÖR ve SOKAK armatürü
- * Benzerlerinden daha fazla soğutma kapasitesine sahip,
- * Minimum ve kolay işçilik
- * Geniş driver alanı; 47 x 80 mm
- * Pcb alanı ; 240 x 340 mm
- * Kenar tapada sızdırmaz IP 66, birer ad somun perçin kullanılmıştır.

YA-1311 S

Sokak Armatürü



EN:274 mm - BOY:380 mm

Pcb alanı:240x340 mm

YA-1311 A

P.C. Enj. Cam+conta (silikon)



DİF ; 170 x 270 mm

- * 2 veya 3 sıra cam uygulama imkanı, YA-1311 2 100 + 100 = 200 watt
- * Ürünlerle birlikte, U ayak, veya direk Mafsalı,Ken. tapa,conta,inox vidalar, IP 68 PG 9 metal rakor gönderilir.
- * IP 66 Su sızdırmaz, Polycarbon difüzör
- * Tünel aydınlatmaya uygun
- * Ürünlerin yeni enjeksiyon Kenar tapa
- * Alüminyum Profil uzunluğu, 400 cm dir

YA-1311 B

Metal Ken.Tapa



2,5 mm PASLANMAZ SAC

Projektörde kullanılır

YA-1311 U

Metal U-Bracket



Standard Width;32 cm

YA-1311 L

Metal L-Bracket



Height: 120 mm

YA-1311 C

Ken.Tapa Contası

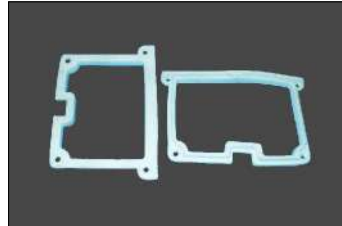

Elastron Conta - Naturel

YA-1311 M

Metal Direk Mafsalı



3 mm HRP sac-E.Sık. boya

İkili takım-Renk A.Gri

YA-1311 Y2

Yatay İkili Projektör



EN:274 mm-BOY:780 mm

PC CAM 1311 P

YA-1311 P PC Kullanılır

YA-1311 Kasaya,YA-1311 P PC. İki adet yatay cam uygulaması

YA-1311 T

Metal Ken.Tapa



3 mm HRP sac-E.statik boya
Sokak Armatüründe Kullanılır

İstenilen ölçülerde kesim yapılır - İstenilen renge boyanır

ALÜMİNYUM EKSTRÜZYON PROJEKTÖR-SOKAK ARMATÜRÜ
POLİKARBON DİFÜZÖR

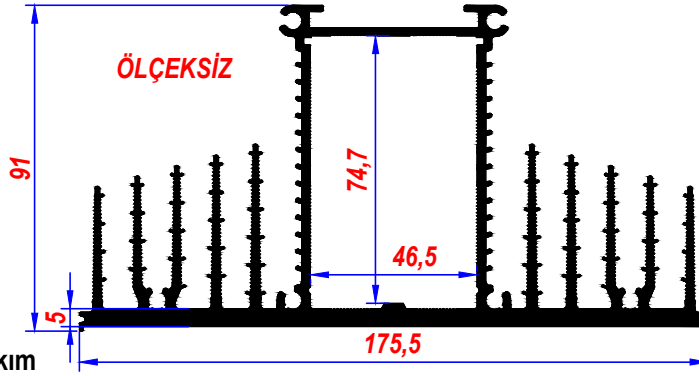

YA-1320

Alm.Led Prj.Kasa
PC. Enj.Difüzör
75-100 Watt
Pcb alanı:140x235 mm

YA-1320 P

Projektör Kasası
Takım
IP 66, 75-100 Watt

YA-1320 S

Sokak Arm. Kasa
Takım
Pcb alanı:140x235 mm

YA-1320 P

Projektör Kasası-Takım



EN:175,5 mm - BOY:280 mm
IP 66 - 75-100 Watt

YA-1320 S

Sokak Armatürü



EN:175,5 mm - BOY:280 mm

IP 66 - 75-100 Watt

YA-1320 T

Pls.Kenar Tapa



Güçlendirilmiş Plastik-Açık Gri

YA-1310 A

P.C. Enj. Difüzör+conta



PC.CAM ; 170 x 270 mm

- * IP 66 korumalı yeni ve ekonomik, PROJEKTÖR ve SOKAK armatürü
- * Minimum ağırlık, kolay işçilik
- * Benzerlerinden daha yüksek, soğutma kapasitesine sahip,
- * Geniş driver alanı ; 46,5 x 74,7 mm
- * Pcb alanı ; 140 x 235 mm
- * Sokak lambası mafsalı ve U ayak, HRP sac 3 mm, açık gri, elektro statik toz boyalıdır
- * Faturalı, elastron, sızdırmaz kenar tapa contası
- * Yeni güçlendirilmiş, IP 66 korumalı, sızdırmaz Pls.Kenar Tapa
- * Yan yana 2 veya 3 sıra PC. uygulama
- * Tünel aydınlatmaya uygun
- * Sokak armatürün yeni direk mafsalı yakında satışa sunulacaktır.
- * Tünel aydınlatmaya uygun
- * Ürünlerle birlikte, U ayak, veya direk Mafsalı,Ken. tapa,conta,inox vidalar, IP 68 PG 7 metal rakor gönderilir.
- * Alüminyum Profil uzunluğu, 400 cm dir

YA-1311 U

Metal U-Bracket



3 mm HRP sac-E.Stk. boya

YA-1311 L

Metal L-Bracket



Standart Gen.32 cm

YA-1320 P



Takım, Arka görünüş

YA-1320 C

Ken.Tapa Contası



Elastron Conta-Naturel

YA-1320 M

Metal Direk Mafsalı



İkili takım-Renk A.Gri

3 mm HRP sac-E.Stk. boya

YA-1320 P2

Yatay İkili Projektör



EN:175,5 mm-BOY:560 mm

YA-1320 Alm.Kullanılır

YA-1320 Kasaya, YA-1311 P PC.
İki adet yatay cam uygulaması

İstenilen ölçülerde kesim yapılır - İstenilen renge boyanır

SOĞUTMA KAPASİTESİ YÜKSEK
YA-1320 PROJEKTÖR - SOKAK ARM. KASASI

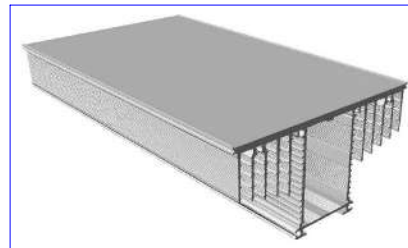

ALÜMİNYUM EKSTRÜZYON PROJEKTÖR-SOKAK ARMATÜRÜ
POLİKARBON DİFÜZÖR

YA-1321

Alm.Led Prj.Kasa
PC. Enj.Difüzör
100-150 Watt
Pcb alanı;240x340 mm

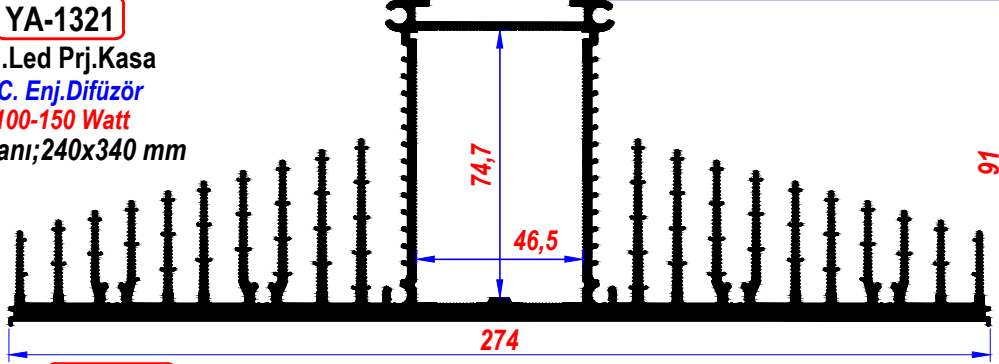

YA-1321 P

Projektör Kasası
Takım
IP 66 100-150 Watt

YA-1321 S

Sokak Arm. Kasa
Takım
Pcb alanı;240x340 mm

YA-1321 P

Projektör Kasası-Takım



EN:274 mm - BOY:380 mm
IP 66 - 100-150 Watt

YA-1311 A

P.C. Enj. Difüzör+conta



PC.;270x370 mm

- * IP 66 korumalı, yeni ekonomik PROJEKTÖR ve SOKAK armatürü
- * Minimum ağırlık, kolay işçilik
- * Benzerlerinden daha yüksek, soğutma kapasitesine sahip,
- * Geniş driver alanı ; 46,5 x 74,7 mm
- * Pcb alanı ; 240 x 340 mm x 2 ad.
- * Sokak lambası mafsalı ve U ayak, HRP sac 3 mm, açık gri, elektro statik toz boyalıdır
- * Faturalı, elastron, sızdırmaz kenar tapa contası
- * Yeni güçlendirilmiş, IP 66 korumalı, sızdırmaz Pls.Kenar Tapa
- * Yan yana çoklu PC. Cam uygulama
- * Sokak armatürün yeni direk mafsalı yakında satışa sunulacaktır.
- * Tünel aydınlatmaya uygun
- * Ürünlerle birlikte, U ayak, veya direk Mafsalı,Ken. tapa,conta,inox vidalar, IP 68 PG 9 metal rakor gönderilir.
- * Alüminyum Profil uzunluğu, 400 cm dir

YA-1321 P2

İkili Projektör Takım



EN:274 mm - BOY:800 mm
YA-1321 Kasaya,YA-1311 P PC.
İki adet yatay cam uygulaması

YA-1321 S

Sokak Armatürü



EN:274 mm - BOY:380 mm

Pcb alanı:240x340 mm

YA-1321 U

Metal U-Bracket



3 mm HRP sac-E.Stk. boya

YA-1321 L

Metal L-Bracket



Standart Gen.32 cm

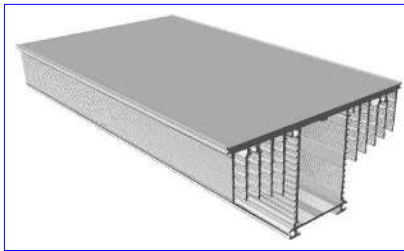

İSTENİLEN ÖLÇÜLERDE KESİM YAPILIR
SOĞUTMA KAPASİTESİ YÜKSEK, yeni
YA-1321 PROJEKTÖR-SOKAK ARM. KASASI

YA-1320 T

Pls.Kenar Tapa



Güçlendirilmiş Plastik-Açık Gri

YA-1321 M

Metal Direk Mafsalı



İkili takım-Renk A.Gri

3 mm HRP sac-E.Stk. boya

YA-1320 P2 Yatay İkili Projektör

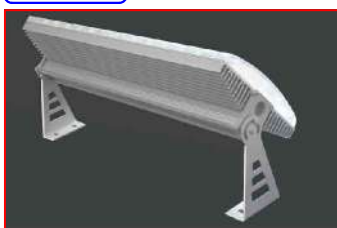

YA-1321 P2-İKİLİ TAKIM

IP 66 - 250-300 Watt

YA-1321 P



Takım, Arka görünüş

YA-1320 C

Ken.Tapa Contası



Elastron Conta-Naturel

ALÜMİNYUM EKSTRÜZYON PROJEKTÖR- KÜÇÜK

YA-1300 Y

Alm.Led Prj.Kasa
IP 66 - 75 Watt

YA-1300 P

Projektör Kasası (Set halinde)



Metal U Ayak

30 cm ; IP 66 - 50-75 Watts



Yüks: YA-253 C 75 mm

Lux Ayak Seti

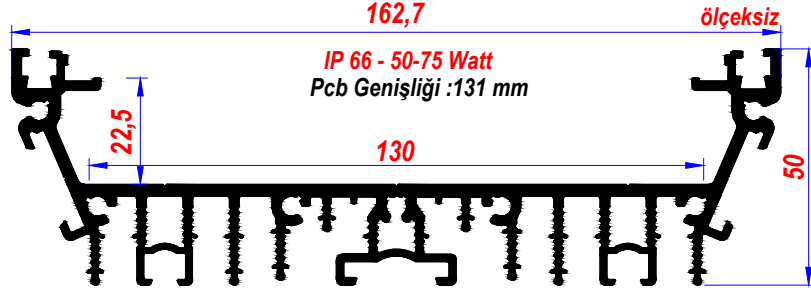

PROJEKTÖR VE SOKAK ARMATÜRÜ ne UYGUN, IP 66 YAPILABİLECEK,

YA-1300 S

Sokak Aydınlatması



Ekstrüzyon Kasa

IP 66 - 50-75 Watts at 30 cm

YA-1300 T

Plastik Tapa



Açık Gri

Güçlendirilmiş Plastik Tapa

YA-1300 C

Ken.Tapa Contası

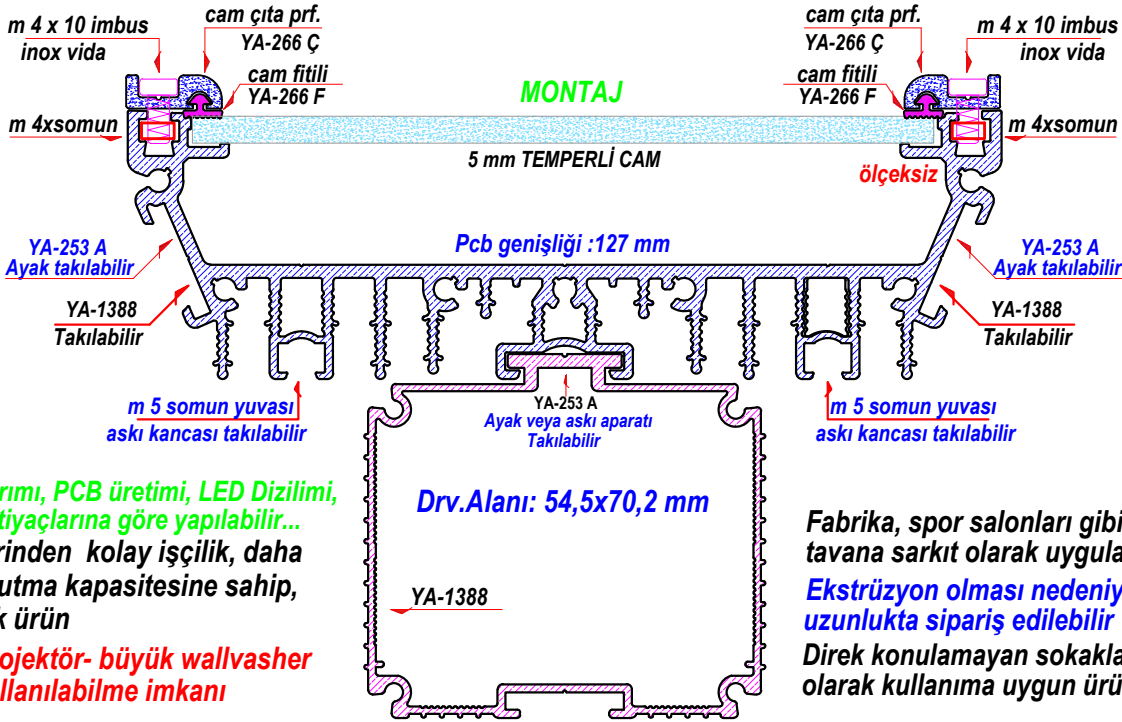

Driver takılı top. yükseklik H=120 mm

PCB Tasarımı, PCB üretimi, LED Dizilimi,
Müşteri ihtiyaçlarına göre yapılabilir...

Benzerlerinden kolay işçilik, daha fazla soğutma kapasitesine sahip, ekonomik ürün

Küçük projektör- büyük wallwasher olarak kullanılabilme imkanı

Fabrika, spor salonları gibi, yerlerde tavana sarkıt olarak uygulanır
Ekstrüzyon olması nedeniyle istenilen uzunlukta sipariş edilebilir
Direk konulamayan sokaklarda, sarkıt olarak kullanıma uygun ürün...

YA-1388

Alm. Driver Prf.

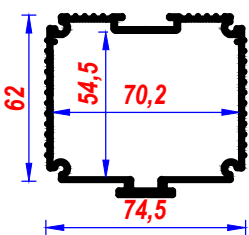

YA-1388 A

Alm.Prf.Tp.

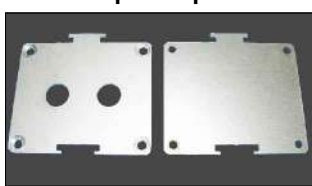

YA-1388 C

Tapa Contası

YA-266 C

Alm. Cam Çıta Prf.

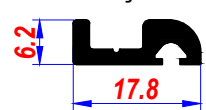

Fitil,cam çıta profiline takılır

YA-266 F

Silikon Cam Fitili



Standard Genişlik:32 cm

YA-1300 U

Metal U-Ayak



3 mm HRP Sheet-E.Static Painting

YA-1300 L

Metal L-Ayak



Yükseklik: 120 mm

İstenilen ölçülerde kesim yapılır - İstenilen renge boyanır
All cutting dimensions and surface coatings can be done according to requirements

ALÜMİNYUM EKSTRÜZYON PROJEKTÖR- ORTA

YA-1301

Alm.Led Prj.Kasa
Orta
75 Waat
Pcb genişliği:175 mm

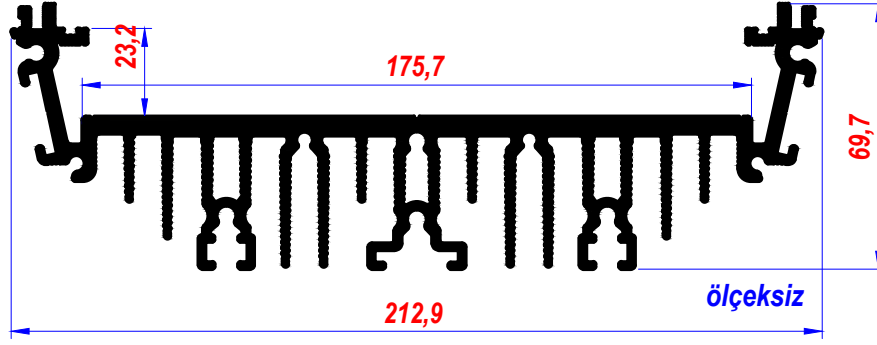

YA-1301 B

Metal Kenar Tapa



5 mm HRP sac-statik boya

YA-1301 C

Elastron Conta

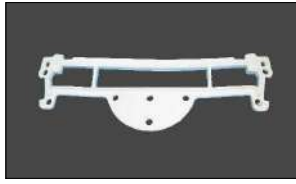

Elastron Beyaz conta

YA-1301 U

Metal U Ayak



Standart genişlik 32 cm
Farklı ölçülerde üretilebilir

YA-1300 A

Alm.Cam Çıta Prf.

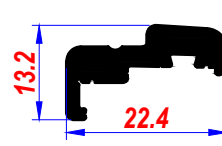

YA-1300 F

U Cam Fitolü



Silikon-Şeffaf

YA-1388 A

Alm. Kenar Tapa

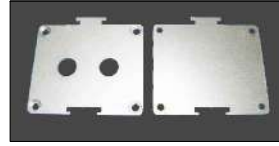

YA-1388 C

Kenar Tapa contası



Elastron Conta - Naturel

YA-1388

Alm. Driver Prf.

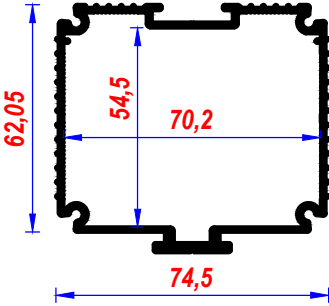

YA - 1301



PCB Genişliği ; 175 mm



30 cm uzunlukta; 75 watt

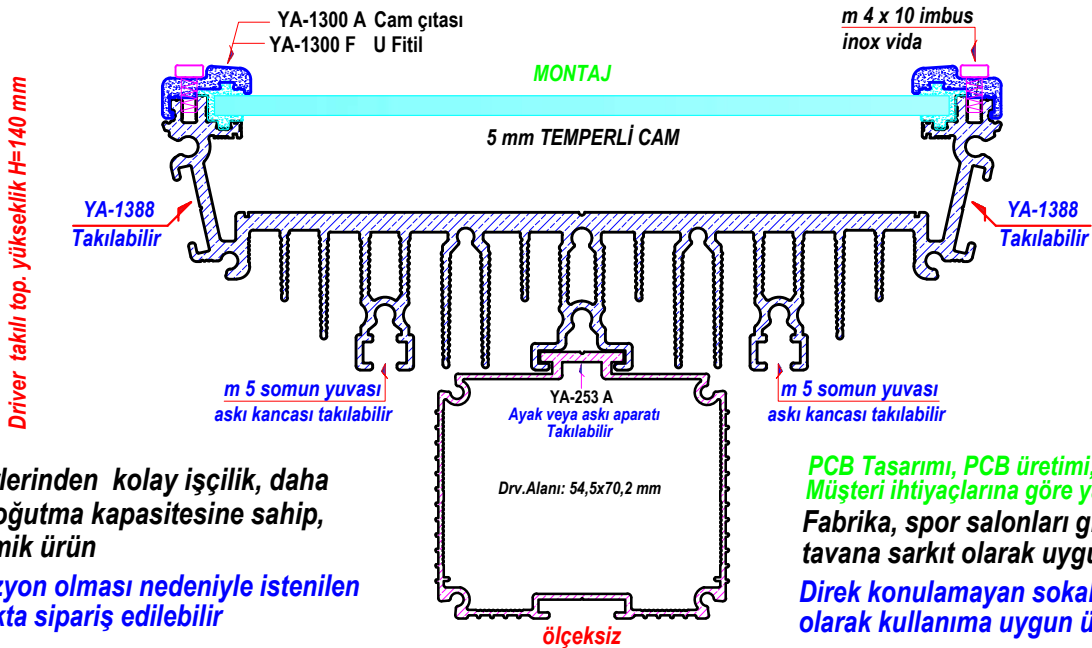

Benzerlerinden kolay işçilik, daha fazla soğutma kapasitesine sahip, ekonomik ürün

Ekstrüzyon olması nedeniyle istenilen uzunlukta sipariş edilebilir

PCB Tasarımı, PCB üretimi, LED Dizilimi, Müşteri ihtiyaçlarına göre yapılabilir...

Fabrika, spor salonları gibi, yerlerde tavana sarkıt olarak uygulanır

Direk konulamayan sokaklarda, sarkıt olarak kullanıma uygun ürün...

ALÜMİNYUM EKSTRÜZYON PROJEKTÖR
BÜYÜK BOŐ KASA

YA-1302

Alm.Led Prj.Kasa
Büyük
150-200 Waat
Pcb Geniřliđi:265 mm

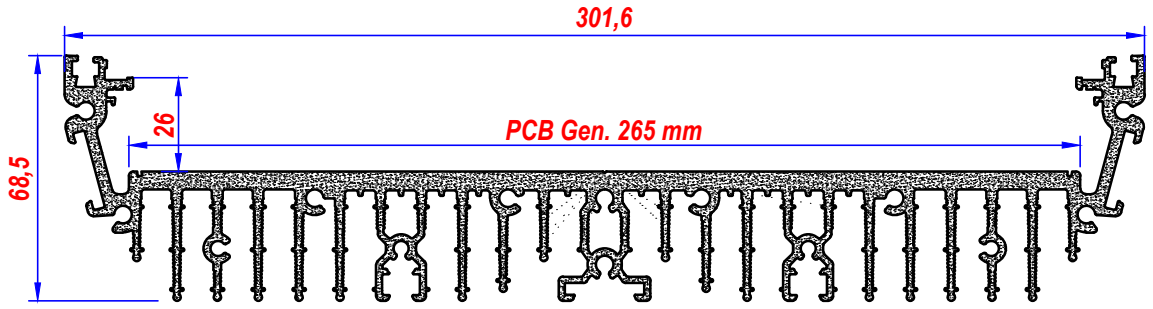

YA-1302 T

Metal Ken.Tapa

5 mm PASLANMAZ

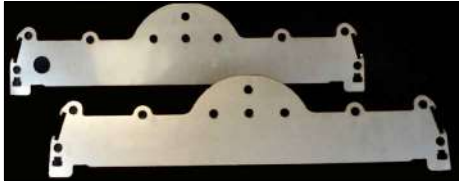

- * IP 66 korumalı, yeni ekonomik PROJEKTÖR kasası
- * Minimum ađırlık, kolay iŐçilik
- * Benzerlerinden fazla yüksek sođutma kapasitesine sahip, ekonomik ÜRÜN
- * GeniŐ driver alanı ; 54.5 x 70 mm
- * Pcb geniřliđi ; 265 mm
- * Yakında, IP 66 korumalı, Alm. Ken. Tapa
- * Mevcut 5 mm Paslanmaz Ken Tapa
- * Kasada PG 9 Rakor kullanılır

YA-1302 PROJEKTÖR KASASI

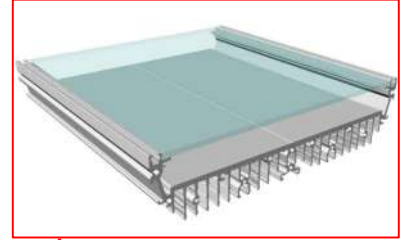

İstenilen ölçülerde ebatlanır

YA-1302 C

Kenar Tapa Contası
Kendinden YapıŐkanlı (PU)

SIYAH

Geniřlik : 20 mm



Yeni Alm. Enj. Kenar Tapa, yakında satıŐa sunulacaktır



YA-1388

Alm. Driver Prf.

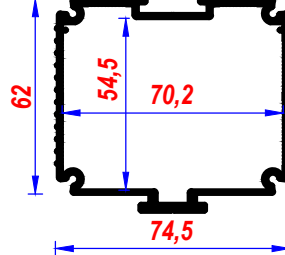

IP 66 YA-1302 P YAKINDA
Projektör Kasası (Set halinde)

Metal U Ayak 32 cm



32 cm 150-200 Watt aralıđı

YA-266 Ç

Alm. Cam Çıta Prf.

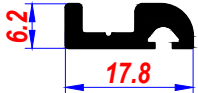

Fitil,cam çıta profiline takılır

YA-266 F

Silikon Cam Fitili



YA-1302 U

Metal U-Ayak

Standard Gen: 32 cm



3 mm HRP Sac-E.Satatik-Açık Gri

YA-1302 L

Metal L-Ayak



YA-1388 C

Driver Tapa contası



YA-1388 A

Alm. Kenar Tapa

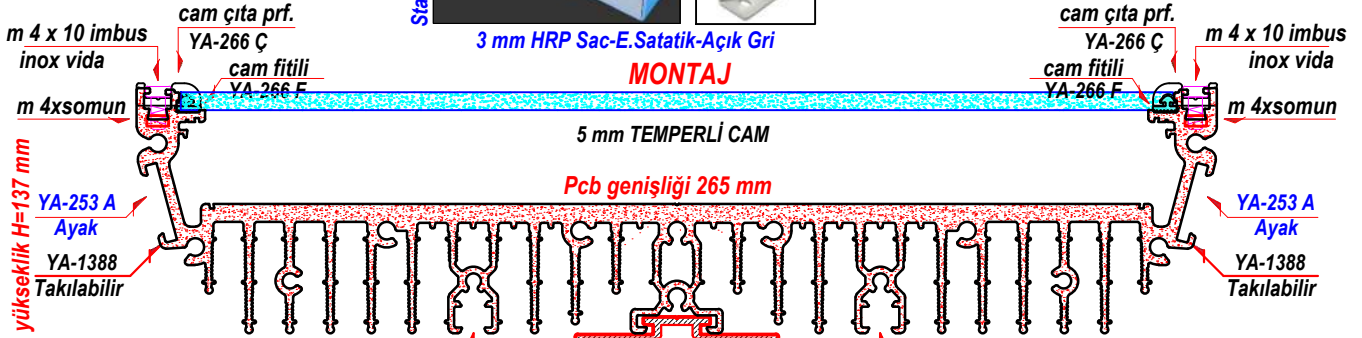

MONTAJ

5 mm TEMPERLİ CAM

Pcb geniřliđi 265 mm

Drv.Alanı: 54,5x70,2 mm

YA-1388

Benzerlerinden kolay iŐçilik, daha fazla sođutma kapasitesine sahip, ekonomik ürün
Ekstrüzyon olması nedeniyle istenilen uzunlukta sipariŐ edilebilir

PCB Tasarımı, PCB üretimi, LED Dizilimi, MüŐteri ihtiyaçlarına göre yapılabilir...
Fabrika, spor salonları gibi, yerlerde tavana sarkıt olarak uygulanır
Direk konulamayan sokaklarda, sarkıt olarak kullanıma uygun ürün...

RK - 004 Alm. Kayan Yazı Reklamı Prf.

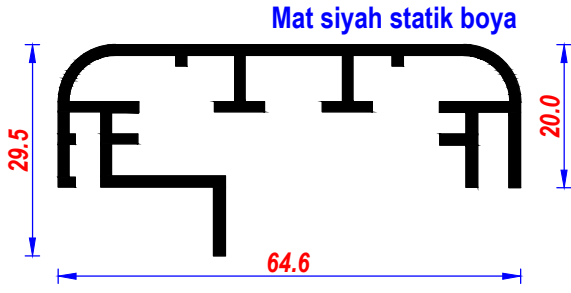

RK - 004

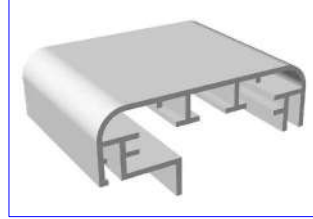

ALM.PR.F. 600 cm

RK-004 A

Plastik Köşe Birleřtirme

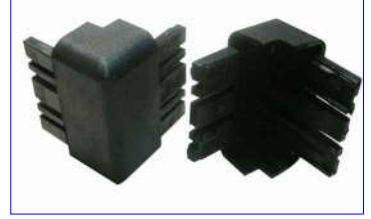

Renk siyah

RK - 005

Alm. Reklam-Tabela Prf

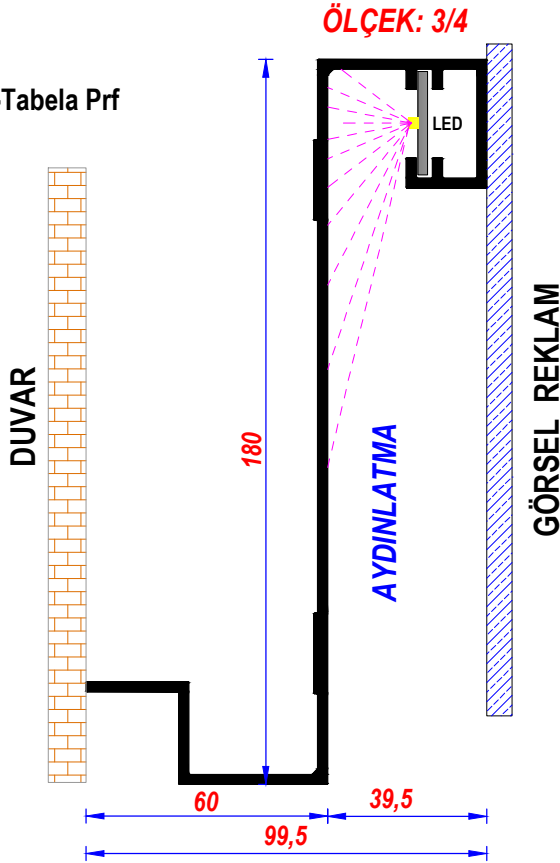

RK - 005

ALM.PR.F. 600 cm

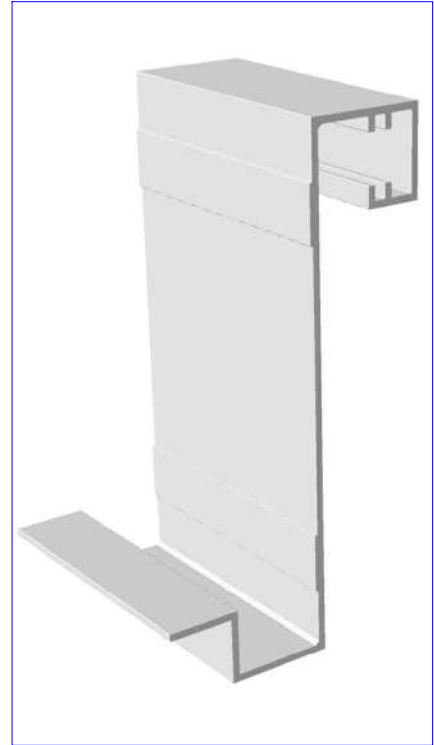

RK - 001

Alm. Reklam
Yönlendirme / Led Pef.

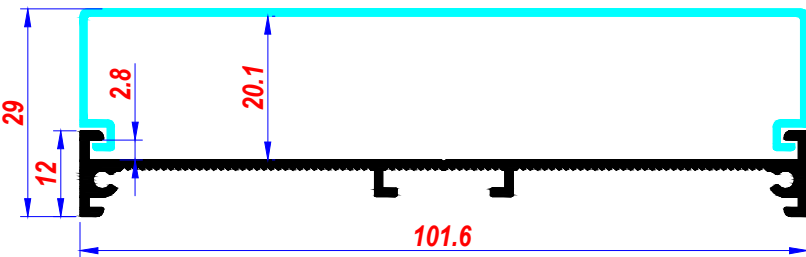

RK - 001A

P.C. Difüzör

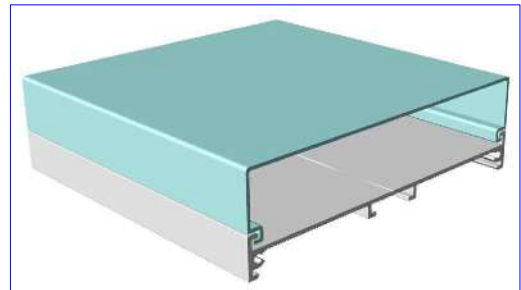

RK-001 T

Alm. Kenar Tapa

Ölçeksiz

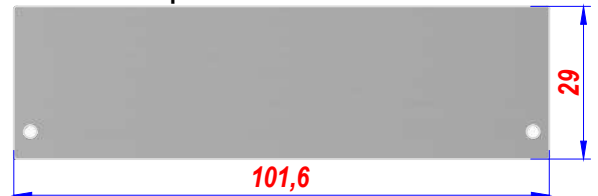

İstenilen ölçülerde kesim yapılır - İstenilen renge boyanır

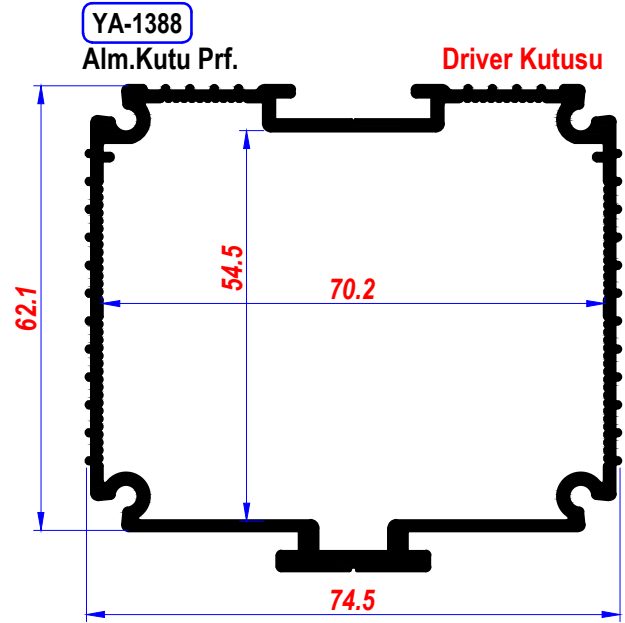
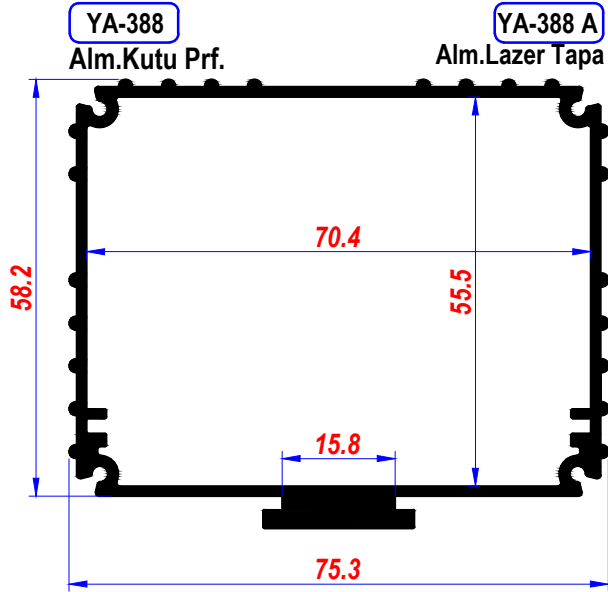
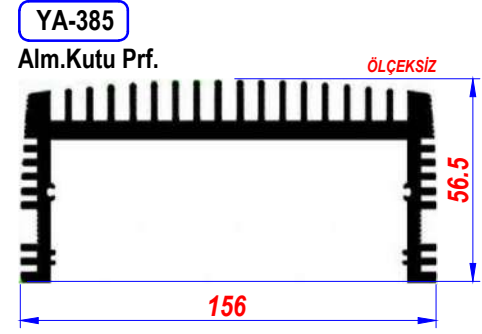
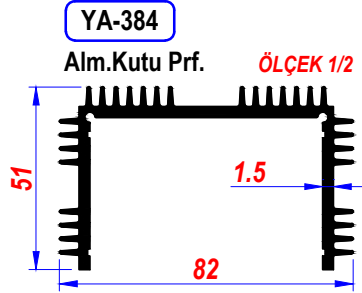
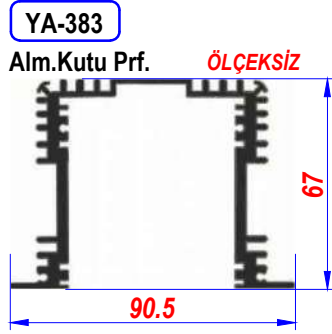
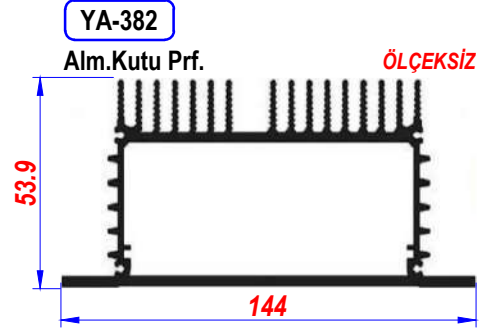
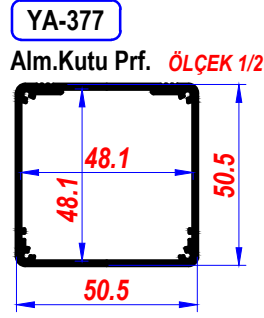
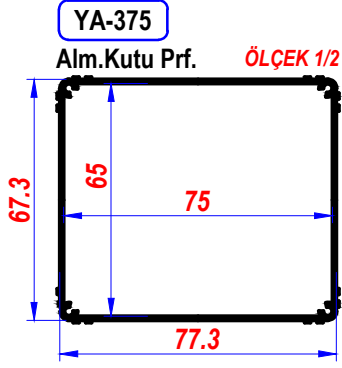

YA-1388 A
Alm. Kenar Tapa

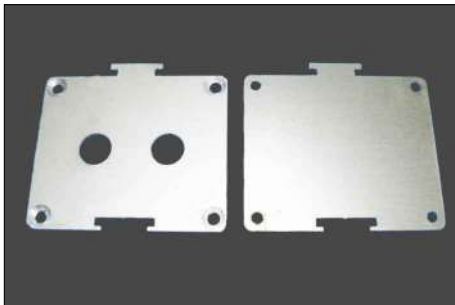

YA-1388 C
Ken.Tapa Contası

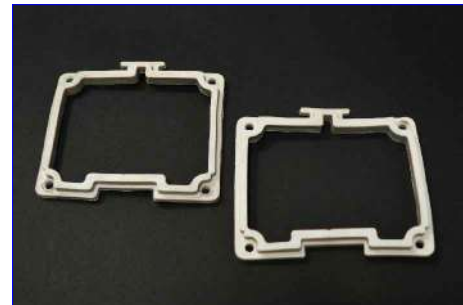

Elastron Conta - Naturel

İstenilen ölçülerde kesim yapılır - İstenilen renge boyanır

SİGMA PROFİL ve AKSESUARLARI İçin Bilgi alınız

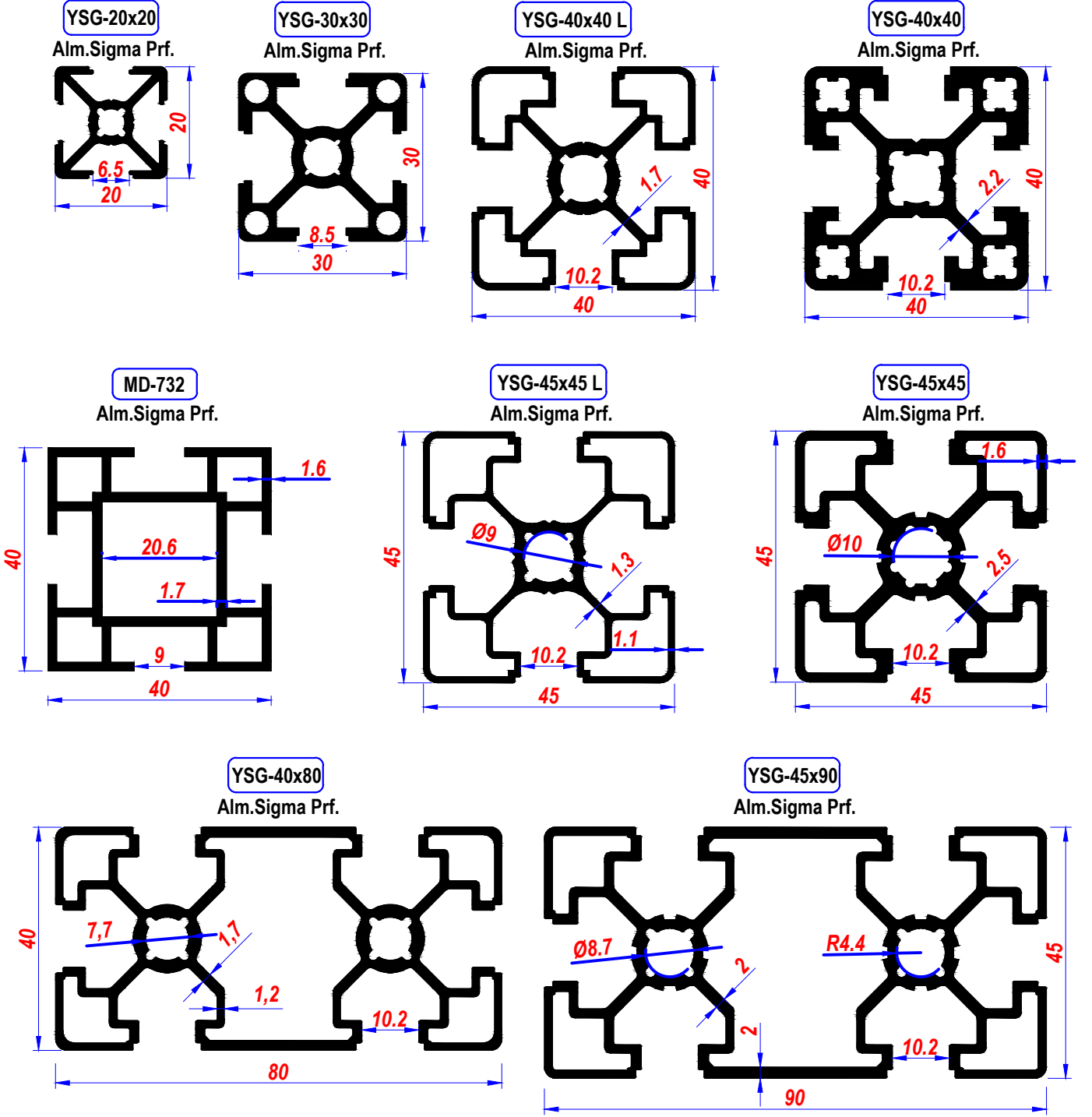

Katalogta olmayan modeller için bilgi alınız

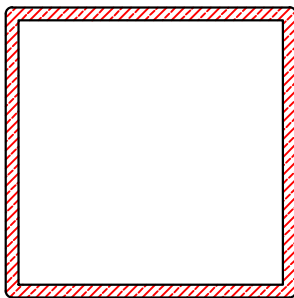

**KUTU / BORU Profilleri
Ölçüler için bilgi alınız**

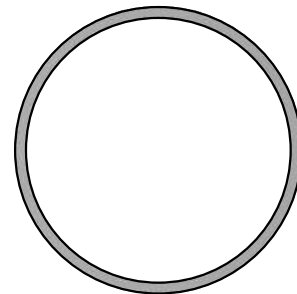

İstenilen ölçülerde kesim yapılır - İstenilen renge boyanır
All cutting dimensions and surface coatings can be done according to requirements

AYDS-75

75 mm Alm.Soğutucu Prf.

Ölçek 1/1

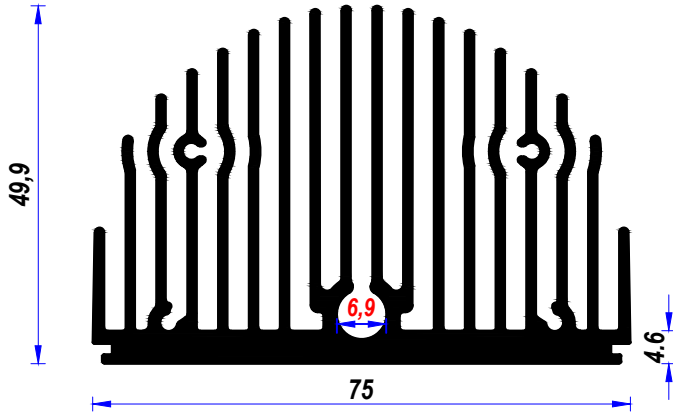

MODULE LENS UYGULAMA



METAL KENAR TAPA
METAL AYAK



MODÜL LENS
+ CONTA

AYDS-93

93 mm Alm.Soğutucu Prf.

Ölçek 1/1

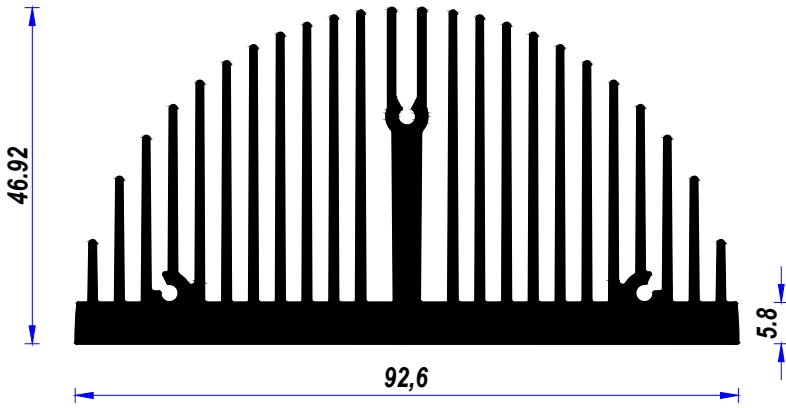

YA-265 P UYGULAMA



METAL KENAR TAPA
METAL AYAK



YA-265 P
PC.DİFÜZÖR
CONTA

AYDS-96

96 mm Alm.Soğutucu Prf.

Ölçek 1/1

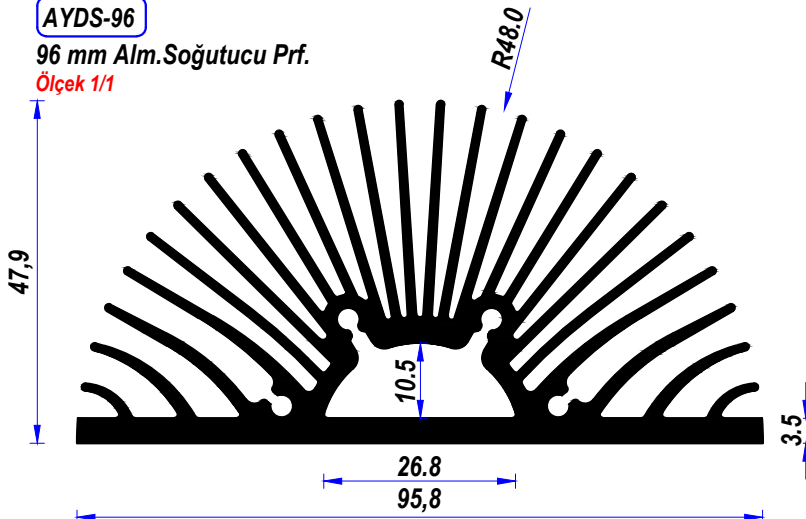

MODULE LENS UYGULAMA



METAL KENAR TAPA
METAL AYAK



MODÜL LENS
+ CONTA

Suitable for use as WallWasher, Floodlight and Street Light

İstenilen ölçülerde kesim yapılır - Renkli eloksallı kaplama yapılır

AYDS-96

96 mm Alm.Soğutucu Prf.
Ölçek 1/1

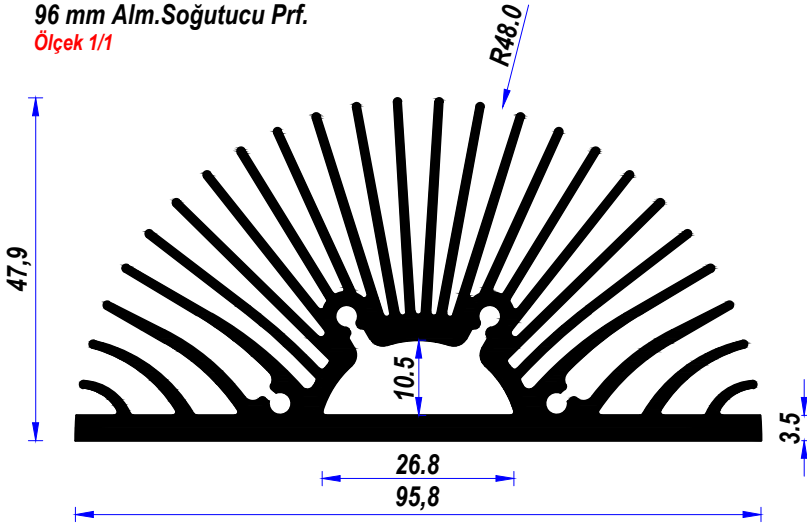

METAL KENAR TAPA
METAL AYAK



AYDS-96
MODÜL LENS
+ CONTA

Wallwasher, Projektör ve Sokak Aydınlatmada kullanılabilir

AYDS-96 3 lü UYGULAMA



Wallwasher modül lens uygulaması

MODÜL LENS - CONTA

LNS - 60° x 173
LNS - 90° x 173
LNS - AS. x 173



YA-229 RF

Pls.Reflektör (Siyah)

YA-229 LS

Lens-Mercek (Şeffaf)

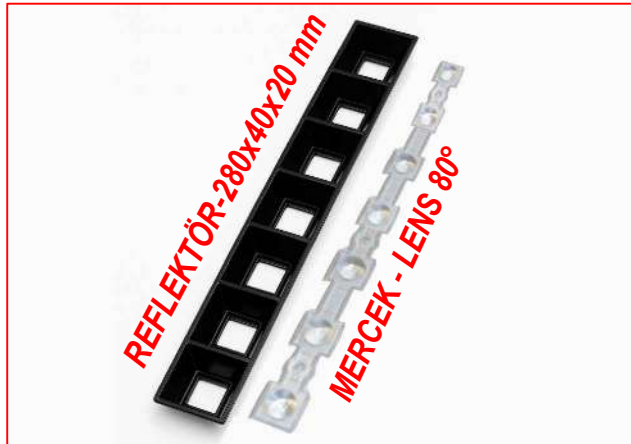

AYDS-96 Alm.profile yan yana iki sıra uygulanabilir

AYS - 25

Ø 25 mm Alm.Sğt.Prf.
Ölçek 1/1

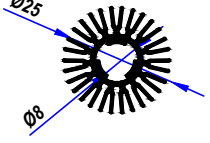

AYS - 30

Ø 30 mm Alm.Sğt.Prf.
Ölçek 1/1

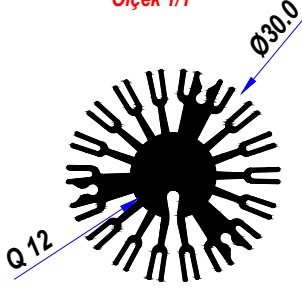

AYS - 35

Ø 35,6 mm Alm.Sğt.Prf.
Ölçek 1/1

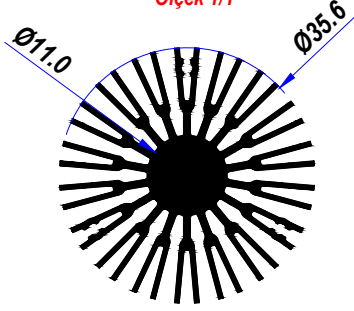

AYS - 47

Ø 47 mm Alm.Sğt.Prf.
Ölçek 1/1

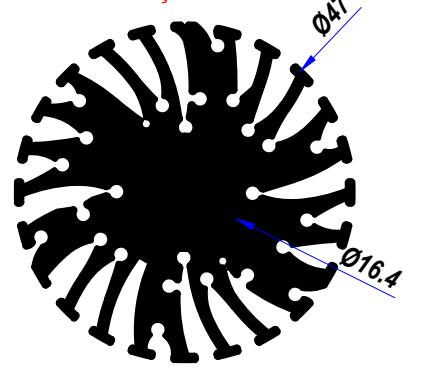

AYS - 50

Ø 50 mm Alm.Sğt.Prf.
Ölçek 1/1

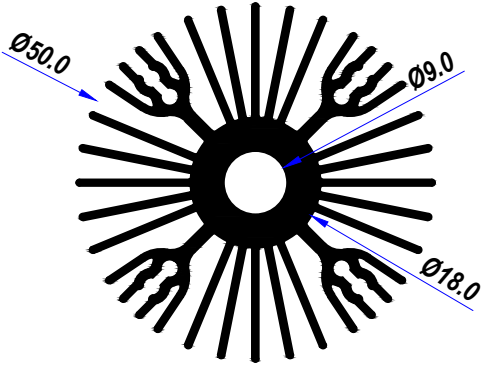

AYS - 52

Ø 52,5 mm Alm.Sğt.Prf.
Ölçek 1/1

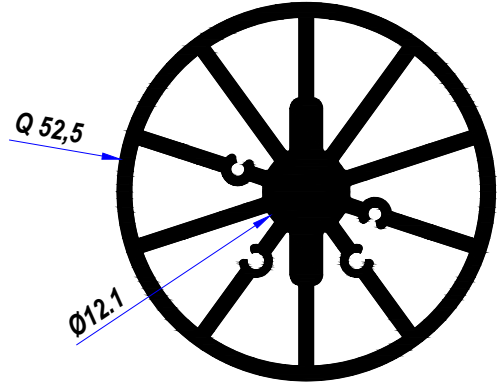

AYS - 60

Ø 60 mm Alm.Sğt.Prf.
Ölçek 1/1

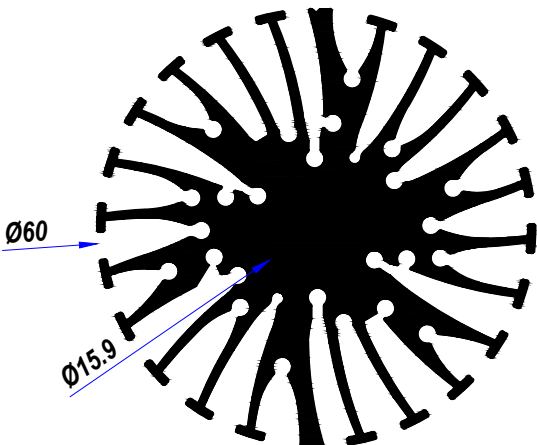

AYS - 61

Ø 61 mm Alm.Sğt.Prf.
Ölçek 1/1

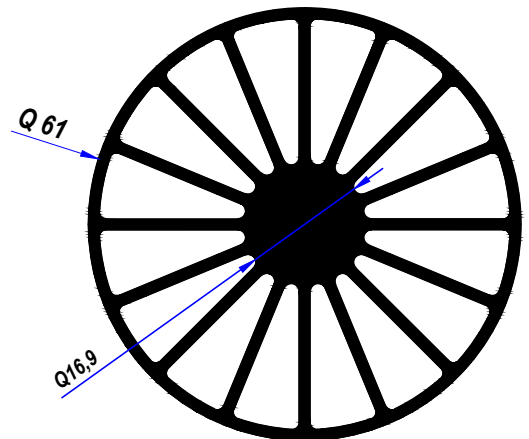

İstenilen ölçülerde kesim yapılır - Renkli eloksal kaplama yapılır
All cutting dimensions and surface coatings can be done according to requirements.

AYS-65 A

Ø 65 mm
Alm. Sğt. Prf.
Ölçek 3/4

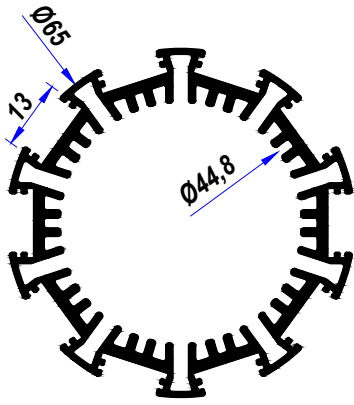

AVZ-002 P

PC. Difüzör

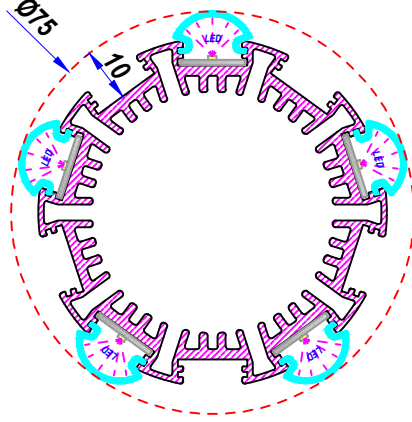

UYGULAMA 1

PC. Difüzör çapı minimum 100 mm
UYGULAMA 2

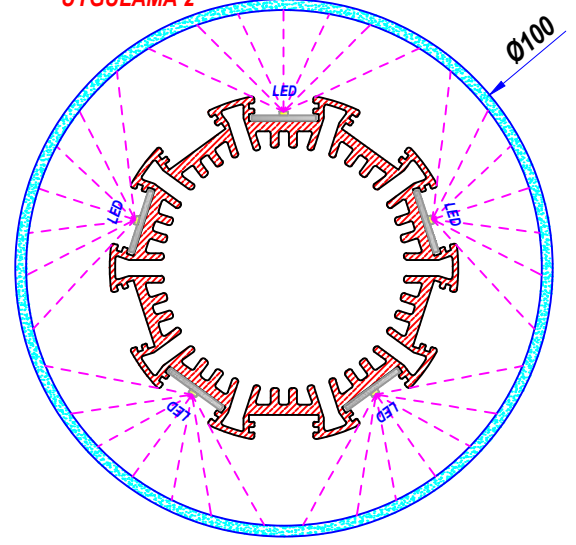

AYS - 65

Ø 65 mm
Alm. Sğt. Prf.
Ölçek 3/4

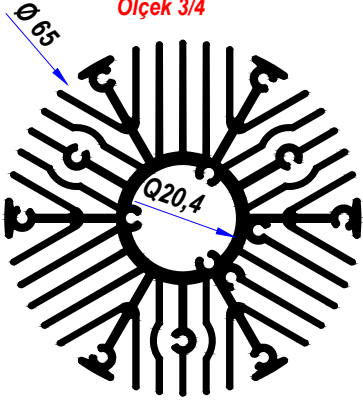

YENİ AYS - 67

Ø 67 mm
Alm. Sğt. Prf.
Ölçek 3/4

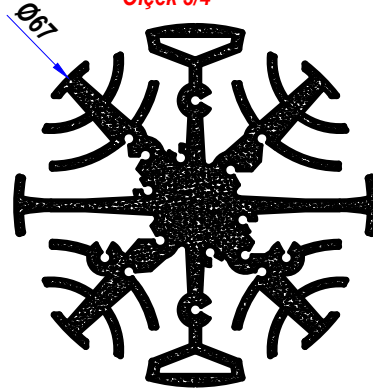

AYS - 70

Ø 70 mm
Alm. Sğt. Prf.
Ölçek 3/4

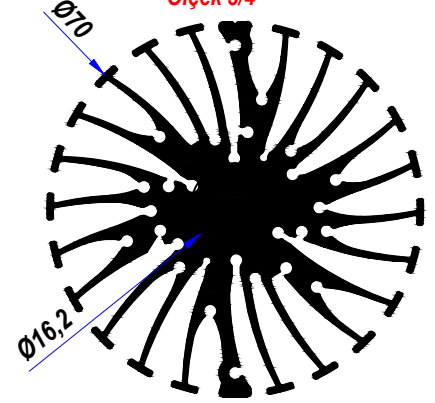

AYS - 80

Ø 80 mm
Alm. Sğt. Prf.
Ölçek 3/4

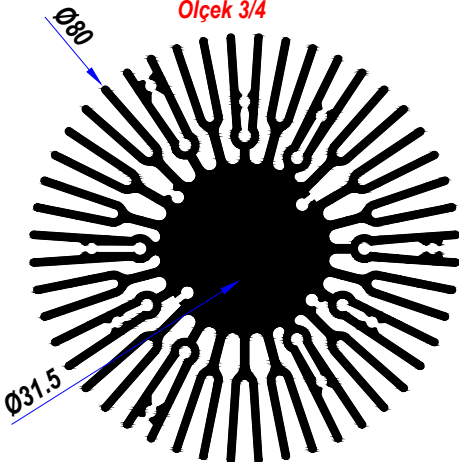

AYS - 80 A

Ø 80,5 mm
Alm. Sğt. Prf.
Ölçek 3/4

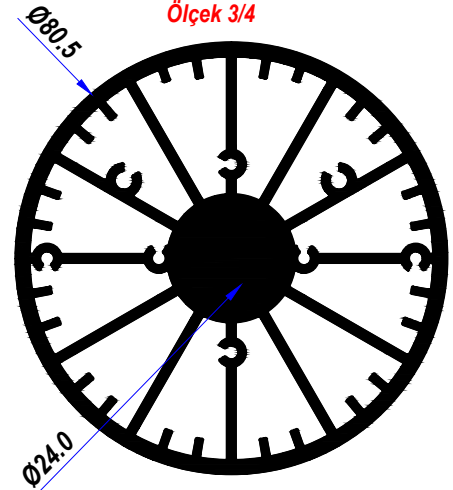

İstenilen ölçülerde kesim yapılır - Renkli eloksal kaplama yapılır
All cutting dimensions and surface coatings can be done according to requirements.

AYS - 86

Ø 86 mm Alm. Sğt. Prf.
Ölçek 3/4

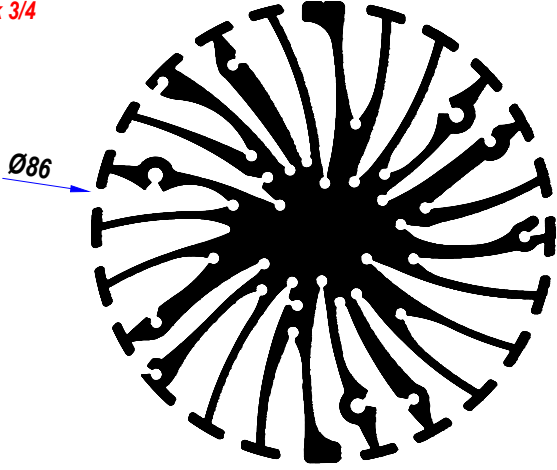

AYS - 89

Ø 89 mm Alm. Sğt. Prf.
Ölçek 3/4

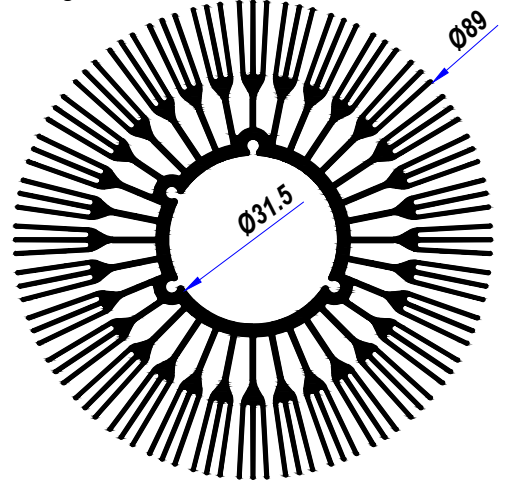

AYS - 90

Ø 90 mm Alm. Sğt. Prf.
Ölçek 3/4

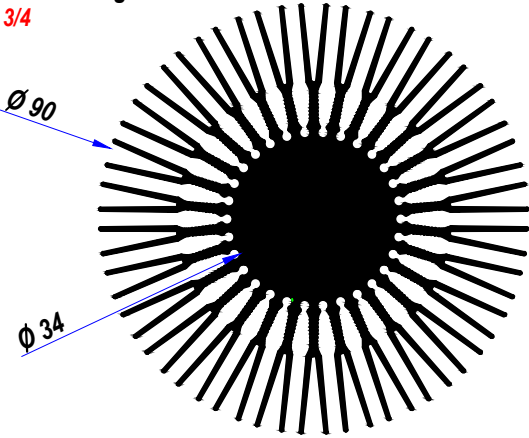

AYS - 92

Ø 92 mm Alm. Sğt. Prf.
Ölçek 3/4

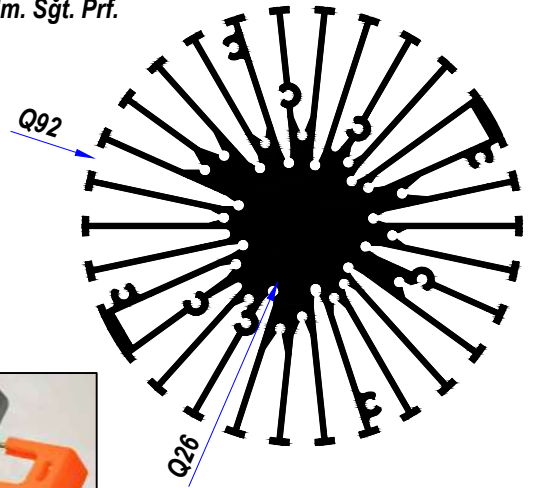

AVZ-BE 4

Led Spot Yayı



AYS - 95

Ø 95 mm Alm. Sğt. Prf.
Ölçek 3/4

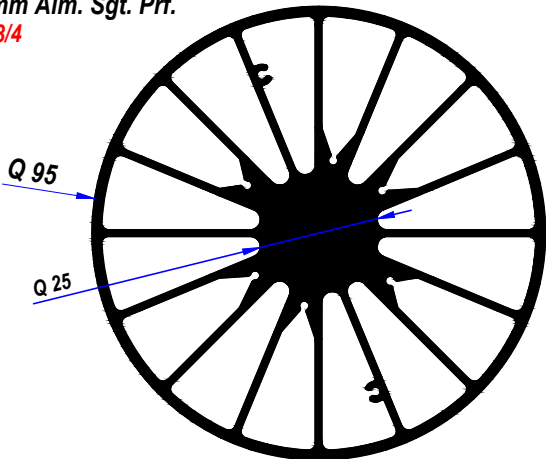

AYS - 99

Ø 99 mm Alm. Sğt. Prf.
Ölçek 3/4

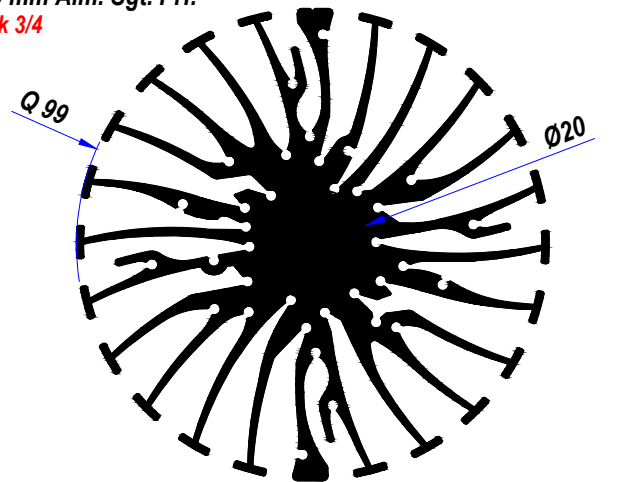

İstenilen ölçülerde kesim yapılır - Renkli eloksallı kaplama yapılır
All cutting dimensions and surface coatings can be done according to requirements.

AYS - 99 A

Ø 99 mm Alm. Sğt. Prf.
Ölçek 2/3

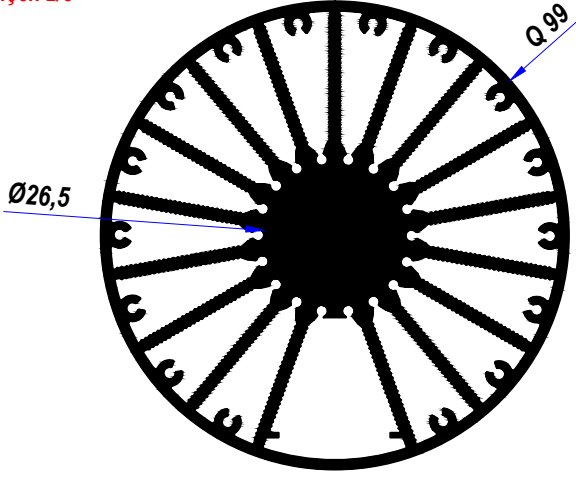

AYS - 100

Ø 100,5 mm Alm. Sğt. Prf.
Ölçek 2/3

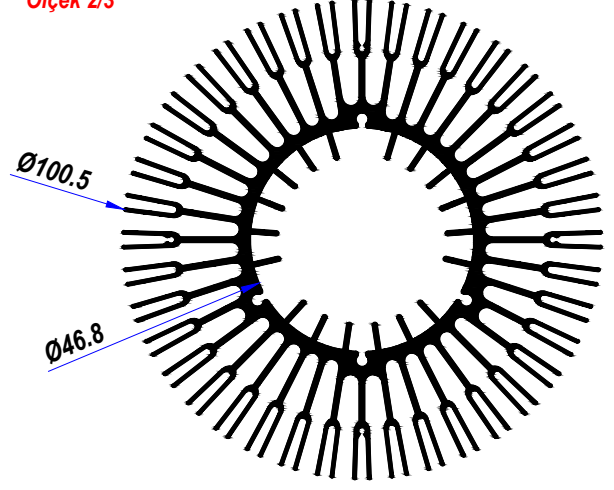

AYS - 105

Ø 105 mm Alm. Sğt. Prf.
Ölçek 1/2

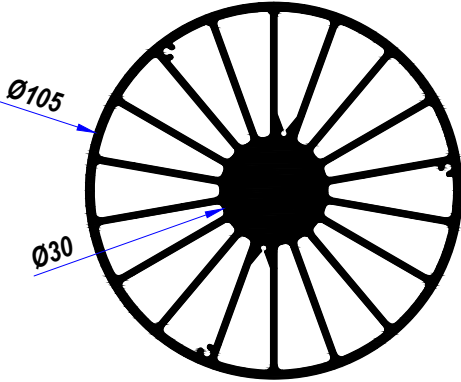

AYS - 110

Ø 110 mm Alm. Sğt. Prf.
Ölçek 1/2

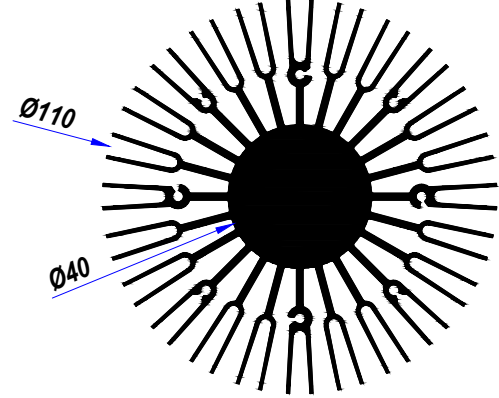

AYS - 115

Ø 115 mm Alm. Sğt. Prf.
Ölçek 1/2

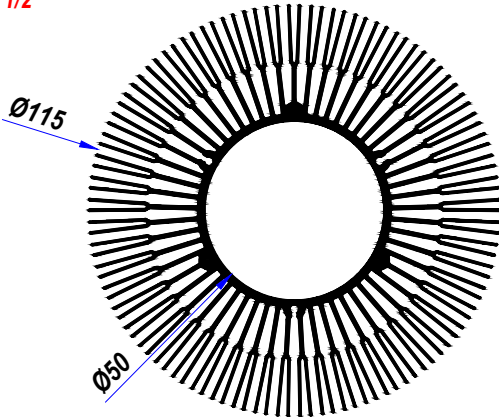

AYS - 120

Ø 120 mm Alm. Sğt. Prf.
Ölçek 1/2

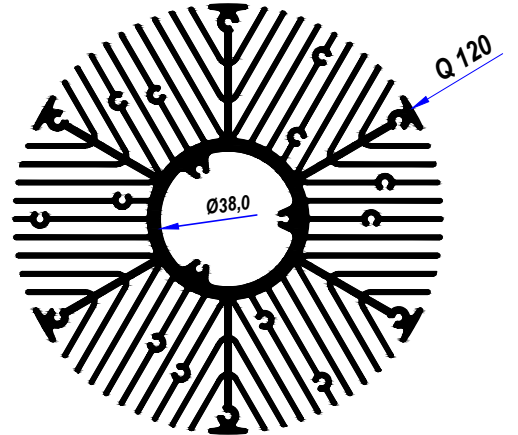

İstenilen ölçülerde kesim yapılır - Renkli eloksal kaplama yapılır
All cutting dimensions and surface coatings can be done according to requirements.

AYS - 121

Ø 121 mm Alm. Sğt. Prf.
Ölçek 1/2

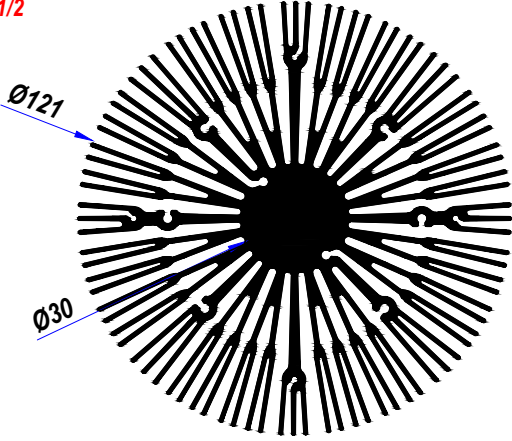

AYS - 125

Ø 125 mm Alm. Sğt. Prf.
Ölçek 1/2

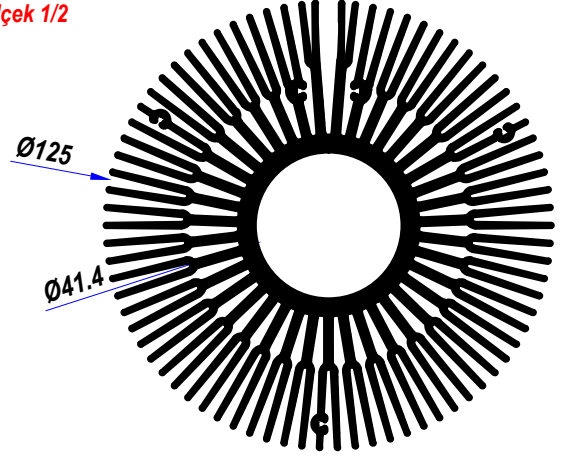

AYS - 130

Ø 130 mm Alm. Sğt. Prf.
Ölçek 1/2

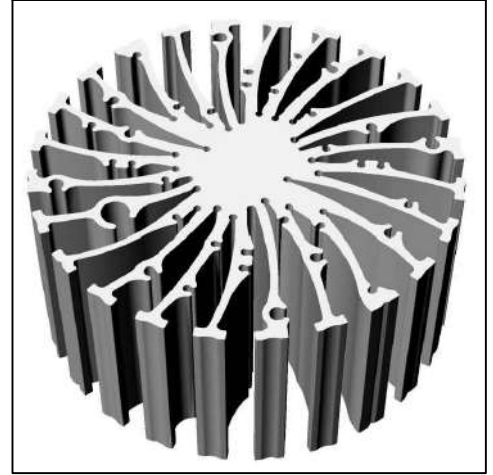
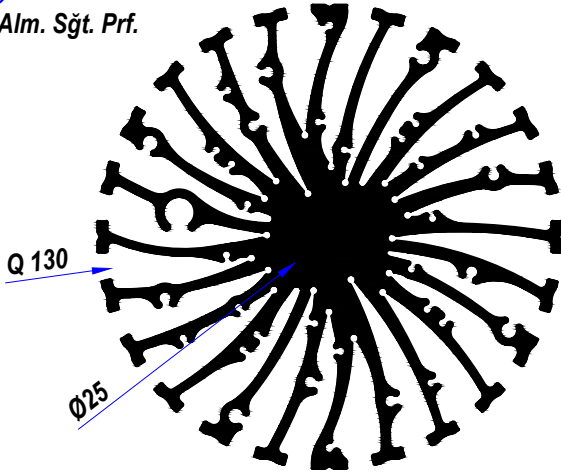

AYS - 134

Ø 134,6 mm Alm. Sğt. Prf.
Ölçek 1/2

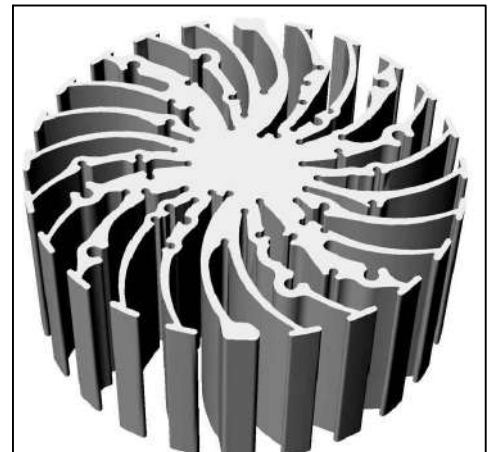
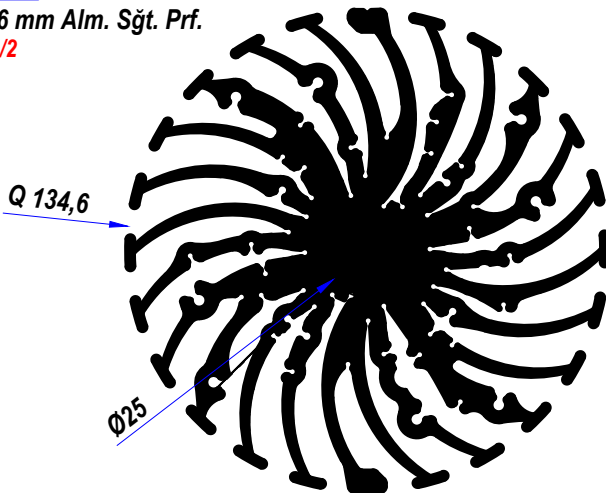

İstenilen ölçülerde kesim yapılır - Renkli eloksal kaplama yapılır
All cutting dimensions and surface coatings can be done according to requirements.

AYS - 138

Ø 138 mm Alm. Sğt. Prf.
Ölçek 1/2

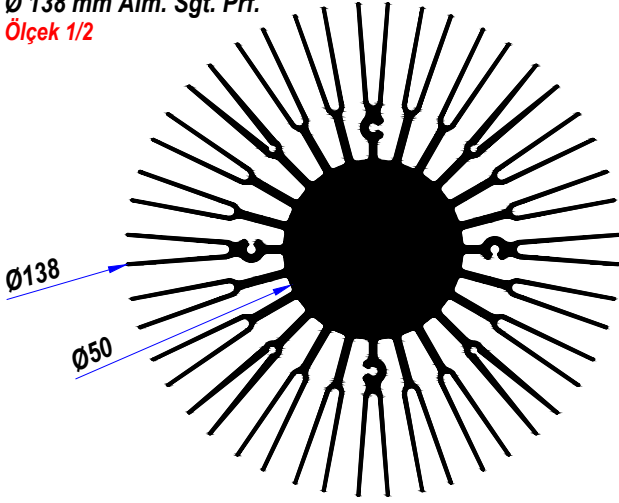

AYS - 140

Ø 140 mm Alm. Sğt. Prf.
Ölçek 1/2

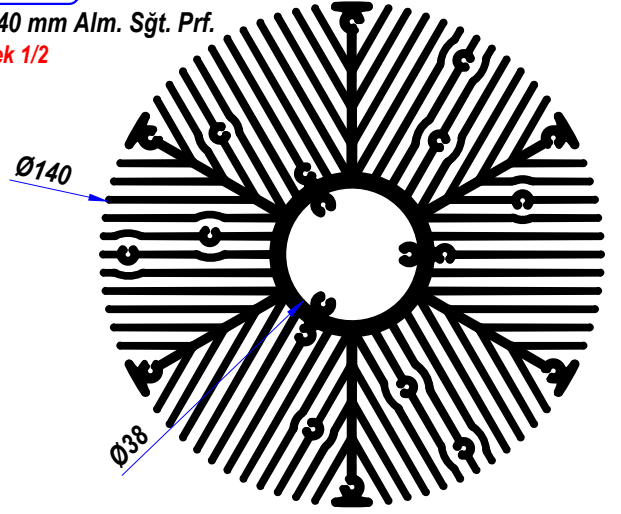

AYS - 150

Ø 150 mm Alm. Sğt. Prf.
Ölçek 1/2

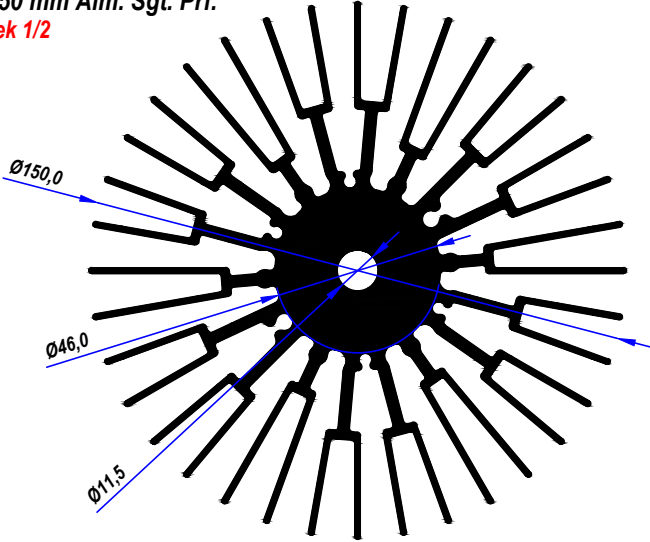

AYS-150 A

Ø 150 mm Alm. Sğt. Prf.
Ölçek 1/2

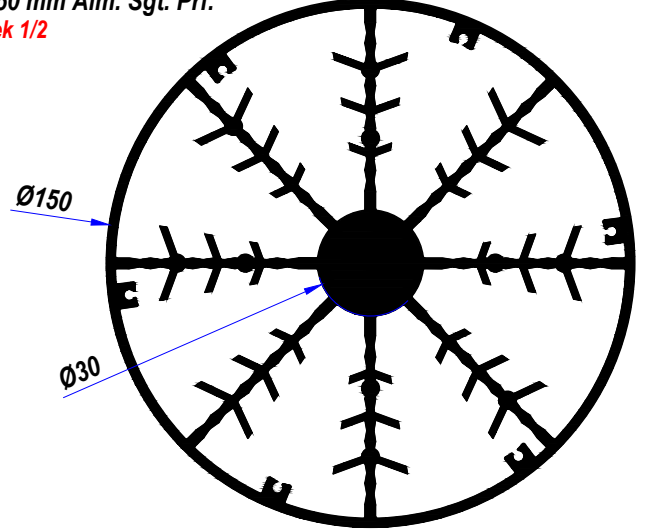

AYS - 160

Ø 160 mm
Alm. Sğt. Prf.
Ölçek 1/2

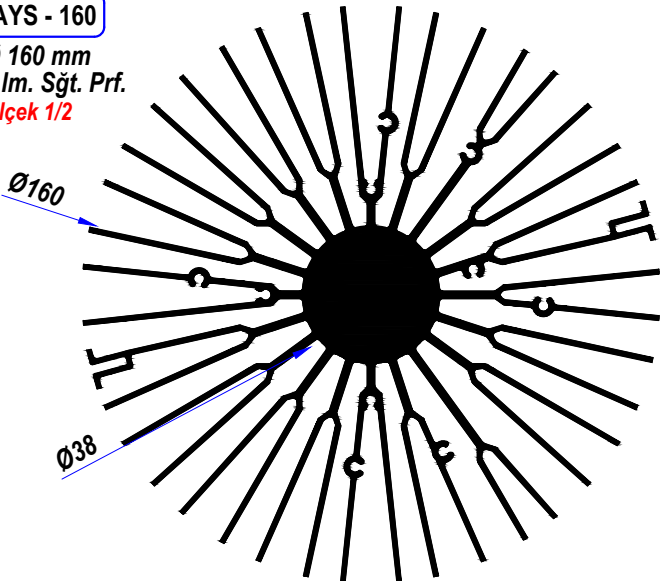

AYS - 170

Ø 170,2 mm
Alm. Sğt. Prf.
Ölçek 1/2

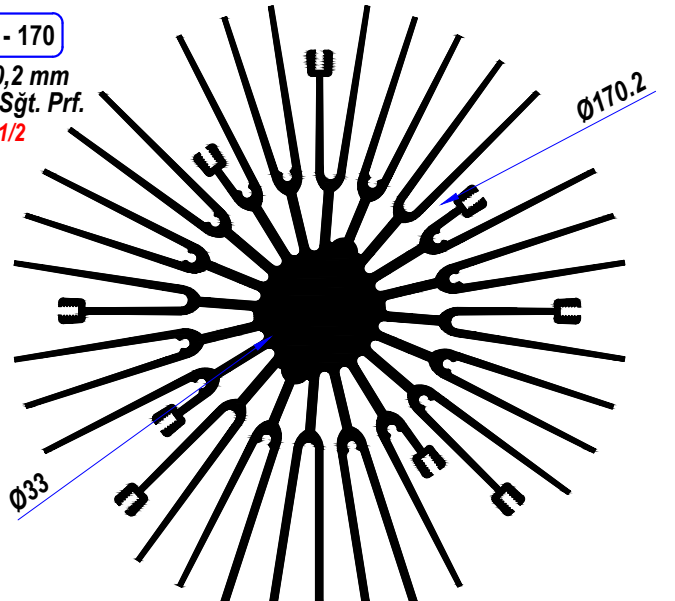

İstenilen ölçülerde kesim yapılır - Renkli eloksal kaplama yapılır
All cutting dimensions and surface coatings can be done according to requirements.

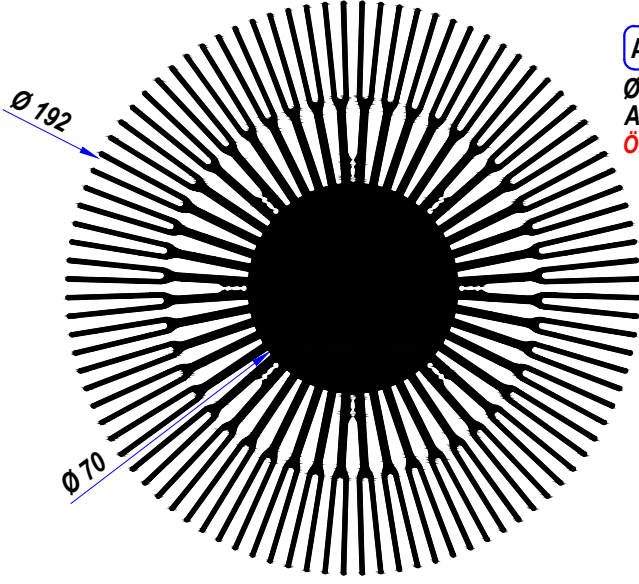

AYS - 192

Ø 192 mm
Alm. Sğt. Prf.
Ölçek 1/2

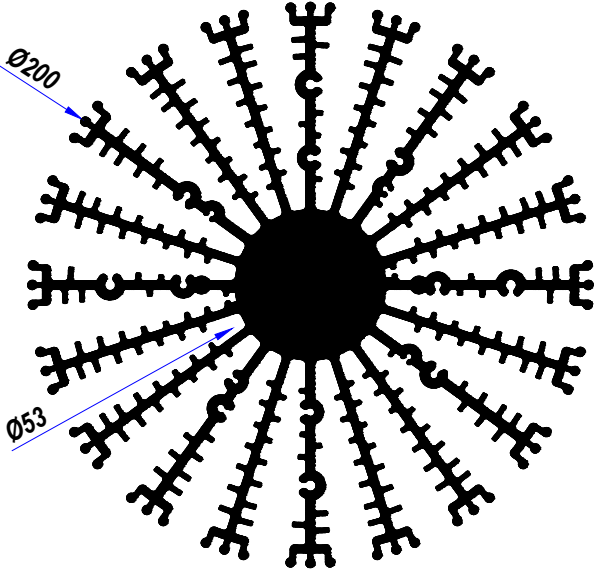
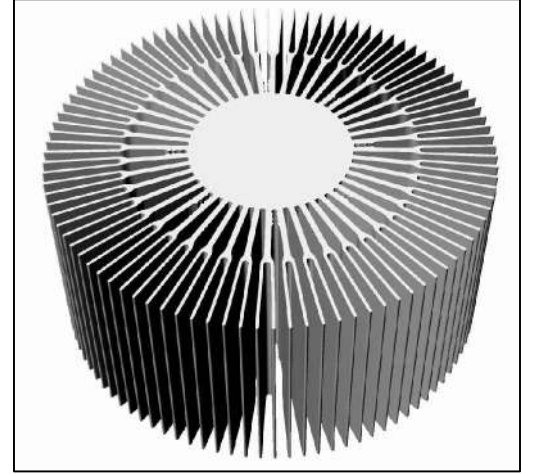

AYS - 200

Ø 200 mm
Alm. Sğt. Prf.
Ölçek 1/2

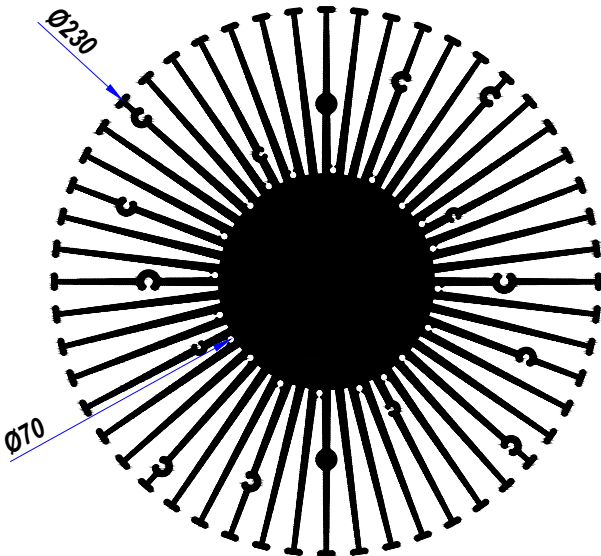
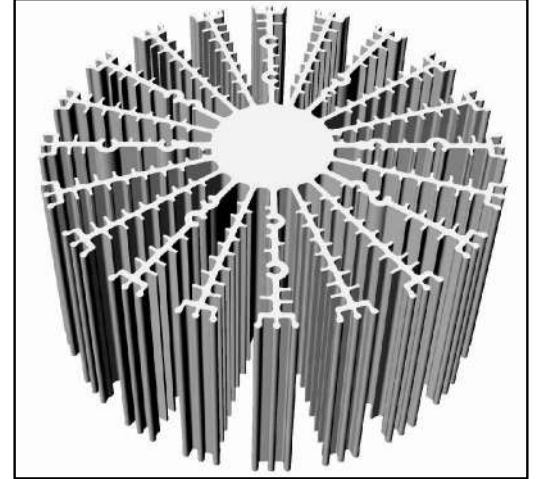

AYS - 230

Ø 230 mm
Alm. Sğt. Prf.
Ölçek 1/2



İstenilen ölçülerde kesim yapılır - Renkli eloksallı kaplama yapılır
All cutting dimensions and surface coatings can be done according to requirements.

Q 24 Alu. Heatsink Prf.

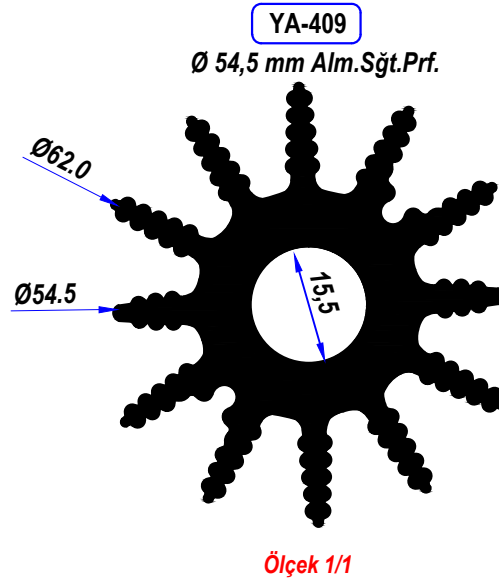
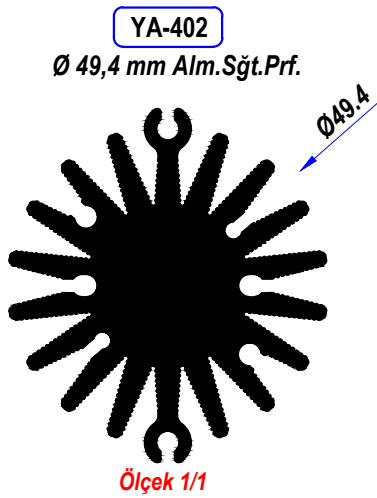
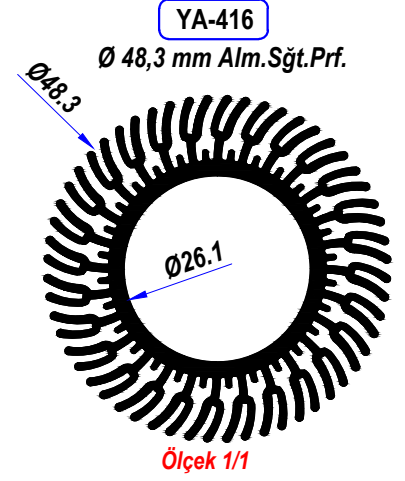
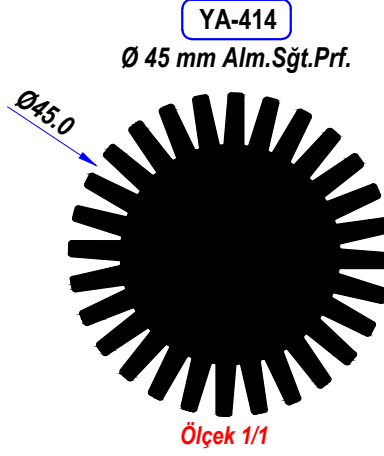
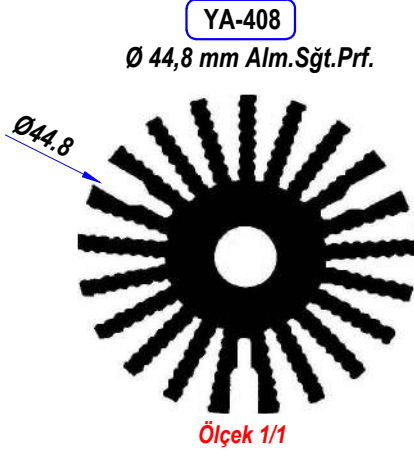
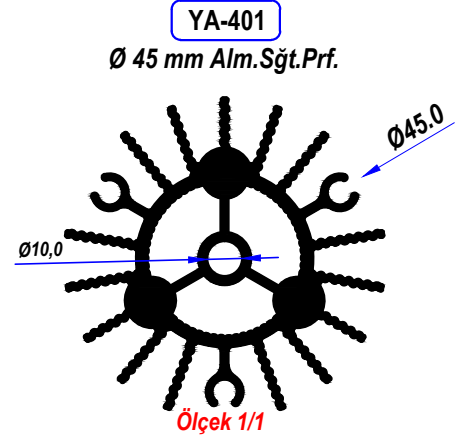
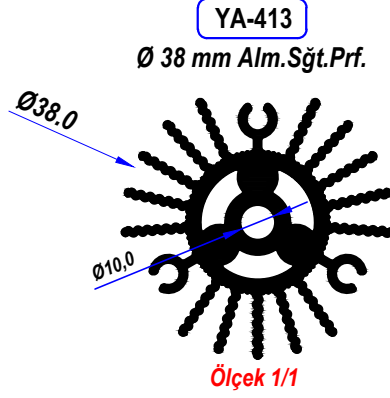
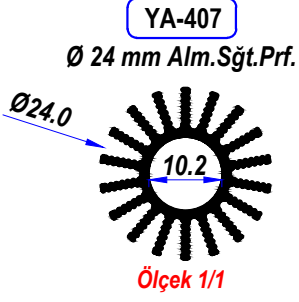

İstenilen ölçülerde kesim yapılır - Renkli eloksal kaplama yapılır
All cutting dimensions and surface coatings can be done according to requirements.

YA-415

Ø 63,6 mm Alm.Sğt.Prf.
ÖLÇEK 2/3

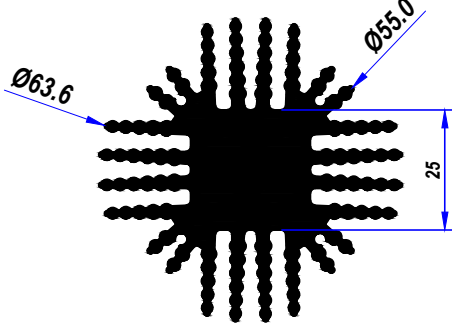

YA-417

Ø 65 mm Alm.Sğt.Prf.
ÖLÇEK 3/4

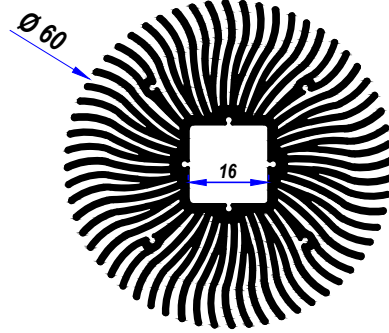

YA-410

Ø 80 mm Alm.Sğt.Prf.
ÖLÇEK 3/4

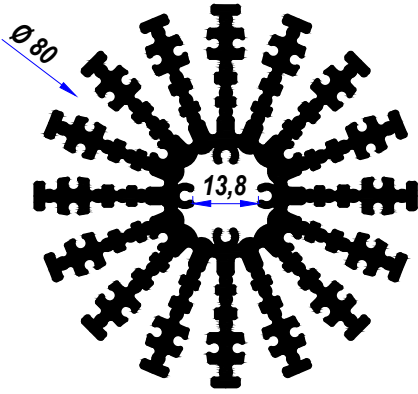

YA-410 F

Q 80 - Alu Flange



ölçeksiz

YA-418

Ø 90 mm Alm.Sğt.Prf.
ÖLÇEK 3/4

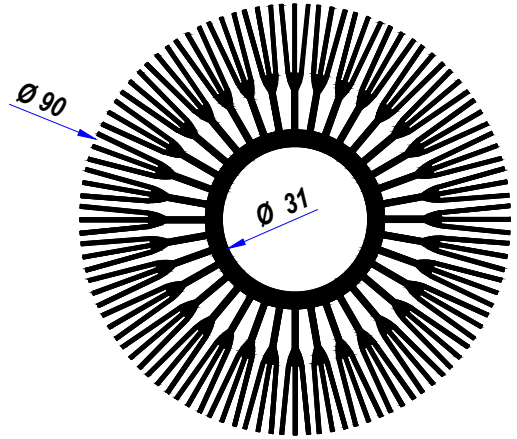

YA-418 A

Ø 90 mm Alm.Sğt.Prf.
ÖLÇEK 3/4

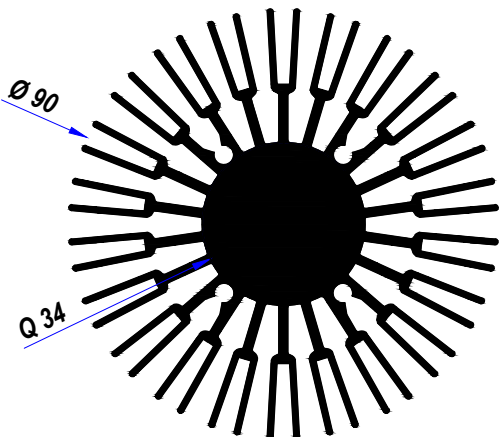

YA-418 F

Q 90 - Alu Flange



ölçeksiz

YENİ

YA-418 B

Ø 47,2 mm Alm.Sğt.Prf.
ÖLÇEK 3/4

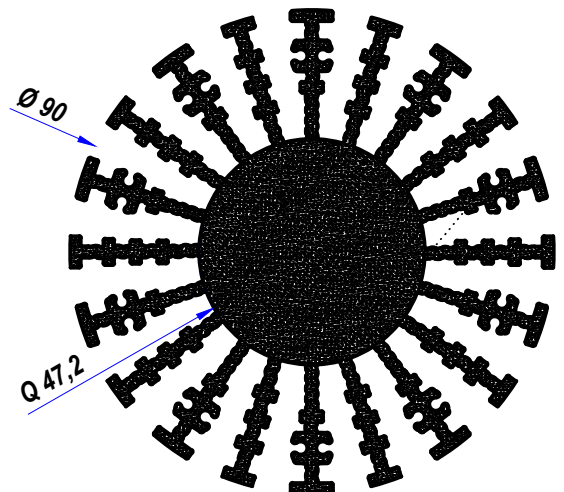

İstenilen ölçülerde kesim yapılır - Renkli eloksal kaplama yapılır
All cutting dimensions and surface coatings can be done according to requirements.

YA-419

Ø 100 mm Alm.Sğt.Prf.
Ölçek 1/2

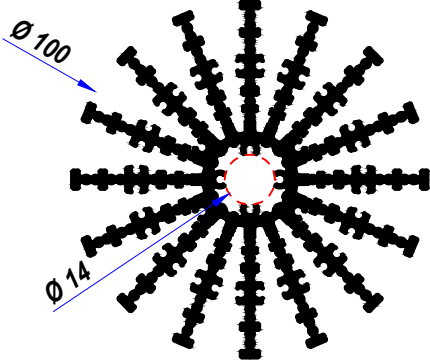

YA-419 F

Q 100 - Alu Flange



ölçeksiz

YA-419 A

Ø 100 mm Alm.Sğt.Prf.
Ölçek 1/2

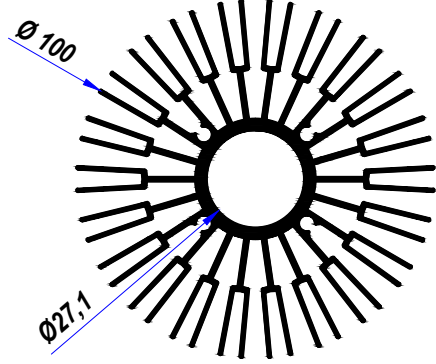

YA-420

Ø 120 mm Alm.Sğt.Prf.
Ölçek 1/2

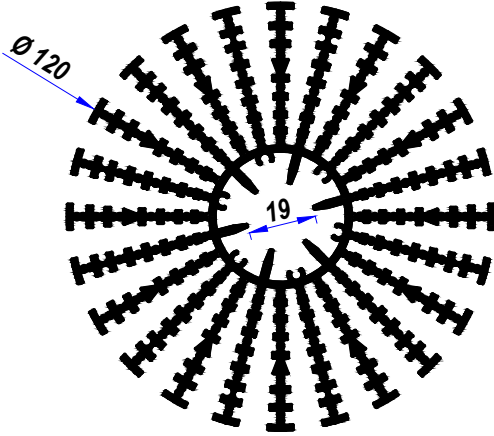

YA-420 F

Q 120 - Alu Flange



ölçeksiz

YA-420 A

Ø 120 mm Alm.Sğt.Prf.
Ölçek 1/2

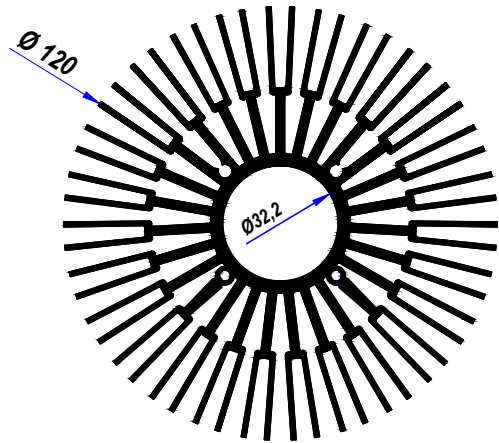

YA-420 B

Ø 120 mm Alm.Sğt.Prf.
Ölçek 1/2

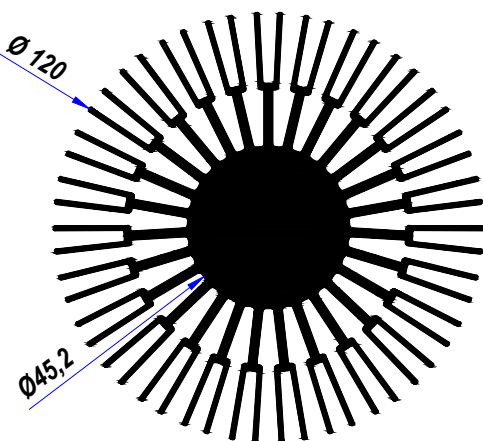

YA-420 C

Ø 120 mm Alm.Sğt.Prf.
Ölçek 1/2

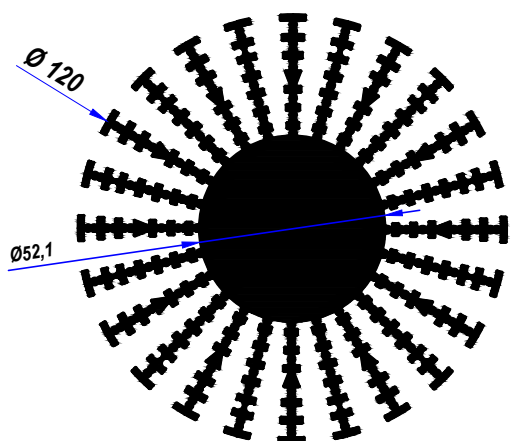

İstenilen ölçülerde kesim yapılır - Renkli eloksal kaplama yapılır
All cutting dimensions and surface coatings can be done according to requirements.

YA-411

Ø 140 mm Alm.Sğt.Prf.
Ölçek 1/2

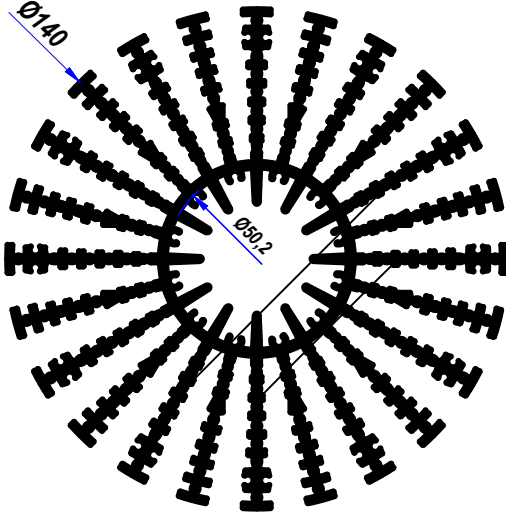

YA-411 F

Q 140 - Alu Flange



ölçeksiz

YA-411 A

Ø 140 mm Alm.Sğt.Prf.
Ölçek 1/2

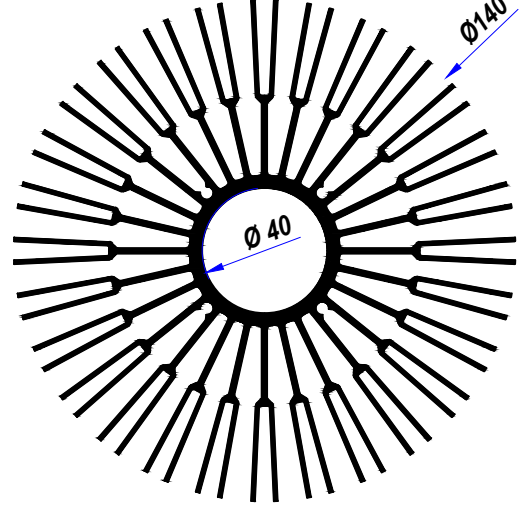

YA-412

Ø 160 mm Alm.Sğt.Prf.
Ölçek 1/2

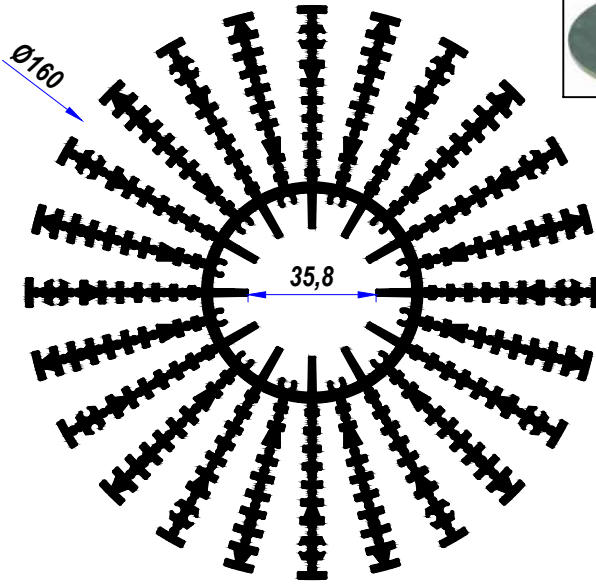

YA-412 F

Q 160 - Alu Flange

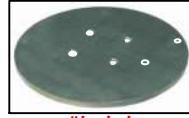

ölçeksiz

YA-412 A

Ø 160 mm Alm.Sğt.Prf.
Ölçek 1/2

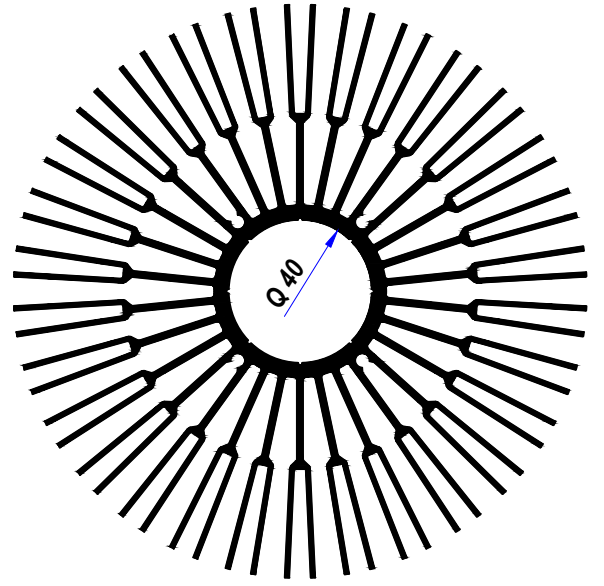

YA-423

Ø 50 mm Alm.Sğt.Prf.
Ölçek 1/1

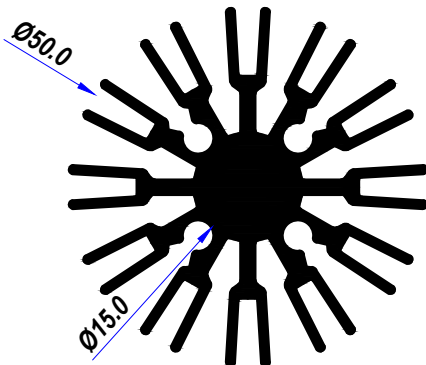

YA-424

Ø 70 mm Alm.Sğt.Prf.
Ölçek 3/4

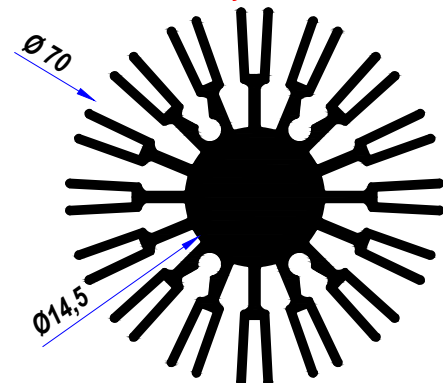

İstenilen ölçülerde kesim yapılır - Renkli eloksal kaplama yapılır
All cutting dimensions and surface coatings can be done according to requirements.

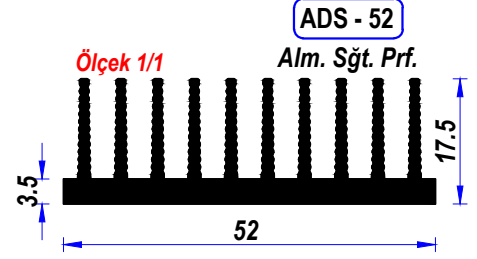
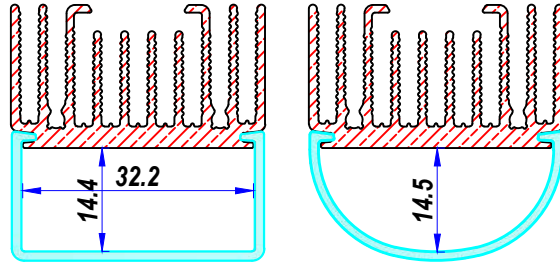
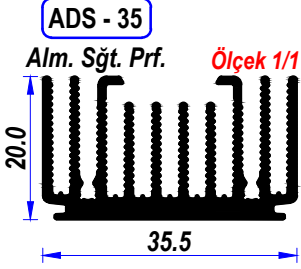

YA-253 M Mini Ayak Seti

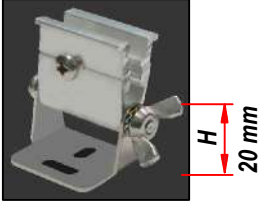

YA-204 C PC. Difüzör **YA-204 B**

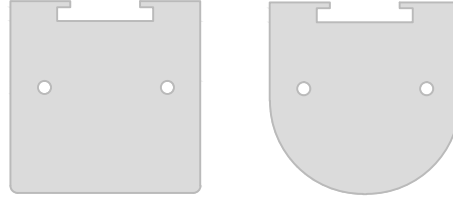

ADS-35 T1 **ADS-35 T2**

Alm. Kenar Tapa

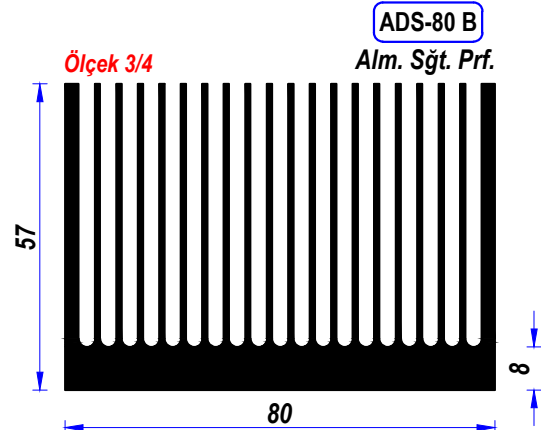
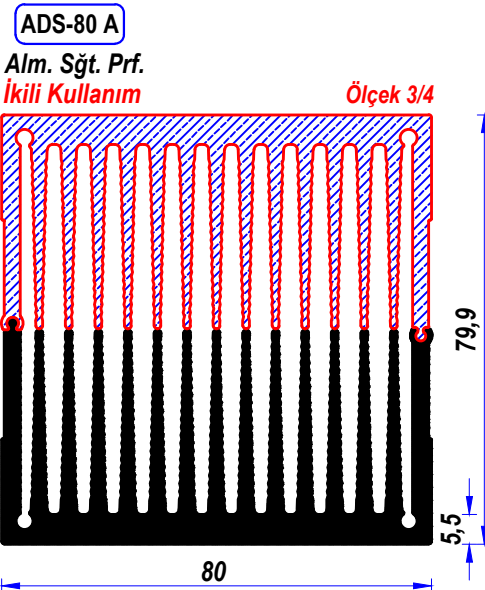
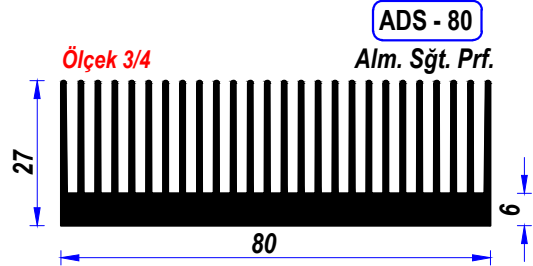
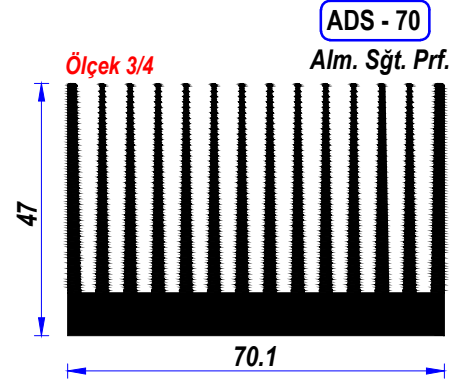
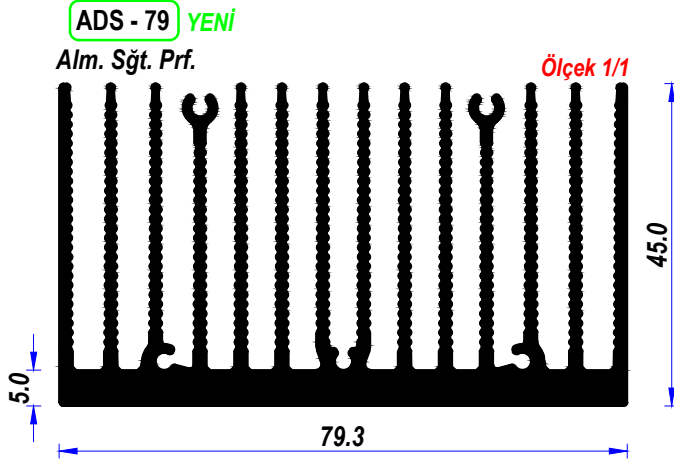
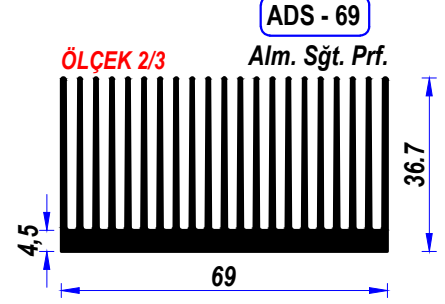

İstenilen ölçülerde kesim yapılır - Renkli eloksal kaplama yapılır
All cutting dimensions and surface coatings can be done according to requirements.

ADS - 92

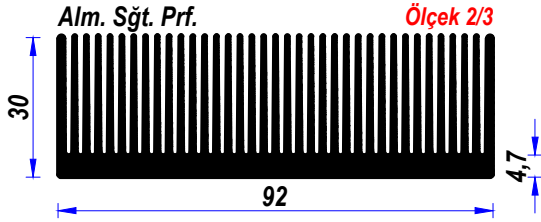

ADS-101

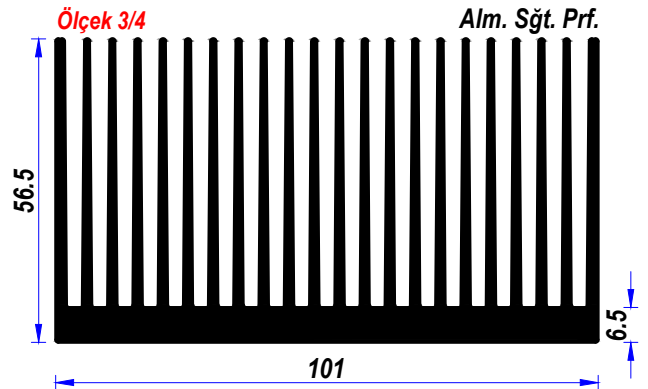

ADS - 95

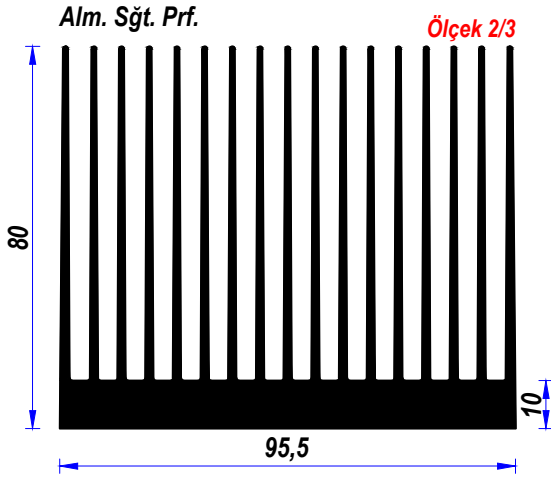

ADS - 104

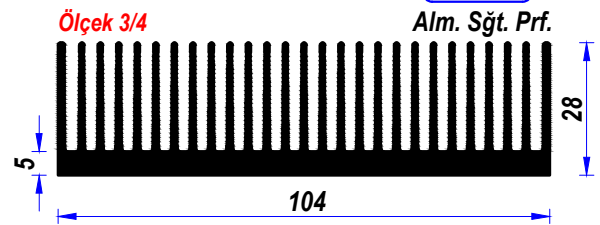

ADS - 114

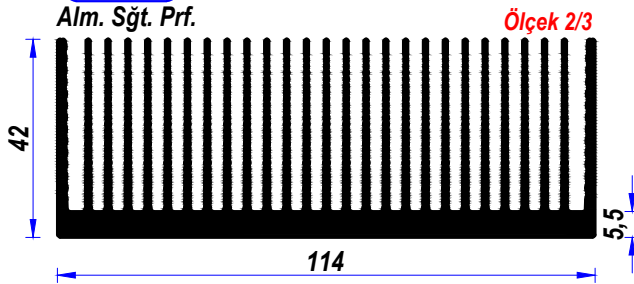

ADS - 117

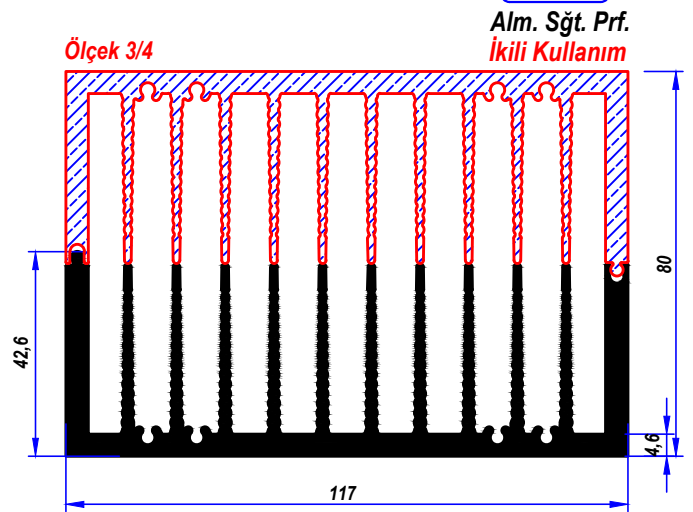

ADS - 115

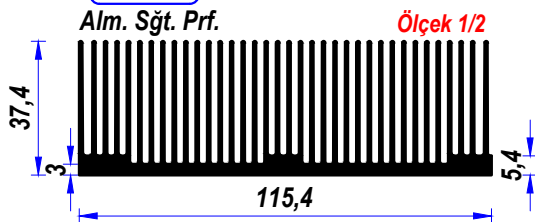

ADS - 120

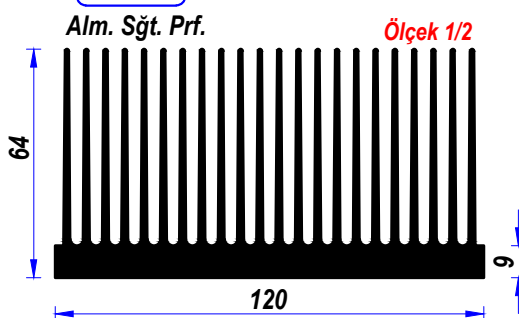

ADS - 122

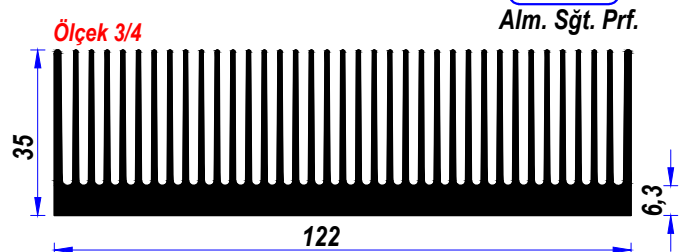

İstenilen ölçülerde kesim yapılır - Renkli eloksal kaplama yapılır
All cutting dimensions and surface coatings can be done according to requirements.

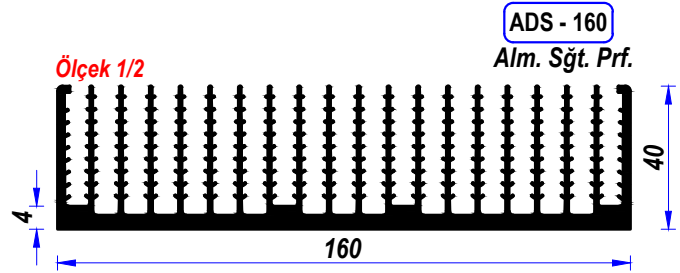
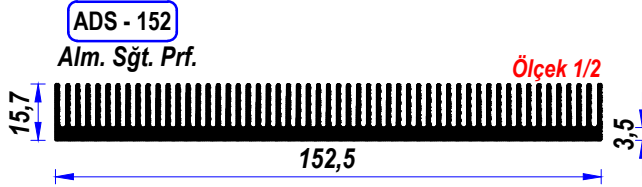
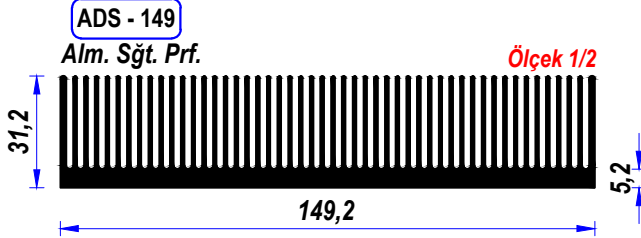
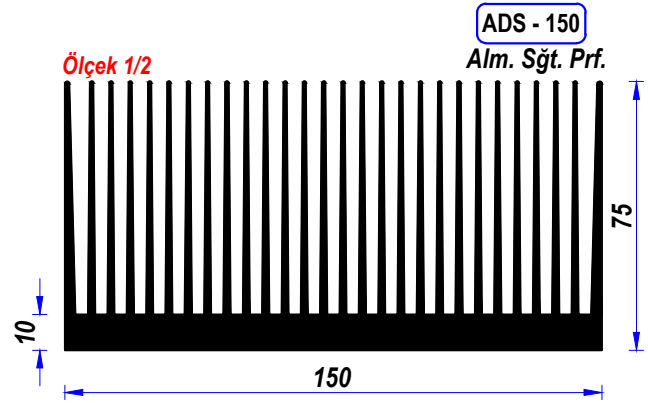
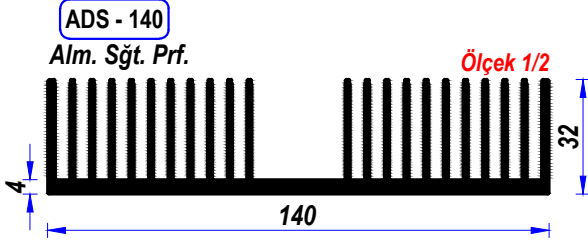
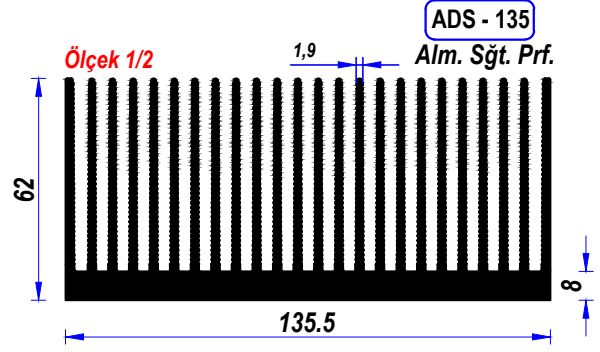
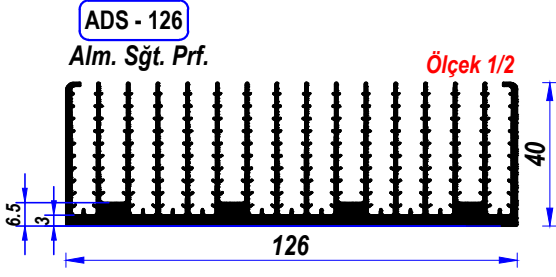

YA-1310 A PC. Cam; Kanopi kahasına, Alm.Profil YA-173 A; modül lense,
Sokak Arm. ve Prj. Kasalarına uygun Alm. Profil

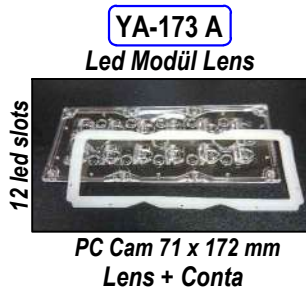
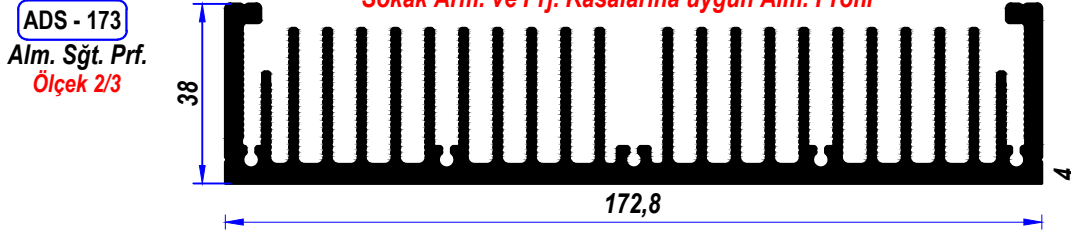

YA-173 Alm. Prf.

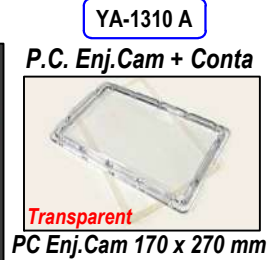

İstenilen ölçülerde kesim yapılır - Renkli eloksallı kaplama yapılır
All cutting dimensions and surface coatings can be done according to requirements.

ADS - 178

Alm. Sğt. Prf.
Ölçek 1/2

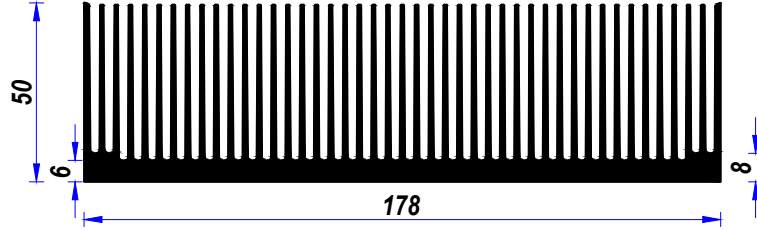

ADS - 180

Alm. Sğt. Prf.
Ölçek 1/2

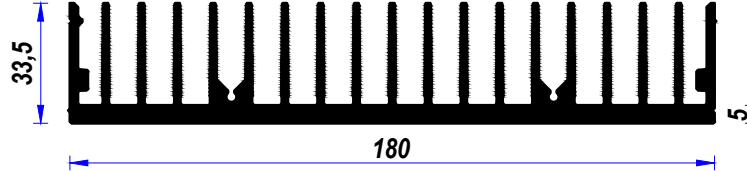

YA-1310 A

P.C. Enj.Cam+Conta



PC Enj.Cam 170 x 270 mm

ADS - 190

Alm. Sğt. Prf.
Ölçek 1/2

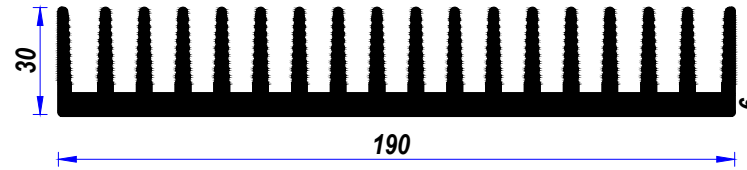

YA-1310 A

P.C. Enj.Cam+Conta



PC Enj.Cam 170 x 270 mm

ADS - 200

Alm. Sğt. Prf.
Ölçek 1/2

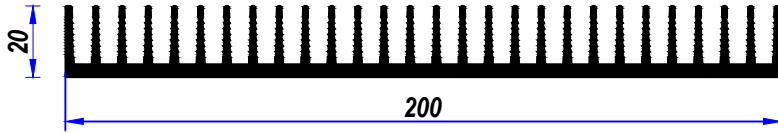

ADS - 209

Alm. Sğt. Prf.
Ölçek 1/2

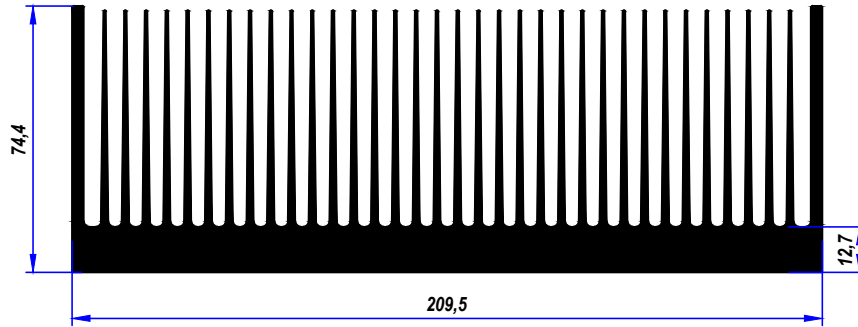

ADS - 210

Alm. Sğt. Prf.
Ölçek 1/2

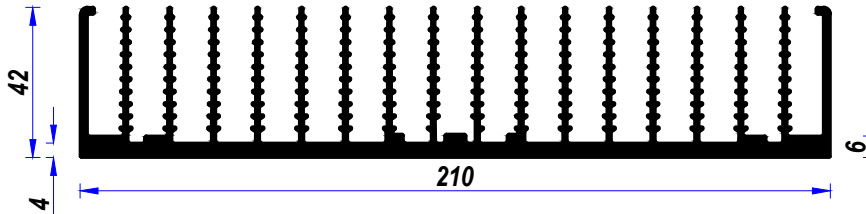

ADS - 210 A

Alm. Sğt. Prf.
Ölçek 1/2

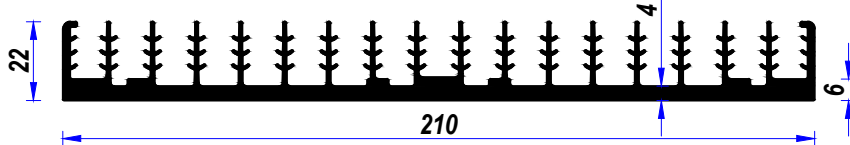

ADS - 223

Alm. Sğt. Prf.
Ölçek 1/2

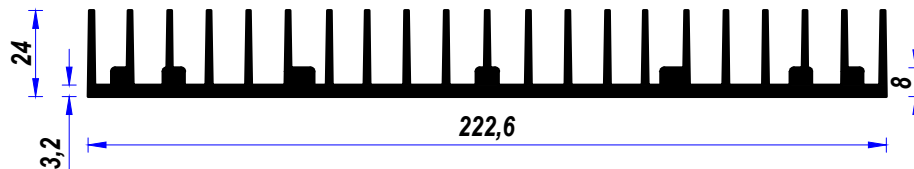

İstenilen ölçülerde kesim yapılır - Renkli eloksal kaplama yapılır
All cutting dimensions and surface coatings can be done according to requirements.

ADS - 244
Alm. Sğt. Prf.
Ölçek 1/2

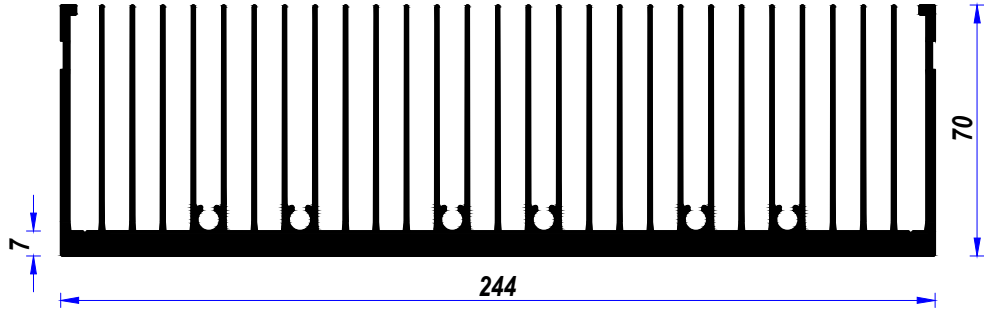

ADS - 250
Alm. Sğt. Prf.
Ölçek 1/2

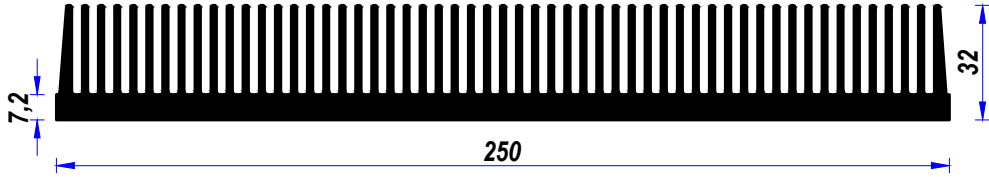

ADS - 267
Alm. Sğt. Prf.
Ölçek 1/2

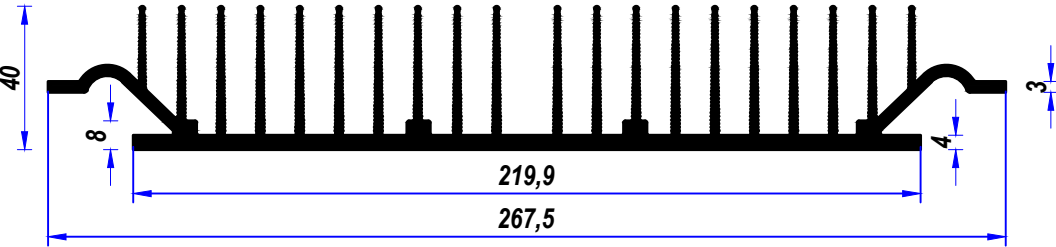

Suitable for canopy frame, alu.prf. and PC Diffuser

ADS - 278
Alm. Sğt. Prf.
Ölçek 1/2

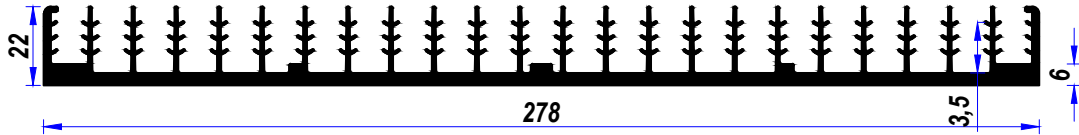

Economic Alu. Heatsink Prf.

YA-1311 A Pc



YA-278 Alu.prf.

100 Watt

YA-1311 A

P.C. Enj. Dif + Gasket



Standard Width: 32 cm

DIF ; 270 x 370 mm

ADS - 280
Alm. Sğt. Prf.
Ölçek 1/2

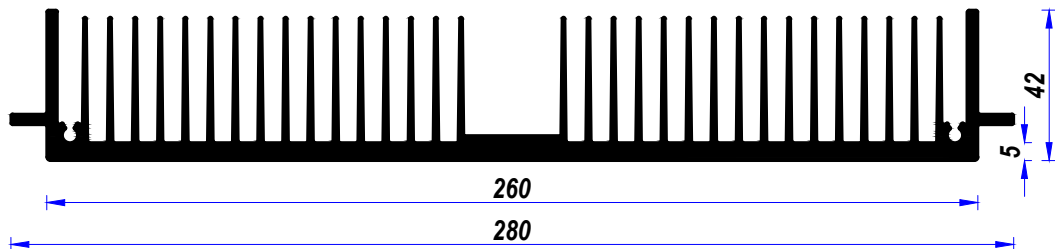

İstenilen ölçülerde kesim yapılır - Renkli eloksal kaplama yapılır
All cutting dimensions and surface coatings can be done according to requirements.

YENİ

ADS - 292

Alm. Sjt. Prf.
Ölçek 1/3

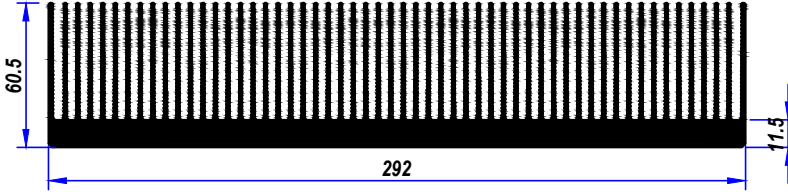

ADS - 296

Alm. Sjt. Prf.
Ölçek 1/3



ADS-296 A

Alm. Sjt. Prf.
Ölçek 1/3

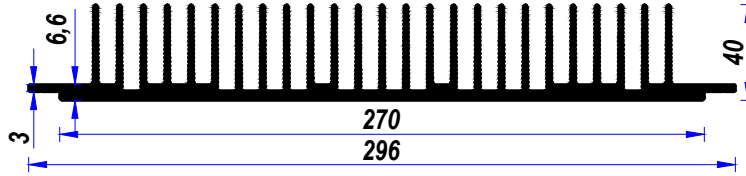

ADS - 298

Alm. Sjt. Prf.
Ölçek 1/3

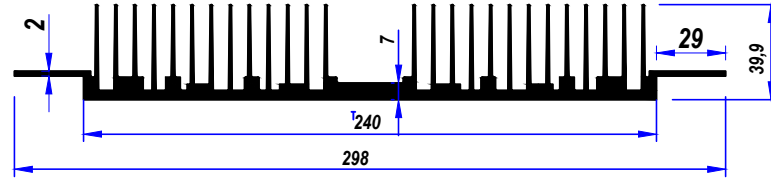

ADS-298 A

Alm. Sjt. Prf.
Ölçek 1/3

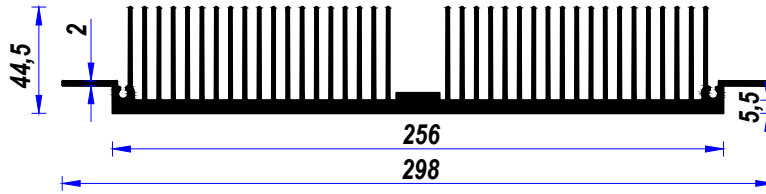

ADS-300 A

Alm. Sjt. Prf.
Ölçek 1/3

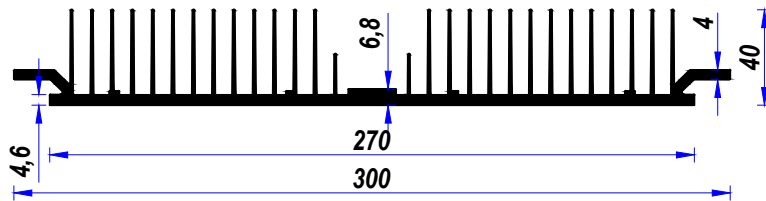

YA-1311 A

PC. Enj. Diffuser + Gasket



Transparent
PC DIFFUSER ; 270 x 370 mm

ADS - 305

Alm. Sjt. Prf.
Ölçek 1/3

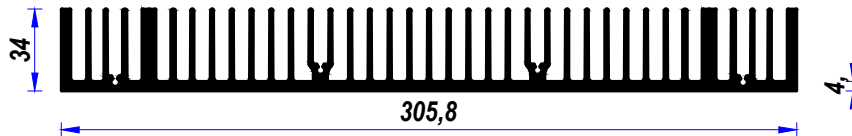

ADS - 307

Alm. Sjt. Prf.
Ölçek 1/3

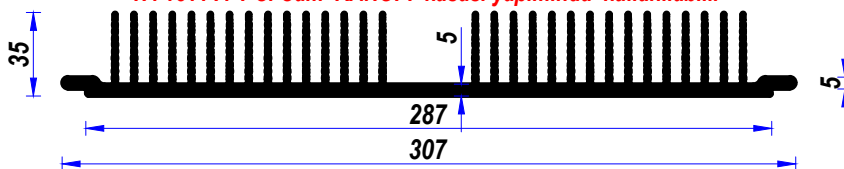

YA-1311 A PC. Cam KANOPI kasası yapımında kullanılabilir

İstenilen ölçülerde kesim yapılır - Renkli eloksal kaplama yapılır
All cutting dimensions and surface coatings can be done according to requirements.

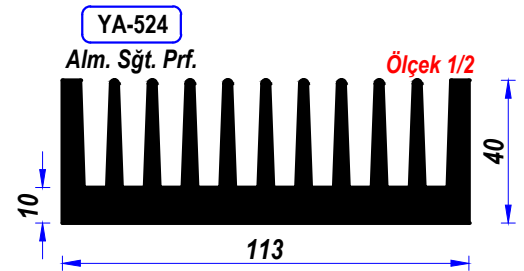
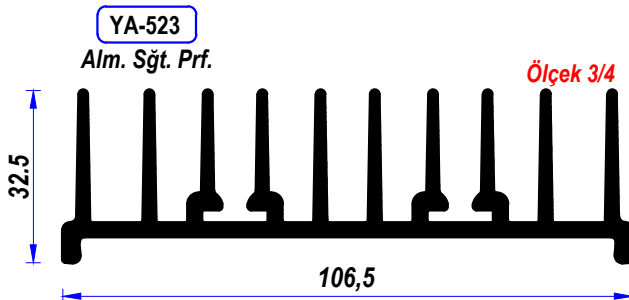
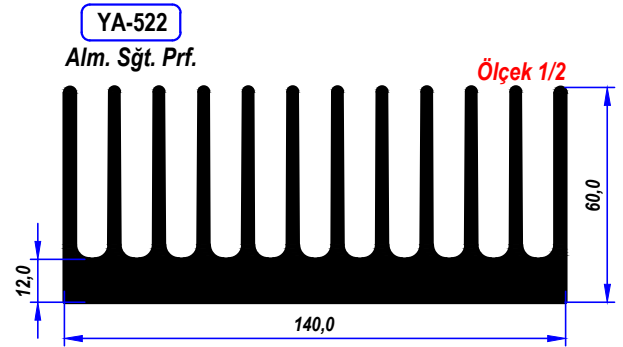
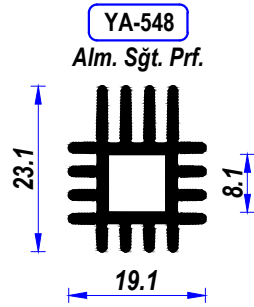
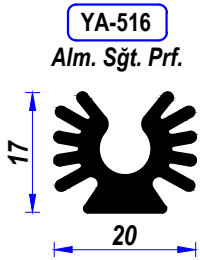
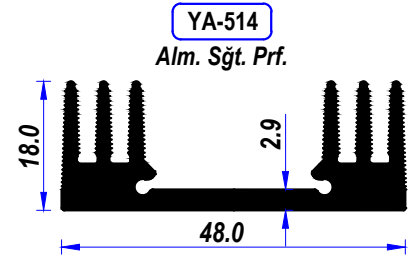
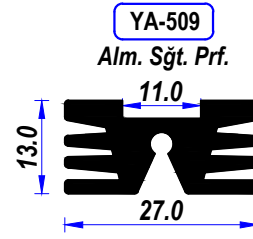
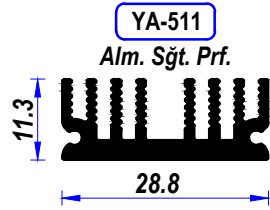
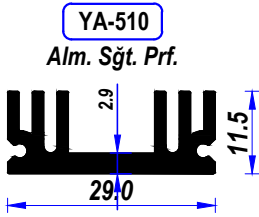
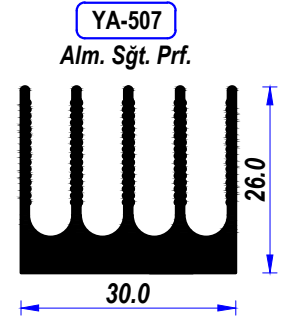
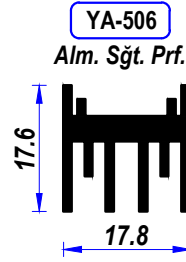
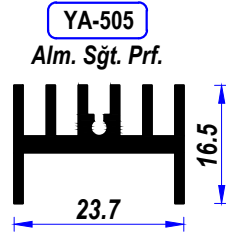
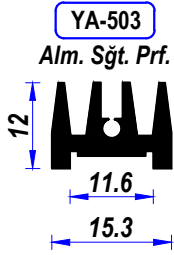
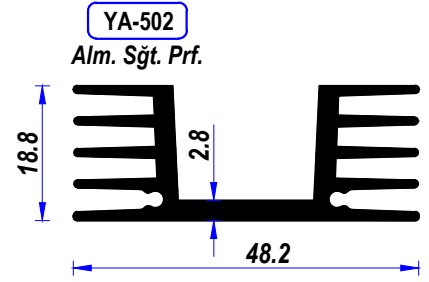
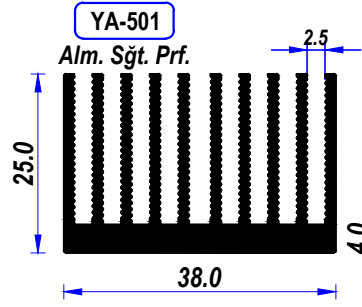
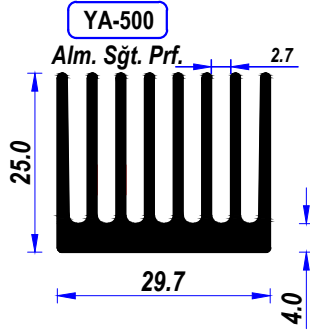

İstenilen ölçülerde kesim yapılır - Renkli eloksallı kaplama yapılır
All cutting dimensions and surface coatings can be done according to requirements.

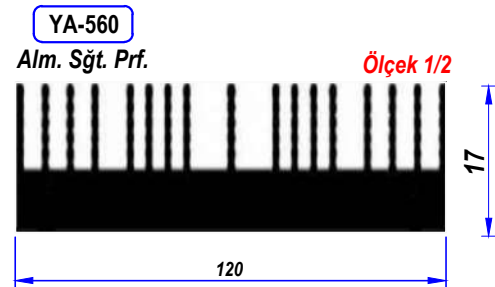
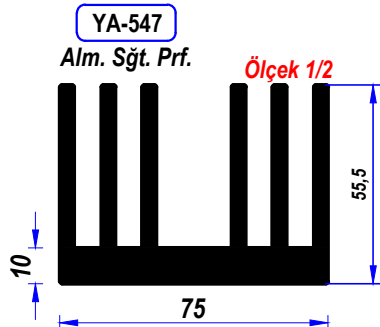
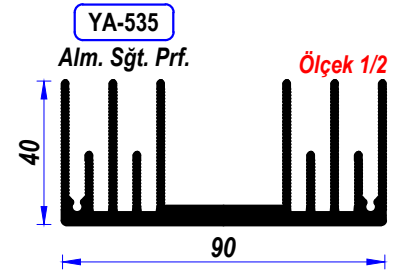
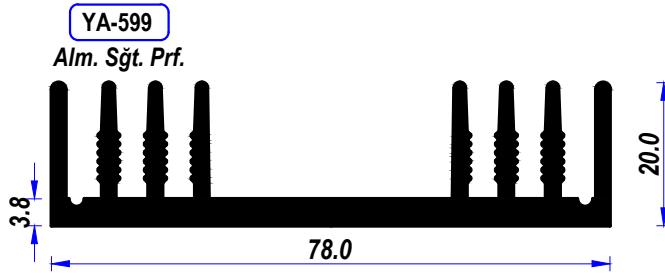
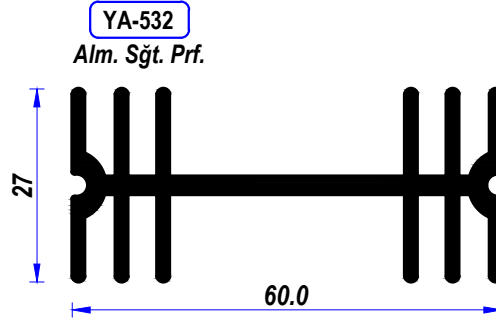
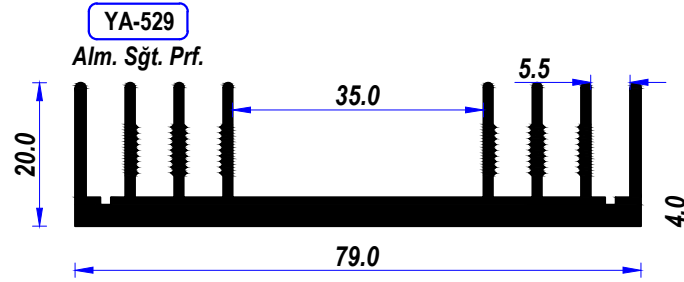
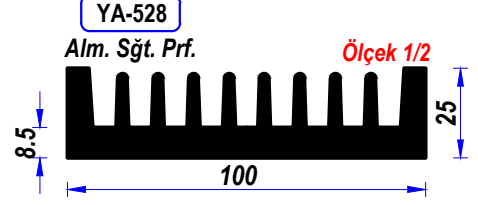
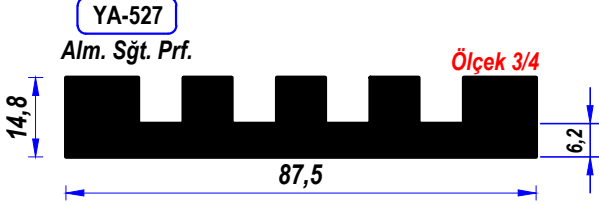
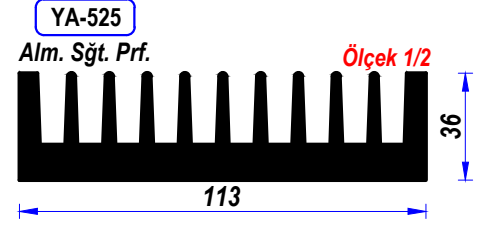
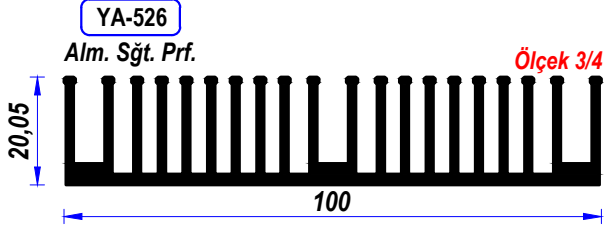

İstenilen ölçülerde kesim yapılır - Renkli eloksall kaplama yapılır
All cutting dimensions and surface coatings can be done according to requirements.

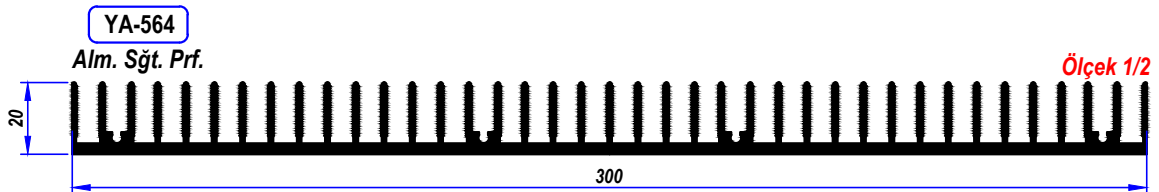
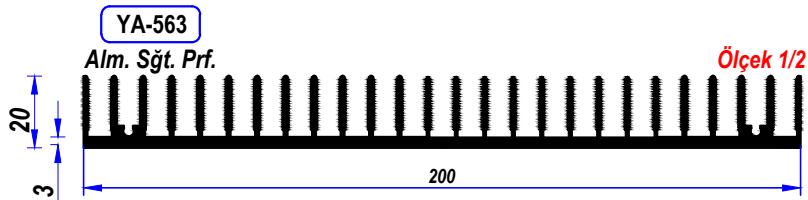
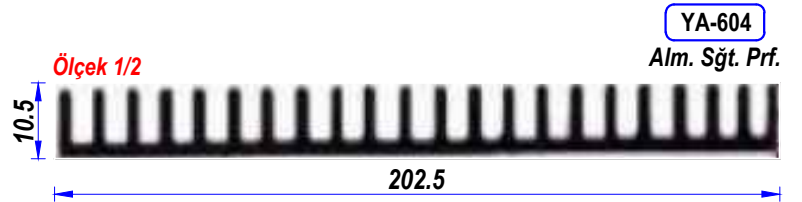
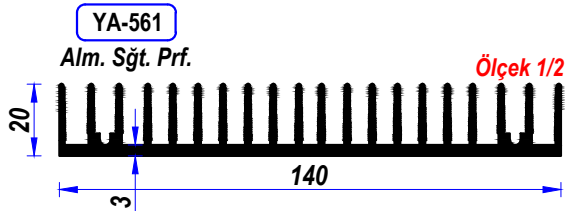
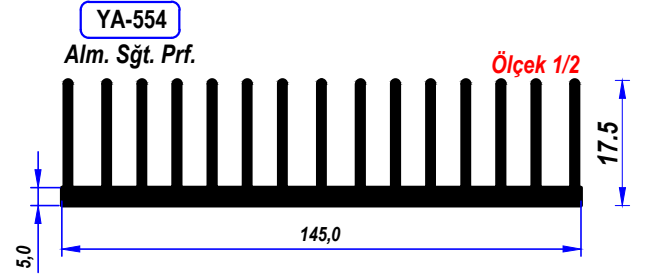
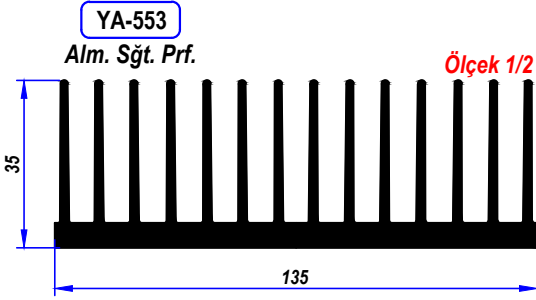
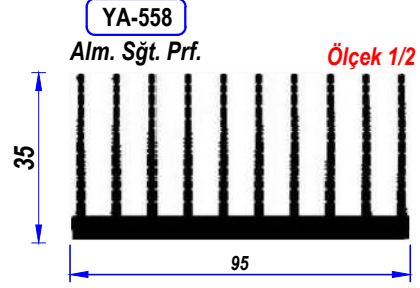
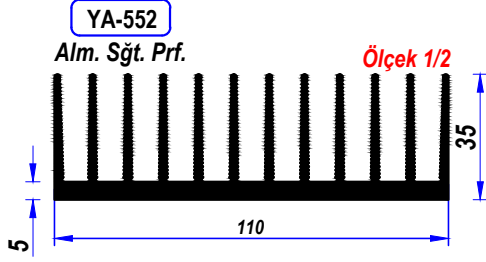
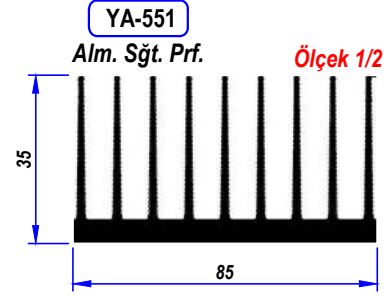
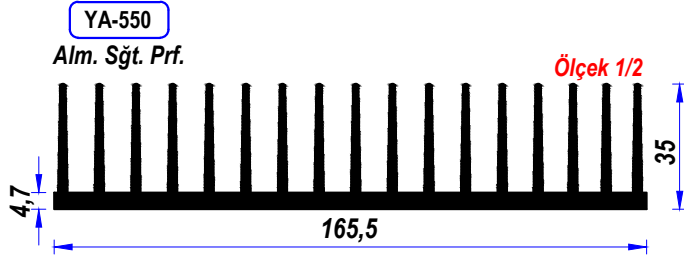

İstenilen ölçülerde kesim yapılır - Renkli eloksal kaplama yapılır
All cutting dimensions and surface coatings can be done according to requirements.

YA-531
Alm. Sğt. Prf.
Ölçek 1/1

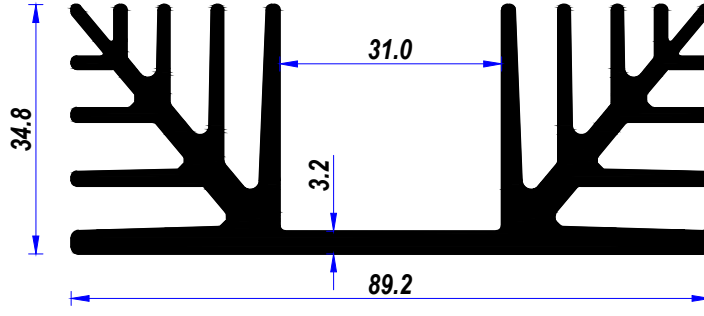

YA-583
Alm. Sğt. Prf.

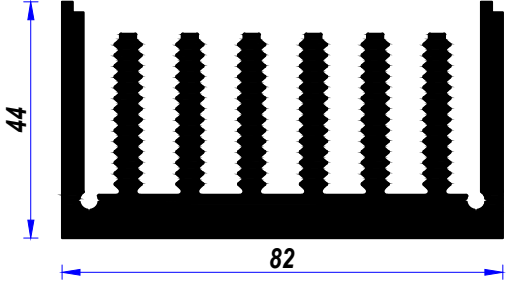

YA-592
Alm. Sğt. Prf.

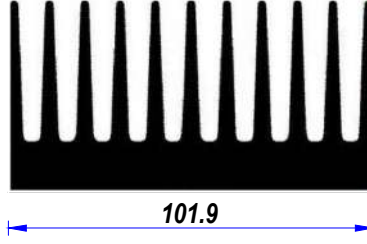

YA-594
Alm. Sğt. Prf.

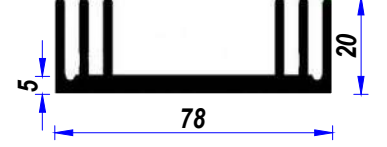

YA-593
Alm. Sğt. Prf.

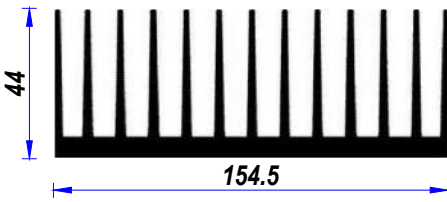

YA-595
Alm. Sğt. Prf.

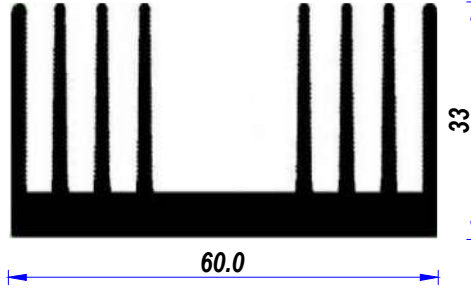

YA-596
Alm. Sğt. Prf.

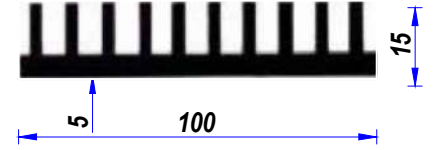

YA-597
Alm. Sğt. Prf.

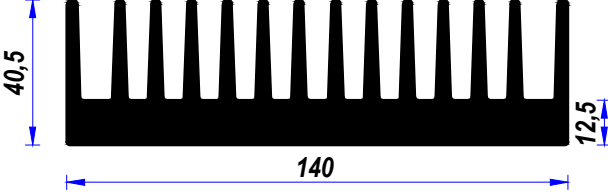

YA-598
Alm. Sğt. Prf.

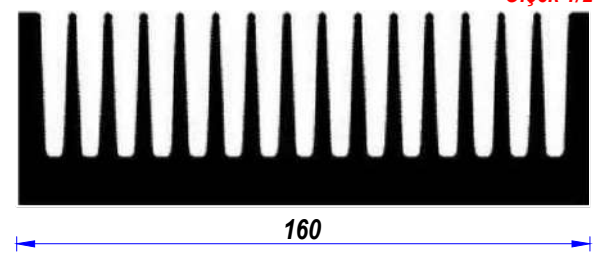

YA-601
Alm. Sğt. Prf.

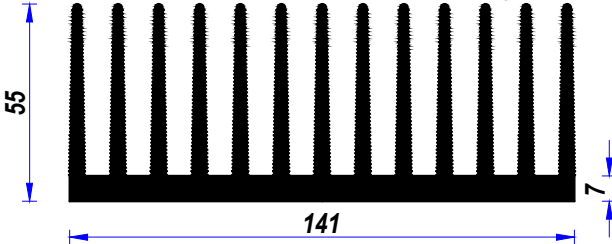

YA-602
Alm. Sğt. Prf.

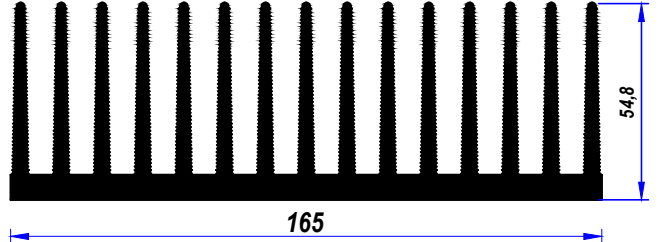

İstenilen ölçülerde kesim yapılır - Renkli eloksal kaplama yapılır
All cutting dimensions and surface coatings can be done according to requirements.

YA-600

Alm. Sğt. Prf.

Ölçek 1/3

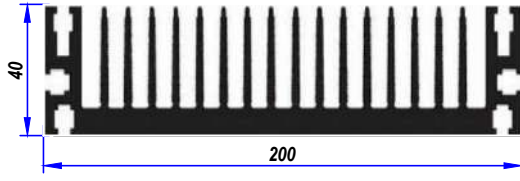

YA-603

Alm. Sğt. Prf.

Ölçek 1/3

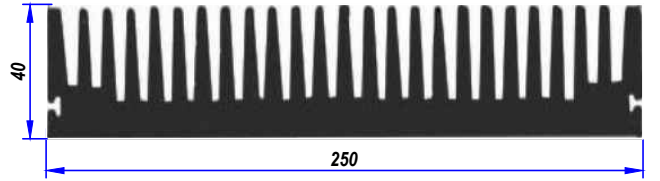

YA-613

Alm. Sğt. Prf.

Ölçek 1/2

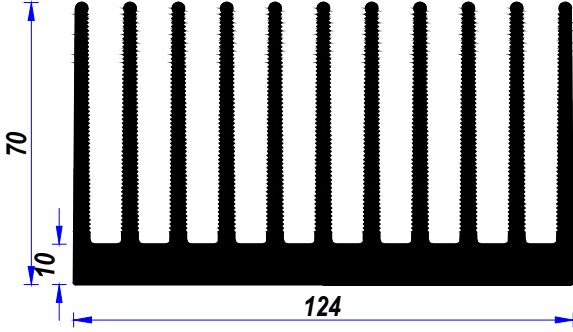

YA-607

Alm. Sğt. Prf.

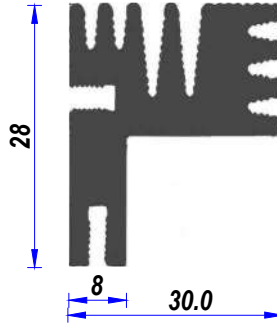

YA-620

Alm. Sğt. Prf.

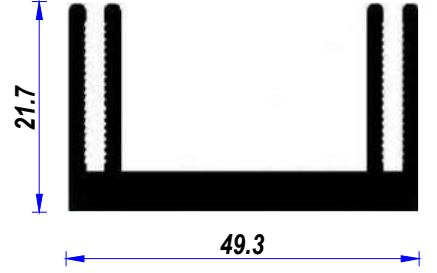

YA-625

Alm. Sğt. Prf.

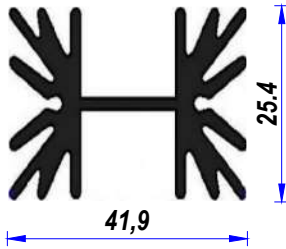

YA-626

Alm. Sğt. Prf.

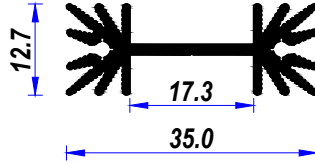

YA-627

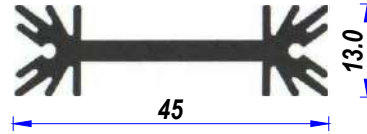

YA-623

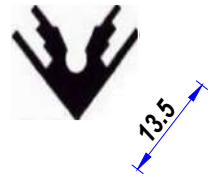

YA-624

Alm. Sğt. Prf.

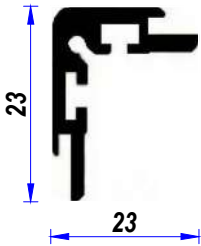

YA-653

Alm. Sğt. Prf.

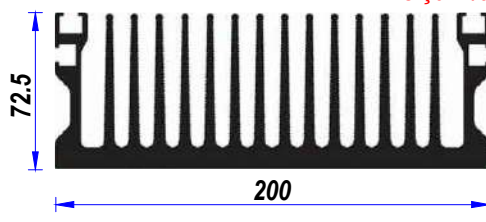

YA-665

Alm. Sğt. Prf.

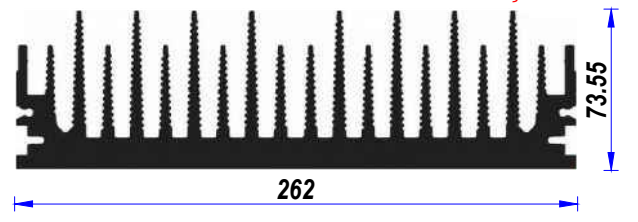

YA-632

Alm. Sğt. Prf.

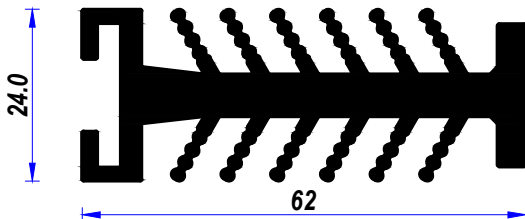

YA-633

Alm. Sğt. Prf.

Ölçek 1/2

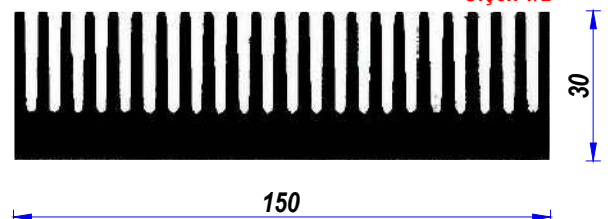

İstenilen ölçülerde kesim yapılır - Renkli eloksal kaplama yapılır
All cutting dimensions and surface coatings can be done according to requirements.

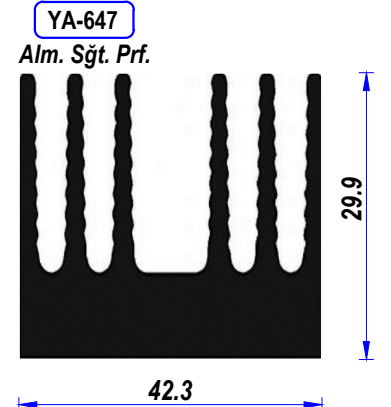
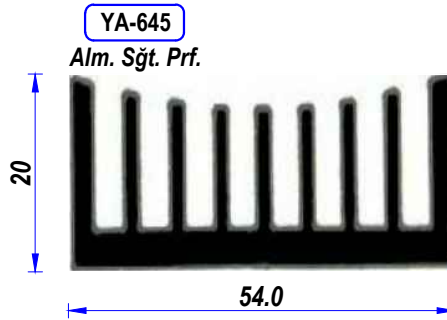
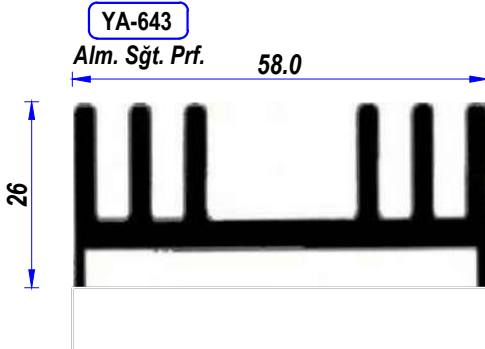
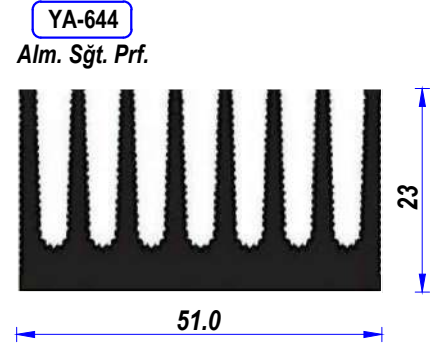
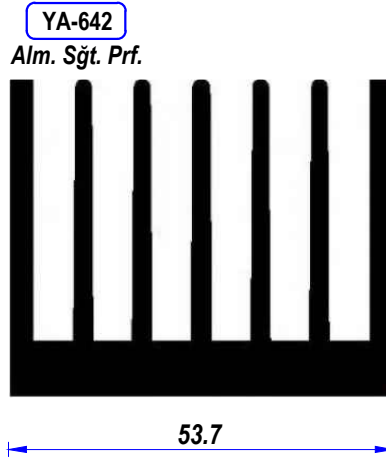
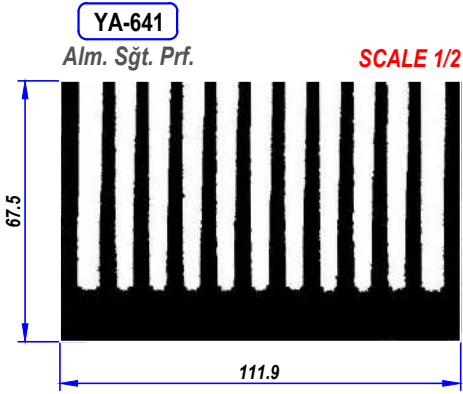
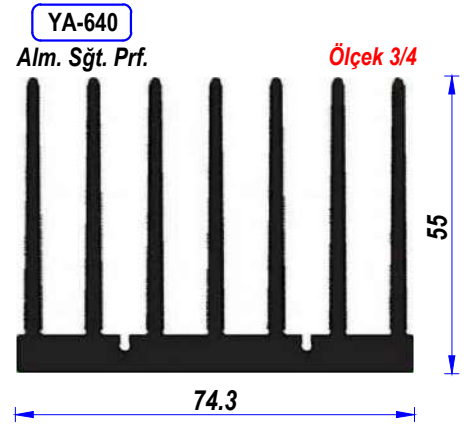
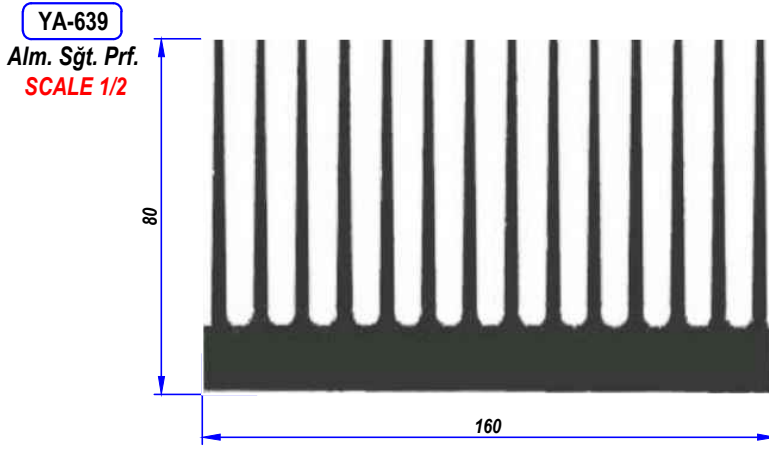
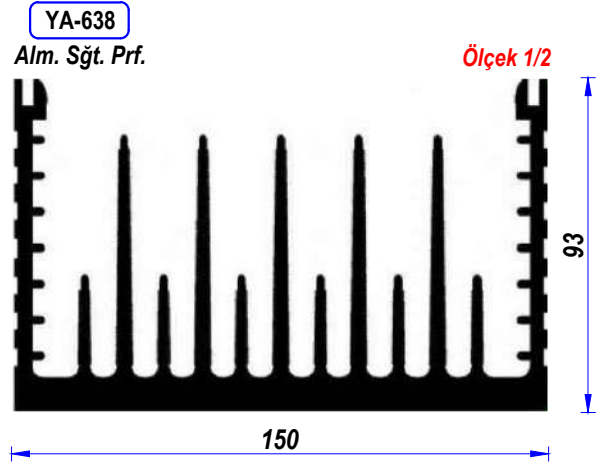
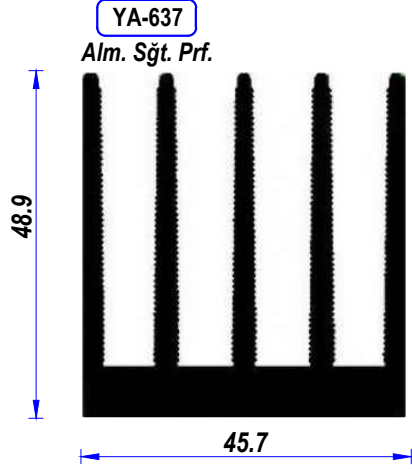

İstenilen ölçülerde kesim yapılır - Renkli eloksal kaplama yapılır
All cutting dimensions and surface coatings can be done according to requirements.

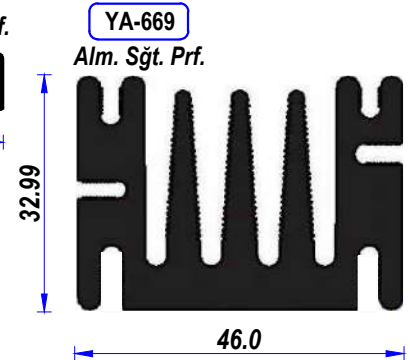
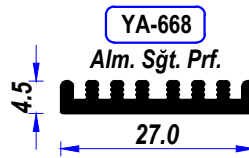
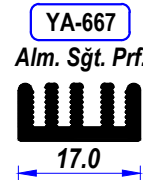
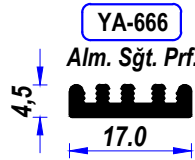
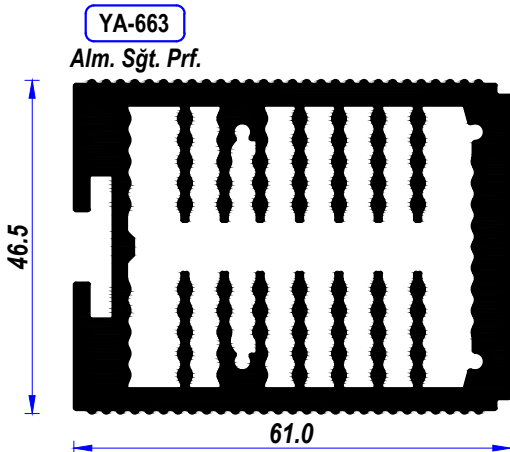
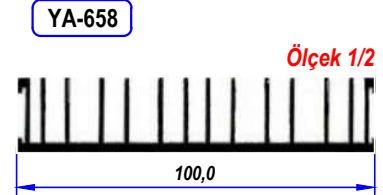
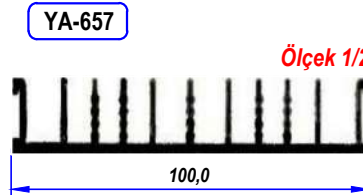
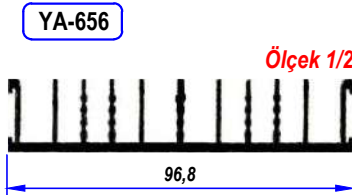
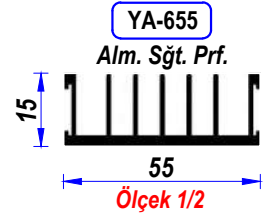
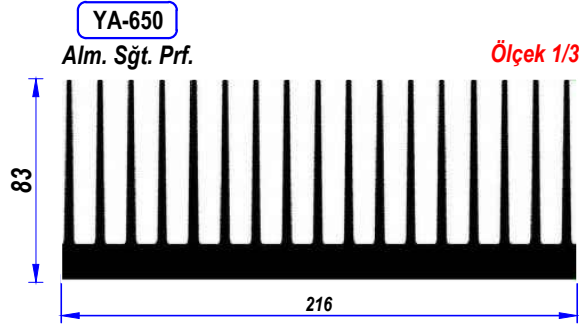
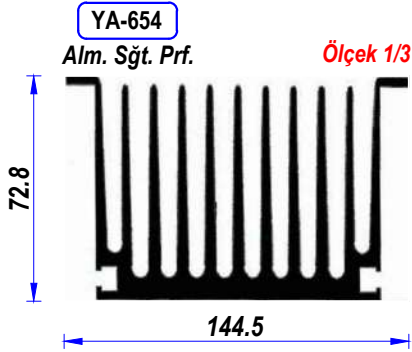
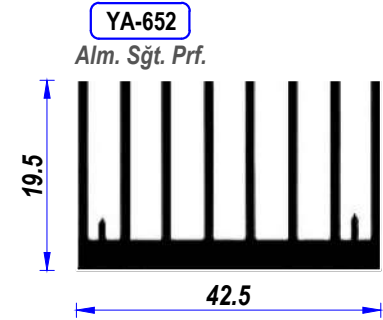
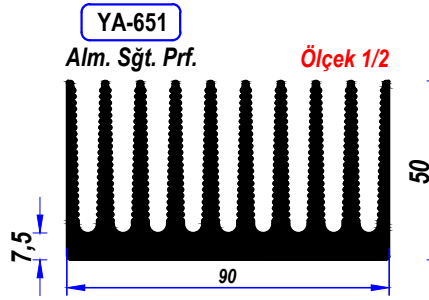
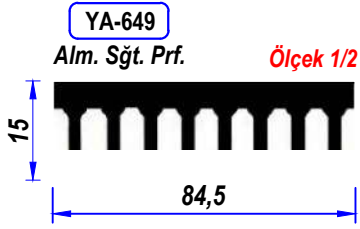
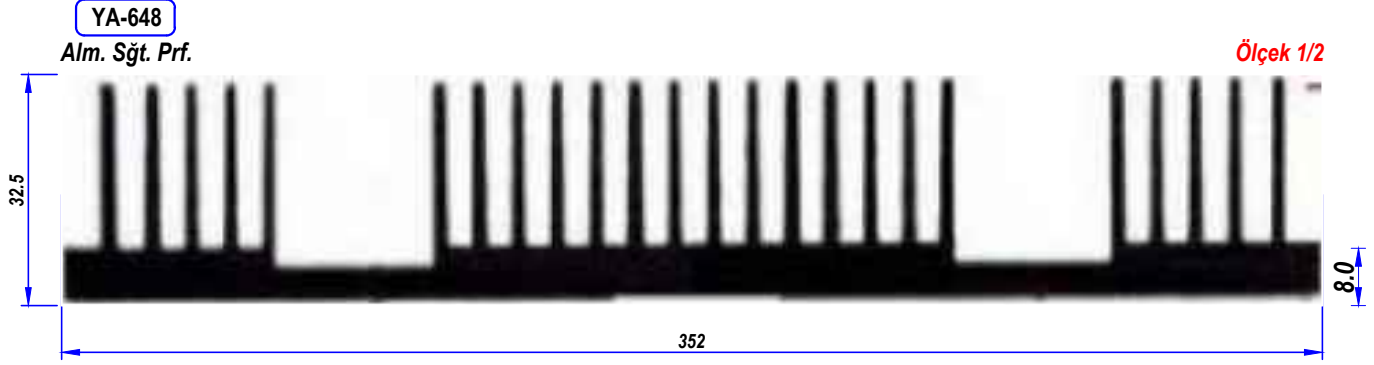

İstenilen ölçülerde kesim yapılır - Renkli eloksal kaplama yapılır
All cutting dimensions and surface coatings can be done according to requirements.

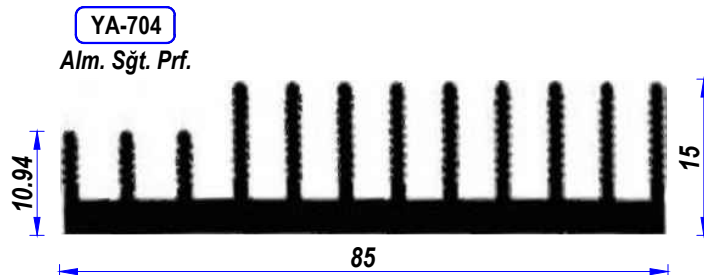
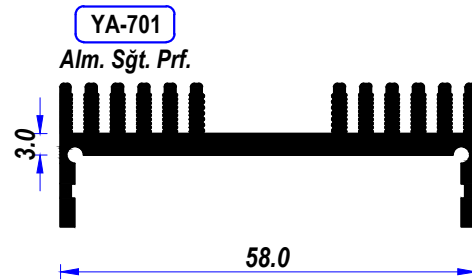
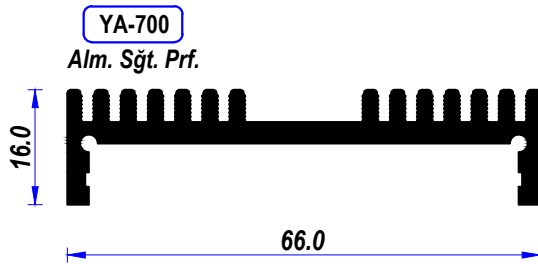
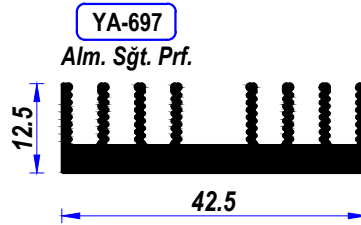
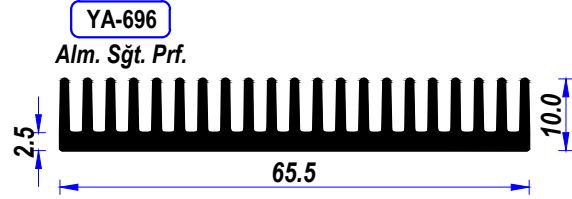
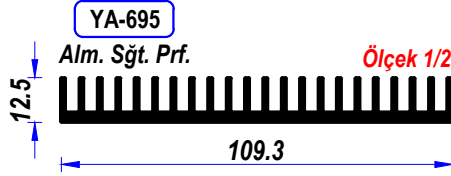
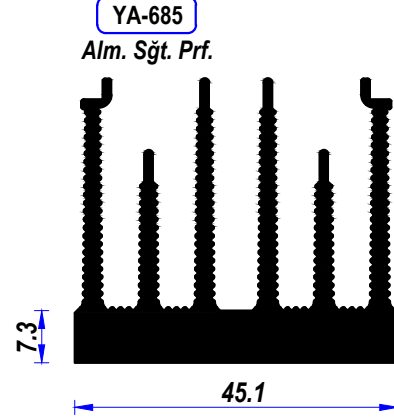
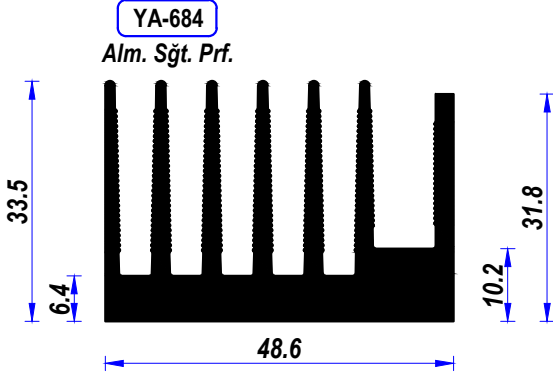
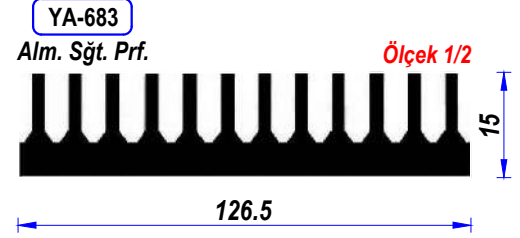
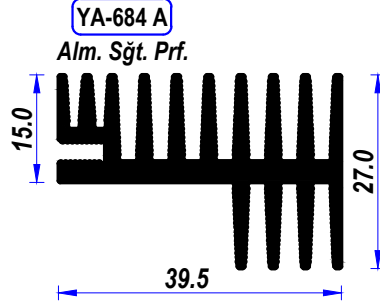
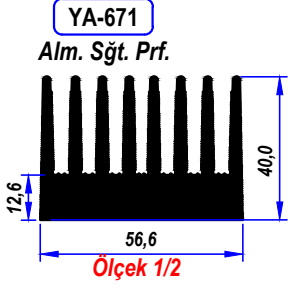

İstenilen ölçülerde kesim yapılır - Renkli eloksal kaplama yapılır
All cutting dimensions and surface coatings can be done according to requirements.

YA-706

Alm. Sğt. Prf.

Ölçek 1/2

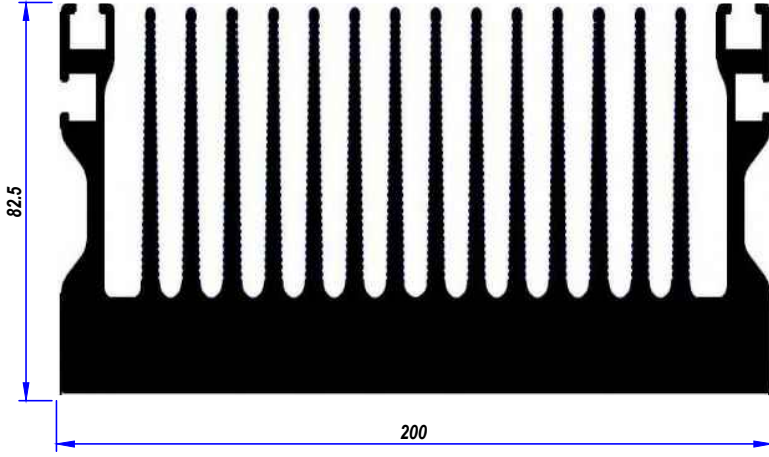

YA-705

Alm. Sğt. Prf.

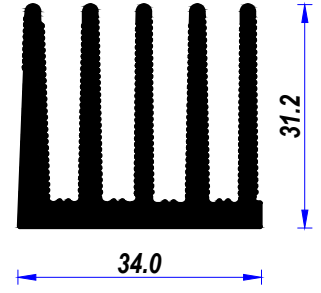

YA-707

Alm. Sğt. Prf.

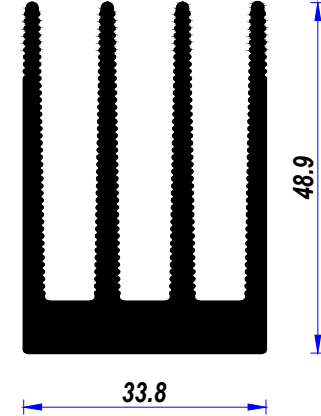

YA-708

Alm. Sğt. Prf.

Ölçek 1/2

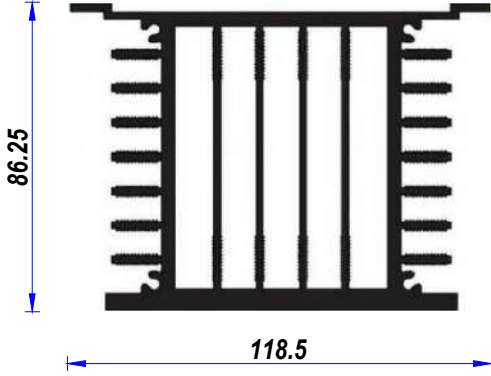

YA-715

Alm. Sğt. Prf.

Ölçek 1/2

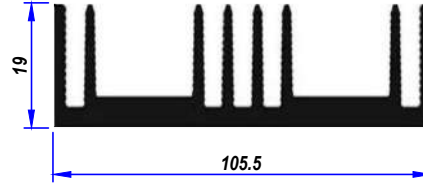

YA-707 A

Alm. Sğt. Prf.

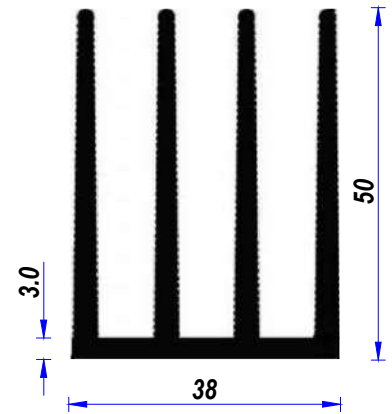

YA-710

Alm. Sğt. Prf.

Ölçek 1/2

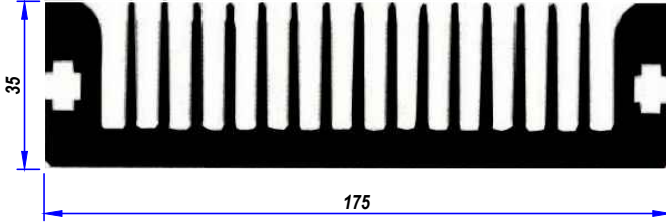

YA-714

Alm. Sğt. Prf.

Ölçek 1/2

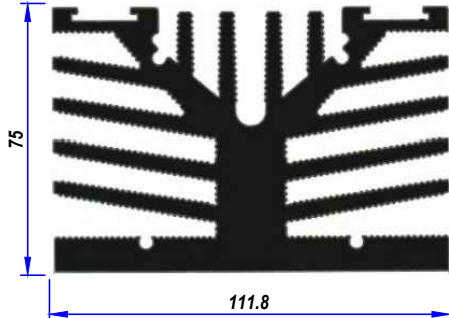

YA-709

Alm. Sğt. Prf.

Ölçek 3/4

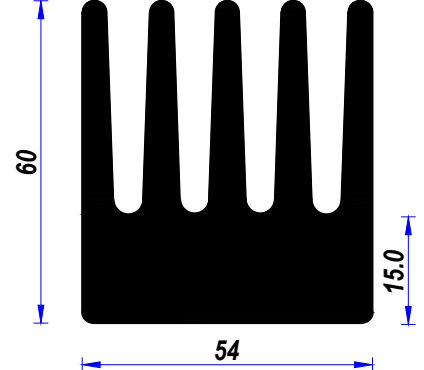

İstenilen ölçülerde kesim yapılır - Renkli eloksal kaplama yapılır
All cutting dimensions and surface coatings can be done according to requirements.

Ledaks®

YENİLİKÇİ ÇÖZÜM ÜRETİR

*Tüm hakları saklıdır
Katalogdaki bilgiler ve çizimler izinsiz kopyalanamaz
Ledaks katalogdaki ölçü ve tasarımları bilgi vermeksizin değiştirebilir*

Adres : Koçak Caddesi No : 71 Siteler Altındağ Ankara TÜRKİYE
Tel : +90 312 351 15 15 Whatsapp: +90 554 497 30 33 / 41 71
Web : www.ledaks.com Mail : info@ledaks.com