



Basorplast: Uses & Installation Practices

Usos y creación de accesorios REV.3



3E Basor
CABLE TRAY SPECIALIST





Index / Índice

USES USOS

3 / Introduction / Presentación

4-24 / Product uses / Usos del producto

1. Water Treatment
Tratamientos de Agua
2. Mining
Minería
3. Chemical Industry
Industria Química
4. Railways
Ferrocarriles
5. Solar Installations
Instalaciones Solares
6. Tertiary buildings
Edificios terciarios
7. Sea and Ports
Mar y Puertos
8. Machine Building
Construcción de maquinaria
9. Road infrastructures
infraestructuras viarias
10. Shore and Cost
Litoral y Costas
11. Metal Chemical Industry
Industria Química Metálica

25- 27 / Products that PVC can replace

Productos que el PVC puede sustituir

- Advantages
Ventajas
- Disadvantages
Desventajas

INSTALLATION PRACTICES CREACIÓN DE ACCESORIOS

28/ Cutting / Corte

29/ Tools and mounting accessories Herramientas y accesorios de montaje

30/ Straight Junctions / Uniones rectas

31/ Horizontal bends / Curvas planas

- a. Small radius / Radio corto
- b. Right radius / Radio recto
- c. Large radius / Radio largo
- d. Other radius / Otros radios

35/ Inside bends / Curvas cóncavas

- a. Small radius / Radio corto
- b. Right radius / Radio recto
- c. Large radius / Radio largo

38/ Outside bends / Curvas convexas

- a. Small radius / Radio corto
- b. Right radius / Radio recto
- c. Large radius / Radio largo

41/ Tee bends / Tés

42/ Cross bends / Cruces

43/ Elevation changes / Cambios de nivel

44/ Application on strut / Aplicación en perfil

- a. Solid bottom / Ciegas
- b. Slotted / Perforadas

46/ Product Catalogue / Catálogo de Productos

52/ Application on brackets / Aplicación en soporte

- a. Floor / Suelo
- b. Wall / Pared
- c. Ceiling / Techo

53-55/ Corporate information / Información corporativa

Introduction / Introducción

BPE 60x100 to 60x300



Models (HxB) / Modelos (AxB):

60x100; 60x150; 60x200; 60x300; 100x200; 100x300; 100x400; 100x600.

Types: Slotted or solid bottom / Tipos: Perforadas o ciegas

Finishes / Acabados: PVC UVM1 RAL 7035

Characteristics of the tray / Características de la bandeja:

- Non metallic system / Sistema no metálico
- Resistant to UV radiation UL568/ Resistente a los rayos UV UL568
- Excellent behaviour in outdoor / Excelente comportamiento al exterior
- Impact strength: 20J except 60x100 with 10J
Resistencia al impacto: 20J salvo 60x100 con 10J
- Minimum temperature / Temperatura mínima: -40°F (-40°C)
- Maximum temperature / Temperatura máxima: 140°F (60°C)
- Non-Flame propagating / No propagador de la llama
- No electrical continuity / Sin continuidad eléctrica
- Insulating / Aislante
- Dielectric Strength / Rigidez dieléctrica: 18+/-2 KV/mm
- High resistance to corrosion substances (DIN 8061 & ISO/TR 10358) / Alta resistencia a las sustancias corrosivas (DIN 8061 & ISO/TR 10358)
- M1 reaction to fire/ Reacción M1 al fuego: UNE 23727/UNE 201010
- Glow wire test / Test de hilo incandescente: 1760°F (960°C) EN 60695-2-11
- Flammability / Inflamabilidad: UL 94-VO, ANSI/UL 94-1995
- LOI > 50% EN ISO 4589
- Comply / Cumple: RoHS 2011/65/UE
- Raw material without silicone / Materia prima sin silicona

BPE 100x200 to 100x600



Working Loads: Recommendation (Cargas de trabajo: Recomendación)

MODELS	IEC 61537 SWL (CTA) kg/m (lb/ft)							
	Temp. Max 40°C (104°F)				Temp. Max 60°C (140°F)			
	1m span (Vano)		1,5 m span (Vano)		1m span (Vano)		1,5 m span (Vano)	
	Kg/m	Lb/ft	Kg/m	Lb/ft	Kg/m	Lb/ft	Kg/m	Lb/ft
BPE-60X100	38	26	24	16	28	19	10	7
BPE-60X150	39	26	25	17	30	20	12	8
BPE-60X200	67	45	38	26	36	24	16	11
BPE-60X300	74	50	45	30	40	27	21	14
BPE-100X200	121	81	77	52	62	42	34	23
BPE-100X300	123	83	89	56	75	50	38	26
BPE-100X400	178	120	102	68	88	79	48	32
BPE-100X600	212	142	121	81	108	73	58	39

NOTE: Tests according to IEC 61537 (limited deflection) Type III test, with 1.7 Safety factor
NOTA: Ensayos realizados según IEC 61537 (flecha máxima) Ensayo Tipo III con factor seguridad de 1.7

MODELS	NEMA	NEMA Cable Tray Classification (U.S) - UL 568 SWL kg/m (lb/ft)								
		Temp. Max 40°C (104°F)				Temp. Max 60°C (140°F)				
		1,8m (6 ft) span		2,4m (8 ft) span		1,8m (6 ft) span		2,4m (8 ft) span		
		Kg/m	Lb/ft	Kg/m	Lb/ft	Kg/m	Lb/ft	Kg/m	Lb/ft	
BPE-60X100	-	5,5	3,7	3,1	2,1	-	3,6	2,4	2,0	1,3
BPE-60X150	-	7,6	5,1	4,2	2,8	-	4,9	3,2	2,7	1,8
BPE-60X200	-	34,3	23,1	19,3	13,0	-	22,4	15,0	12,6	8,4
BPE-60X300	5AA	37,8	25,4	21,2	14,2	-	24,6	16,5	13,8	9,3
BPE-100X200	5A	59,0	39,6	33,1	22,3	5AA	38,4	25,8	21,6	14,5
BPE-100X300	8AA	93,2	62,6	52,4	35,2	5A	60,7	40,8	34,1	22,9
BPE-100X400	8A	144,6	97,2	81,3	54,6	8AA	94,2	63,3	53,0	35,6
BPE-100X600	8B	216,5	145,4	121,7	81,8	8A	141,0	94,7	79,3	53,3

NOTE: Tests acc. UL 568 Method A (Load Before Destruction), 1.5 Safety factor
NOTA: Ensayo s./ UL 568 Método A (Carga antes de destrucción), factor seguridad de 1,5

INSTRUCTIONS FOR USE

Assembly: H60 (2 union joints + 4 bolts) H100 (2 union joints + 8 bolts).

Installation: Not allowed under other canalisation such as water, vapour or gas.

Ventilation: Minimum distance between each tray of 250 mm.

Enviroments: Wet, salty and chemical.

Expansions: Depending of the expected growth in the temperatura (AT) leave a gap (h) between cable trays according to the following table.

INSTRUCCIONES DE USO

Ensamblado: H60 (2 uniones + 4 tornillos) H100 (2 uniones + 8 tornillos).

Instalación: No permitido bajo otras canalizaciones como agua, vapor o gas.

Ventilación: Distancia mínima entre bandejas de 250 mm.

Ambientes: Húmedos, salinos y químicos.

Expansiones: Dependiendo de las variaciones de temperature (AT) dejar un espacio (h) entre las bandejas acorde a la siguiente tabla:

Expected Temp. Growth	GAP	
	ΔT (°F)	h (mm)
36	20	5
54	30	7
72	40	9
90	50	11



Water treatment Tratamiento de aguas

Water treatment is any process that makes water more acceptable for a specific end-use such as drinking, industrial water supply, irrigation or others. PVC has the advantage of eliminating electrical risk, especially dangerous in humid environments. **These kind of places with a lot of humidity and sewage water, need materials such as PVC to avoid the corrosion and guarantee a long life of the installation.**

El tratamiento de aguas es cualquier proceso que mejora la calidad del agua para un uso final específico, ya sea para beberla, suministro industrial, riego etc. El PVC tiene la ventaja de la eliminación del riesgo eléctrico, especialmente peligroso en ámbitos húmedos.

Este tipo de lugares con una alta humedad y presencia de aguas residuales necesita de materiales como el PVC para evitar la corrosión y garantizar una vida larga de la instalación.

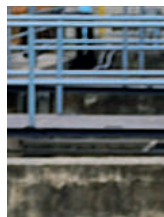



Desalination plants:

Saline water can be treated to yield fresh water. Two main processes are used, reverse osmosis or distillation. **The PVC trays are perfect to be installed because this material is not affected by salty environment.**

Desalinizadoras:

El agua salada puede ser tratada para convertirse en agua dulce. Dos procesos fundamentales se utilizan, la osmosis o la destilación. **Las bandejas de PVC son perfectas para ser instaladas en estas plantas dado que no se ven afectadas por el ambiente salino.**



Pumping stations:

Pumping stations are facilities including pumps and equipment for pumping fluids from one place to another such at canals or stored liquid areas as well as the drainage of low-lying land. **These places need non metallic trays due the big humidity of the environment.**

Plantas de bombeo:

Las estaciones de bombeo son instalaciones que incluyen bombas y equipos para bombear fluidos de un lugar a otro como canales o áreas con líquidos estancados, así como para el drenaje de tierras bajas. **En estos lugares es recomendable el uso de bandejas no metálicas debido a la alta humedad del ambiente.**

Wastewater treatment

Is a process used to convert water no longer needed into an effluent that can be either returned to the water cycle with minimal environment issues removing the impurities. This process generates a lot of gases. **These gases are corrosive, for this reason the PVC trays is the most efficient solution to this environments, as shown in the documents ISO / TR 10358 or the DIN 8061 standard**

Tratamiento de fecales

Es un proceso usado para convertir el agua que ya no se necesita en un afluente que puede ser devuelto al ciclo del agua sin apenas problemas ambientales gracias a la eliminación de las impurezas. Este proceso genera una gran cantidad de gases. **Estos gases son corrosivos, por lo que las bandejas de PVC son la solución más eficiente a estos ambientes tal y como demuestran los documentos ISO/TR 10358 o la norma DIN 8061.**



Pools

Is a structure designed to hold liquids. Pools can be built into the ground or above. **In the maintenance of these facilities, the use of chemical products such as chlorine is very usual, PVC trays are the perfect products for these environments, for both chemical resistance and electrical safety.**

Piscinas

Es una estructura diseñada para mantener líquidos. Las piscinas se pueden construir en el suelo o elevadas. **En el mantenimiento de estas instalaciones, el uso de productos químicos como el cloro es muy habitual, las bandejas de PVC son los productos perfectos para estos entornos, tanto por la resistencia química como por la seguridad eléctrica.**

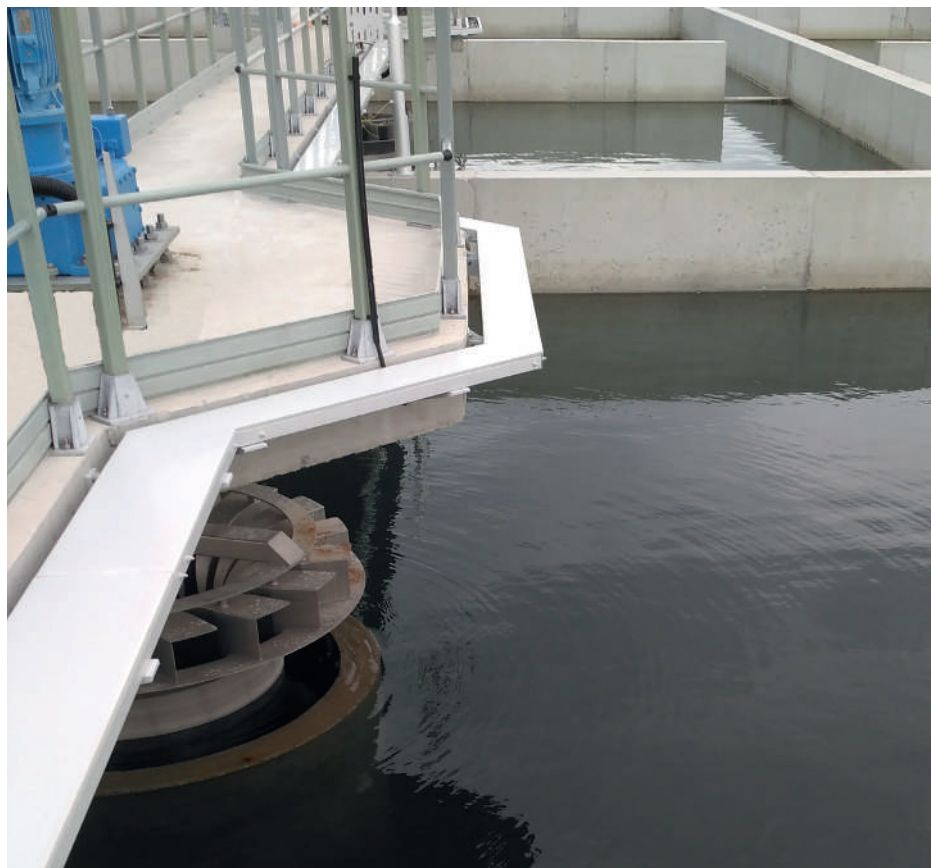



Mining Minería



Mining is the extraction of commercially valuable minerals or other types of geological materials located on land and any non-renewable resource such as oil, natural gas or even water. **The trays manufactured in PVC are the most suitable products given the wet nature of this type of installations, since they present a null affection to the corrosion that occurs in the environment.**

La minería es la extracción de minerales con valor comercial u otros tipos de materiales geológicos ubicados en la tierra y cualquier recurso no renovable como el petróleo, gas natural o incluso agua. **Las bandejas fabricadas en PVC son los productos más convenientes dado la naturaleza húmeda de este tipo de instalaciones, ya que presentan una nula afcción a la corrosión que se produce en el ambiente.**





Chemical industry Industria química



The chemical industry converts raw materials (oil, natural gas, air, water, metals, and minerals) into more than 70,000 different products through chemical processes. **These chemical environments produce very aggressive atmospheres that affect a lot to the metals, the PVC cable trays are perfect due the big resistance against this chemically aggressive environment, as demonstrated in ISO/TR 10358.**

La industria química convierte las materias primas (petróleo, gas natural, aire, agua, metales y minerales) en más de 70.000 productos diferentes a través de procesos químicos. **Estos ambientes químicos producen atmósferas muy agresivas que afectan mucho a los metales, las bandejas de PVC son perfectas debido a la gran resistencia contra este ambiente químicamente agresivo, como se demuestra en el documento ISO/TR 10358.**





Petrochemicals

Also called petroleum distillates, are chemical products derived from petroleum and other fossil fuels, such as coal or natural gas, or renewable sources such as corn or sugar cane. **The processes are made thanks to an aggressive distillate that generates humid environments with the presence of petroleum-derived chemicals that are very aggressive for metals, PVC trays are the best solution as indicated by the IEC 61537 standard, they are corrosion resistant.**

Petroquímicas

También llamados destilados de petróleo, son productos químicos derivados del petróleo y otros combustibles fósiles, como carbón o gas natural, fuentes renovables como el maíz o la caña de azúcar. **Los procesos se realizan gracias a un destilado agresivo que genera ambientes de humedad con presencia de químicos derivados del petróleo que son muy agresivos para los metales, las bandejas de PVC son la mejor solución ya que, tal y como indica la norma IEC 61537, son resistentes a la corrosión.**

The pharmaceutical

This industry develops pharmaceutical drugs for use as medications. They are subject to a variety of laws and regulations by the govern about the patenting, testing, safety, efficacy, marketing and production of the drugs. **In the production processes of synthesized drugs with acids, only the non-metal trays as PVC cable trays can be installed thanks to the resistance against acids. n addition, cleaning these types of locations makes the use of metals inadvisable as they can end up with corrosion.**

Farmacéutica

Esta industria desarrolla fármacos para su uso como medicamentos. Están sujetos a una variedad de leyes y regulaciones por parte del gobierno sobre patentes, pruebas, seguridad, eficacia o comercialización. **En los procesos de producción de fármacos sintetizados con ácidos, sólo se pueden instalar las bandejas no metálicas como bandejas de PVC gracias a la alta resistencia frente a ácidos. Además, la limpieza de este tipo de ubicaciones hace desaconsejable el uso de metales ya que pueden acabar presentando corrosión.**





BASORPLAST

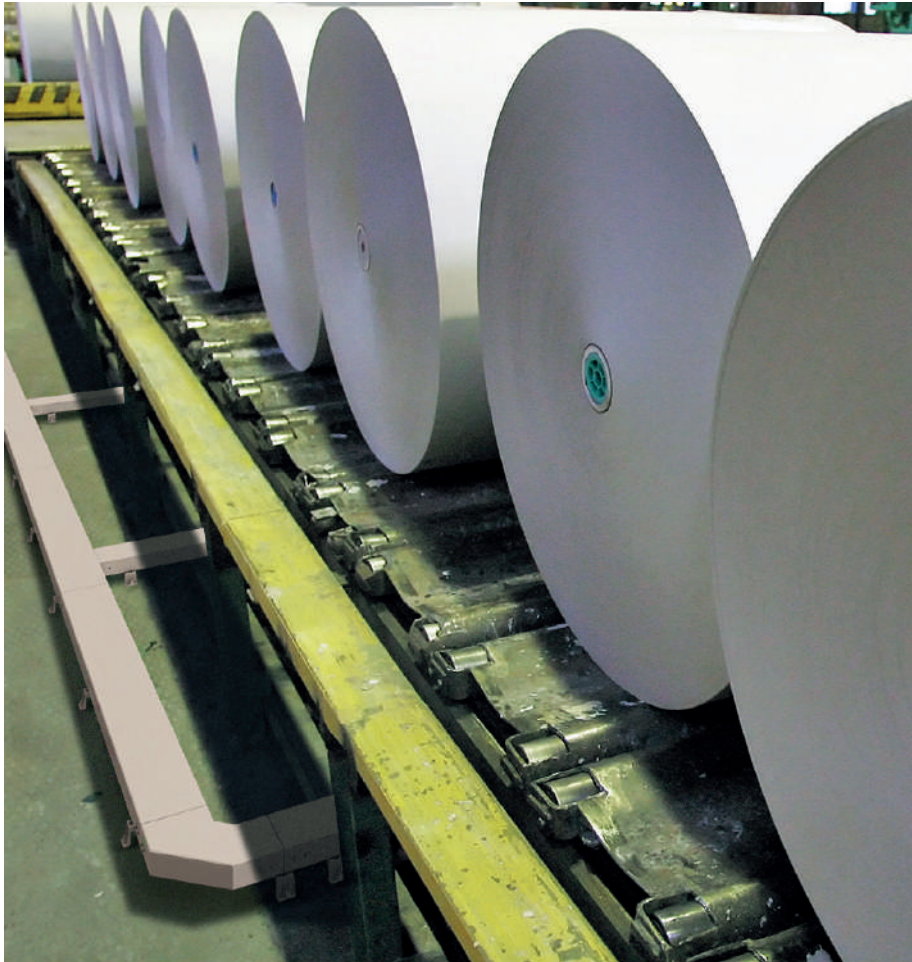

The pulp and paper industry

Comprises companies that use wood as raw material and produce pulp, paper, board and other cellulose based products. The papermaking process has a low environmental impact, while the paper is not bleached. Bleaching requires the use of hydrogen peroxide, or chlorine dioxide, two highly polluting and aggressive substances. **The PVC cable trays are specially designed and formulated to respond to these environments with hardness and durability.**

Industria papelera

Comprende las empresas que utilizan la madera como materia prima y producen pulpa, papel, cartón y otros productos a base de celulosa. El proceso de fabricación del papel tiene un bajo impacto ambiental, mientras que el papel no se blanquee. El blanqueo requiere el uso de peróxido de hidrógeno, o dióxido de cloro, dos sustancias altamente contaminantes y agresivas. **Las bandejas portacable de PVC están especialmente diseñadas y formuladas para responder a estos entornos de alta dureza.**

A fertilizer

A fertilizer is any material of natural or synthetic origin that is applied to soils or to plant tissues to supply one or more plant nutrients essential to the growth of plants. This goal is met in two ways, additives that provide nutrients or modifying the water retention and aeration. **These plants where the fertilizers are made, produce acid and alkaline environments, the PVC cable trays are the best solution due the proven resistance against these environments.**

Plantas de fertilizantes

Un fertilizante es cualquier material de origen natural o sintético que se aplica a los suelos o a los tejidos vegetales para suministrar uno o más nutrientes para el crecimiento de las plantas. Este objetivo se cumple de dos maneras, con aditivos que proporcionan nutrientes o modificando la retención de agua y la aireación. **Las plantas donde se fabrican los fertilizantes, producen ambientes ácidos y alcalinos, las bandejas de PVC son la mejor solución debido a la resistencia demostrada ante estos ambientes.**





Railways infrastructures Infraestructuras ferroviarias



Rail transport is a means of conveyance of passengers and goods on wheeled vehicles running on rails, also known as tracks. It is also commonly referred to as train transport. Tracks, stations, catenaries and substations are the most important infrastructures for the railways industry. **The PVC cable trays are specially designed for outdoor installations as tracks or catenaries and indoor as stations or substations, places where humidity can be high affecting metals and where electrical safety is essential.**

El transporte ferroviario es un medio de transporte de pasajeros y mercancías en vehículos de ruedas que circulan sobre carriles, también conocidos como vías. También se refiere comúnmente como transporte en tren. Las vías, estaciones, catenarias y subestaciones son las infraestructuras más importantes para la industria ferroviaria. **Las bandejas de PVC están especialmente diseñadas para instalaciones al aire libre como vías o catenarias e interiores como estaciones o subestaciones, lugares donde la humedad puede ser alta afectando a los metales y donde la seguridad eléctrica es fundamental.**





Solar installations Instalaciones solares

The solar energy is the energy obtained by the light and heat catchment made by the sun. These installations transform the solar radiation into electrical energy through photovoltaic panels, making possible the accumulation into batteries. All these installations are outdoor, where the inclement weather affect directly. **PVC insulating cable trays are the safest option for photovoltaic installations that use direct current, being a lightweight solution that does not overload the cover.**

La energía solar es la energía obtenida por la captación de luz y calor hecha por el sol. Estas instalaciones transforman la radiación solar en energía eléctrica a través de paneles fotovoltaicos, posibilitando la acumulación en baterías. Todas estas instalaciones están al aire libre, donde las inclemencias climáticas afectan directamente. **Las bandejas aislantes de PVC son la opción más segura para instalaciones fotovoltaicas que emplean corriente continua, siendo una solución ligera que no sobrecarga en peso la cubierta.**

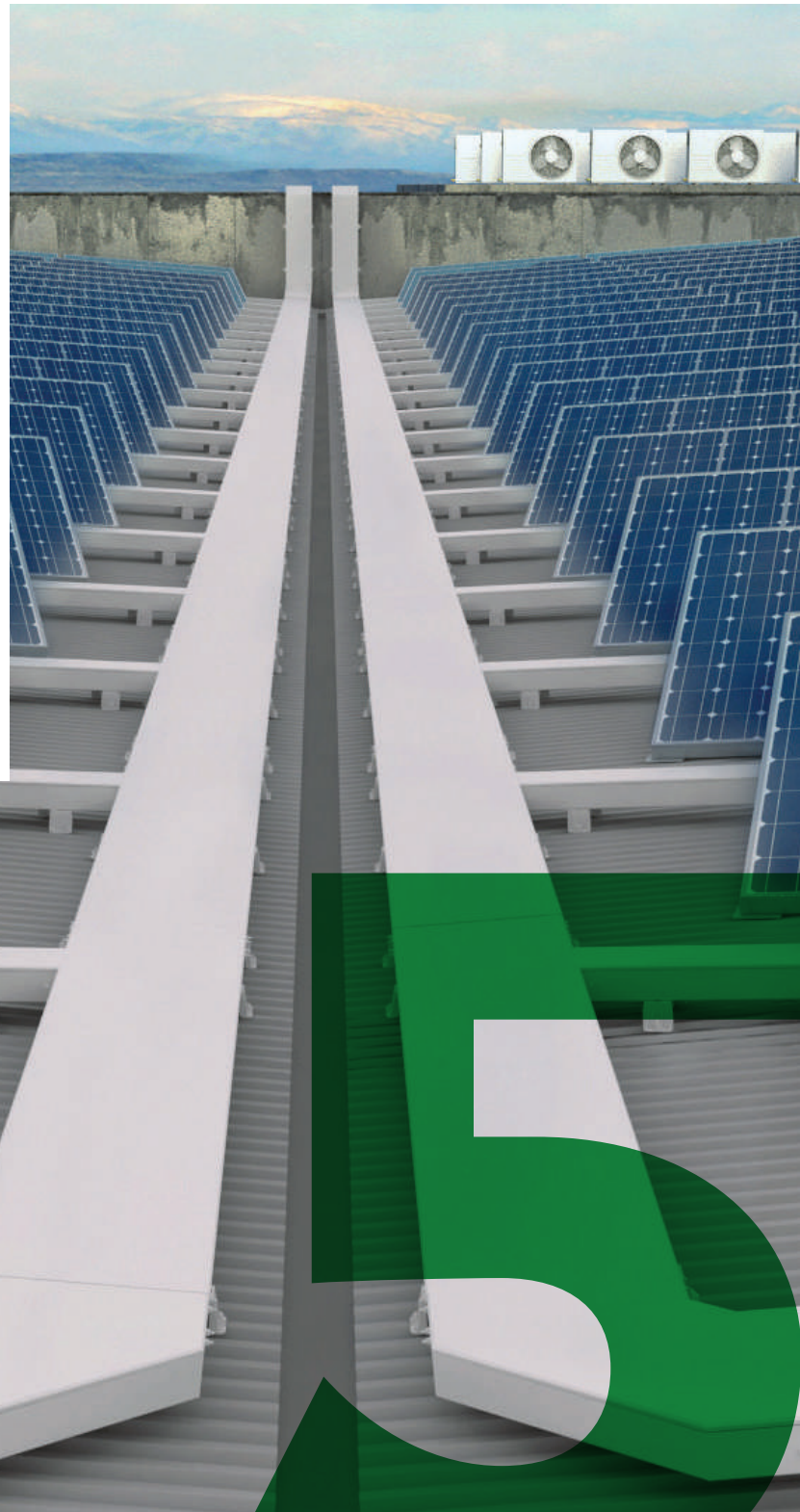



BASORPLAST



Rooftop

A rooftop photovoltaic power station, is a photovoltaic system that has its electricity-generating solar panels mounted on the rooftop of a residential or commercial building or structure, with horizontal or tilted form. **The PVC cable trays are the most fast and practical form to manage the cable installation due the easier to construct the way to the solar panels.**

Azotea

Una central fotovoltaica en la azotea, es un sistema fotovoltaico que tiene sus paneles solares generadores de electricidad montados en el tejado de un edificio residencial o comercial, con forma horizontal o inclinada. **Las bandejas de PVC son la forma más rápida y práctica para gestionar la instalación de los cables debido a que es muy sencillo crear la canalización hacia los paneles solares.**



Solar Farm

A Solar Farm is a photovoltaic power station, with a large-scale photovoltaic system designed for the supply of merchant power into the electricity grid at the utility level, rather than to a local user or users. **The PVC cable trays are the most fast and practical form to manage the cable installation due the easier to construct the way to the solar panels.**

Granja Solar

Una granja solar es una central fotovoltaica, con un sistema fotovoltaico a gran escala diseñado para el suministro de energía comercial en la red eléctrica a nivel de suelo. **Las bandejas de PVC son la forma más rápida y práctica para gestionar la instalación de los cables debido a que es muy sencillo crear la canalización hacia los paneles solares.**



Battery rooms

Electric accumulators are responsible for storing the energy generated by solar panels and must have sufficient capacity to ensure the supply of electricity during periods of clouds. **PVC cable trays are the safest and most practical way to manage the installation of cables due to its insulating and cannot produce any type of electroshock.**

Salas de acumuladores

Los acumuladores eléctricos son los encargados de almacenar la energía generada por los paneles solares y deben tener suficiente capacidad para asegurar el suministro de electricidad durante períodos de nubes. **Las bandejas de PVC son la forma más segura y práctica para gestionar la instalación debido a que son aislantes y no pueden producir ningún tipo de electroshock.**



Solar tanks

The installation of photovoltaic plants in the high part of tanks, allows to capture solar energy for its subsequent connection to the electricity grid. **The PVC cable trays are the most fast and practical form to manage the cable installation due the easier to construct the way to the solar panels.**

Tanques solares

La instalación de centrales fotovoltaicas en la parte superior de tanques o silos, permite captar la energía solar para su posterior conexión a la red eléctrica. **Las bandejas de PVC son la forma más rápida y práctica para gestionar la instalación de los cables debido a que es muy sencillo crear la canalización hacia los paneles solares.**

Floating PV

Floating photovoltaic plants are an emerging form of photovoltaic systems that float on the surface of drinking water reservoirs, lakes, dams, irrigation canals, and waste ponds. **This kind of installation is affected by the humidity, the PVC cable trays are the best solution against the oxidation.**

PV flotante

Las plantas fotovoltaicas flotantes son una forma emergente de sistemas fotovoltaicos que flotan en la superficie de depósitos de agua potable, lagos, presas, canales de riego y balsas de residuos. **Este tipo de instalación se ve afectada por la alta humedad, las bandejas de PVC son la mejor solución contra la oxidación.**

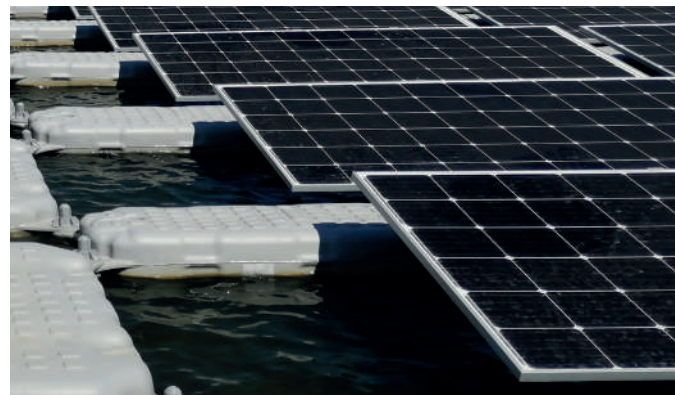



Tertiary buildings Edificios terciarios



The tertiary buildings are those properties that are intended for one or more economic activities, whose purpose is the provision of services to the public, companies and organizations. **The PVC cable trays are specially designed to be versatile in any type of installation both inside and outside of any type of tertiary building.**

Los edificios terciarios son aquellos inmuebles que son destinados a una o varias actividades económicas, cuya finalidad es la prestación de servicios al público, a las empresas y a los organismos. **Las bandejas de PVC están especialmente diseñadas para ser versátiles en cualquier tipo de instalación tanto al interior como al exterior de cualquier tipo de edificación terciaria.**





Sea and ports infrastructure Infraestructuras de mar y puertos



A port infrastructure is a location on a coast or shore containing one or more harbours where ships can dock and transfer people or cargo to or from land. Port locations are selected to optimize access to land and navigable water, for commercial demand, and for shelter from wind and waves. **The PVC trays are perfect to be installed due the salt environments does not affect to the thermoplastic.**

Una infraestructura portuaria es una ubicación en la costa donde se alojan los puertos, lugares donde los buques pueden atracar e intercambiar carga o pasajeros desde o hacia tierra. Las localizaciones portuarias están especialmente optimizadas para la protección ante vientos y oleaje y mejorar la navegabilidad y las cargas/descargas de personas y mercancías. **Las bandejas de PVC son perfectas para ser instaladas debido a que los ambientes salinos no afectan al termoplástico**





BASORPLAST



Harbour crane

Is a type of machine, generally equipped with a hoist rope, wire ropes or chains, and sheaves, that can be used both to lift and lower materials and to move them horizontally. It is mainly used for lifting heavy things and transporting them to other places. **Cranes are commonly affected by the salty winds, the PVC cable trays are the best solution against the oxidation thanks to its corrosion resistance.**

Grúa Portuaria

Es un tipo de máquina, generalmente equipada con cuerdas de polipasto o cadenas metálicas y poleas, que pueden usarse tanto para elevar elementos pesados y bajar materiales como para moverlos horizontalmente. Se utiliza principalmente para elevar elementos pesados y transportarlas a otros lugares. **Las grúas son comúnmente afectadas por los vientos salados, las bandejas de PVC son la mejor solución contra la oxidación gracias a su resistencia a la corrosión.**



Dam barrier

Is a barrier that impounds water or underground streams. Hydropower is often used in conjunction with dams to generate electricity. **Dams generally are very humid and salt windy areas where the PVC cable trays does not affect it and are the best solution for these kind of works.**

Presas

Es una barrera que impide el paso de agua o arroyos subterráneos. La energía hidroeléctrica usa la fuerza del agua para generar electricidad. Las presas son zonas muy húmedas y se ven afectadas por viento salado. **Las bandejas de PVC no sufren deterioro ante estos elementos y son la mejor solución para estas obras.**

Dock

A dock is either the area of water between or next to a human-made structure or group of structures involved in the handling of boats or ships, usually on or close to a shore, or the structures themselves. **Docks are very humid areas where the PVC cable trays does not affect it and they provide additional electrical safety.**

Muelle

Un muelle es el área de agua entre o junto a una estructura o grupo de estructuras, hechas por el hombre y destinadas al atraque de embarcaciones o barcos, generalmente cerca de una orilla. **Los muelles son áreas muy húmedas donde las bandejas de PVC no se ven afectadas y suponen una seguridad eléctrica adicional.**



Boarding Bridge

Is a platform used to the entry the passengers onto a watercraft that can be located in harbour or at sea. Boarding starts with entering of the first passenger and ends with the seating of each passenger and closure of the doors. **Boarding bridges are considered places of public attendance, therefore, PVC trays provide extra electrical safety in cable management.**

Plataforma de acceso

Es una plataforma utilizada para la entrada de los pasajeros en una embarcación que puede estar situada en puerto o en el mar. El embarque comienza con la entrada del primer pasajero y termina con el asiento de cada pasajero y el cierre de las puertas. **Los puentes de embarque son considerados lugares de pública concurrencia con lo cual, las bandejas de PVC suponen una seguridad eléctrica extra en la gestión de cables.**





Machine building Construcción de maquinaria

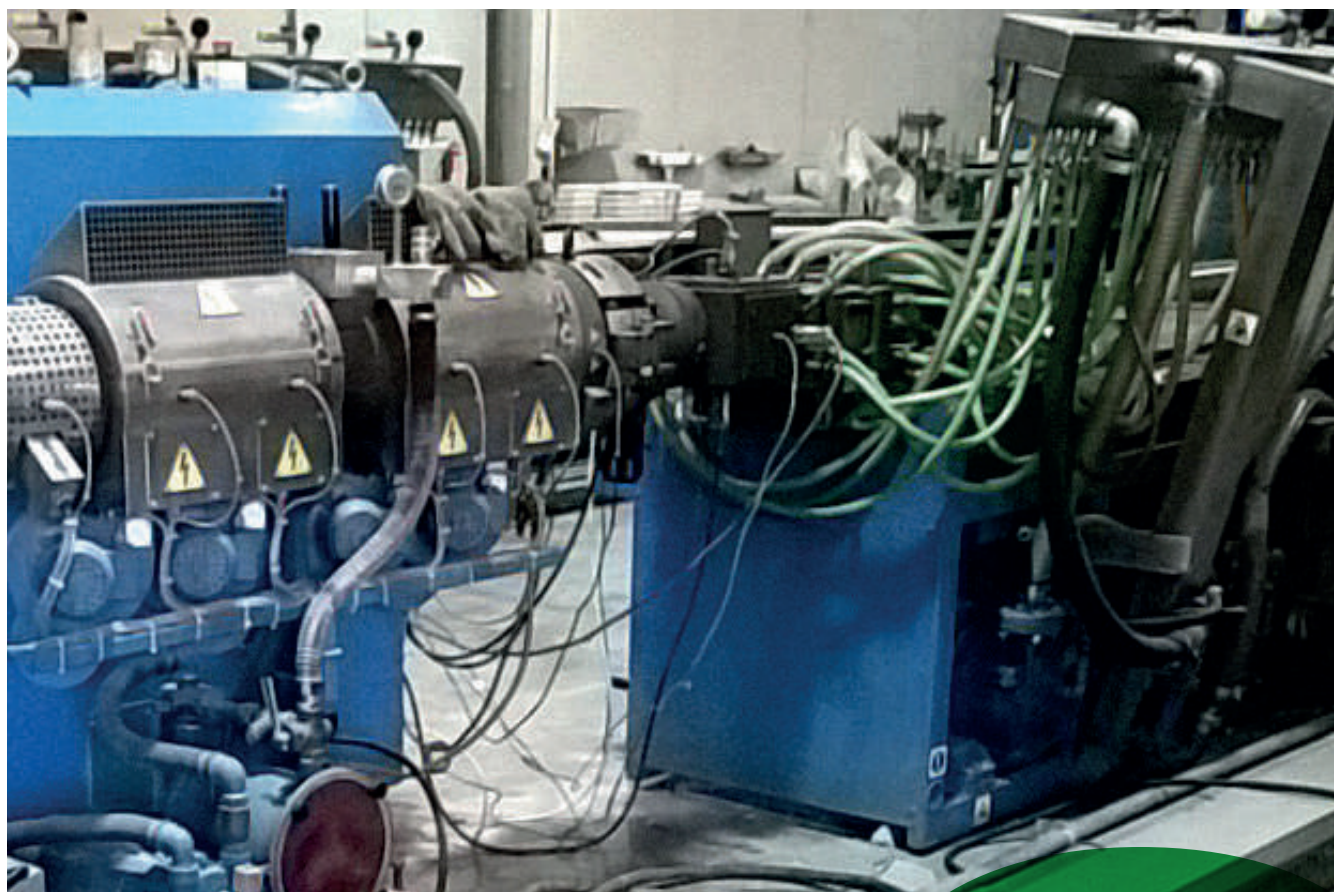

The machine industry is a subsector of the industry, that produces and maintains machines for consumers, the industry, and most other companies in the economy. There are a strong sector for the machinery with water in process. **These machines and its functions, produce humid environments where the PVC cable trays are the correct option to manage the cables installation due its resistance to humidity.**

La industria de construcción de maquinaria es un subsector de la industria, que produce y mantiene las máquinas para los consumidores, la industria y la mayoría de las empresas en la economía. Hay un sector especialmente reseñable que es el de la maquinaria con agua en proceso. **Estas máquinas y sus funciones, producen entornos húmedos donde las bandejas de PVC son la opción correcta para gestionar la instalación de cables debido a su resistencia a la humedad.**





Road infrastructures Infraestructuras viales

The road infrastructure is the whole set of elements that allows the movement of vehicles in a comfortable and safe way from one point to another. We understand it such as roads, highways, private highways and their different connection infrastructures. **These infrastructures are mostly outdoors, where the incidence of humidity can be high, PVC trays are the perfect insulating solution for this type of facility.**

La Infraestructura vial es todo el conjunto de elementos que permite el desplazamiento de vehículos en forma confortable y segura desde un punto a otro. Entendemos como tal las carreteras, autovías, autopistas y sus diferentes infraestructuras de enlace. **Estas infraestructuras se encuentran mayoritariamente a la intemperie, donde la incidencia de la humedad puede llegar a ser alta, las bandejas de PVC son la solución aislante perfecta para este tipo de instalaciones.**





Shore and cost infrastructure Infraestructuras costeras y de litoral



Shore or a shoreline is the fringe of land at the edge of a large body of water, such as an ocean, sea, or lake. In physical oceanography, a shore is the wider fringe that is geologically modified by the action of the body of water past and present, while the beach is at the edge of the shore, representing the intertidal zone where there is one. **These kind of areas suffer the effect of the salty winds, the PVC cable trays do not affected by the oxidation that the salt produce in metals, for this reason, is the best option to be installed in front of the sea.**

La costa o el litoral es una franja de tierra en el borde de un gran cuerpo de agua, como un océano, mar o lago. En la oceanografía física, una costa es la franja geológicamente modificada por la acción de la masa de agua, mientras que la orilla está en el borde de la masa de agua. **Este tipo de áreas sufren el efecto de los vientos salados, las bandejas de PVC no se ven afectadas por la oxidación que produce la sal en los metales, por esta razón, es la mejor opción para instalarse frente al mar.**





BASORPLAST



HOTEL

A hotel is an establishment that provides lodging paid on a short-term basis. Facilities provided may range from a modest-quality mattress in a small room to large suites. The hotels located at beach areas or near from the sea, are affected directly by the humid and the salty winds every day. **The PVC cable trays are specially designed to not be affected by these situation, being the best option for this kind of installation.**

HOTEL

Un hotel es un establecimiento que ofrece alojamiento pagado a corto plazo. Las instalaciones pueden variar desde un alojamiento de calidad modesta en una habitación pequeña a grandes suites. Los hoteles situados en las zonas de playa o cerca del mar, se ven afectados directamente por los vientos húmedos y salados todos los días. **Las bandejas de PVC están especialmente diseñadas para no verse afectadas por esta situación, siendo la mejor opción para este tipo de instalación.**



OTHER BUILDINGS

Types can include office buildings, warehouses, or retail. In beach locations, a commercial building often combines functions, such as an apartments on levels 2-10, with retail on floor 1. The buildings located at beach areas or near from the sea, are affected directly by the humid and the salty winds every day. **The PVC cable trays are specially designed to not be affected by these situation, being the best option for this kind of installation.**

OTROS EDIFICIOS

Pueden incluir edificios de oficinas, almacenes, o venta al por menor. En los lugares de playa, un edificio comercial a menudo combina funciones tales como apartamentos en los niveles 2-10, con venta al por menor en las plantas bajas. Los edificios situados en las zonas de playa o cerca del mar, se ven afectados directamente por los vientos húmedos y salados cada día. **Las bandejas de PVC están especialmente diseñadas para no verse afectadas por esta situación, siendo la mejor opción para este tipo de instalación.**





Metal chemical industry Industria química metálica



The production of metals involves the chemical processing to extract the metal that contain, and the mixture of metals, sometimes with other elements to produce alloys. **These process are highly aggressive due the sulphur generated, the PVC cable trays are the most convenient solution thanks to the big resistance against it.**

La producción de metales implica el procesamiento químico para extraer el metal que contiene una materia prima así como otros elementos para producir aleaciones. **Estos procesos son muy agresivos debido al azufre generado, las bandejas de PVC son la solución más conveniente gracias a la gran resistencia contra este elemento.**





Metallurgy

Is a domain of materials science and engineering that studies the physical and chemical behaviour of metallic elements, their intermetallic compounds, and their mixtures, which are called alloys. The production of metals involves chemical processing to produce alloys. **These processes produce zinc and lead atmospheres, the PVC cable trays are designed to hold on these environments with a long life.**

Metalúrgica

La metalurgia es la ciencia de los materiales cuya ingeniería estudia el comportamiento físico y químico de los elementos metálicos, sus compuestos intermetálicos, y sus mezclas (llamadas aleaciones). La producción de metales implica procesamiento químico para producir aleaciones. Estos procesos producen ambientes de zinc y plomo. **Las bandejas de PVC están diseñadas para soportar en estos entornos con una larga vida útil.**

Electrolytic Refining

An electrolytic process is the use of electrolysis industrially to refine metals or compounds at a high purity and low cost. Some examples are the Hall-Héroult process used for aluminium, or the production of hydrogen from water. **These processes generate humidity environments, the PVC cable trays does not affect it and are the best solution for these works.**

Refinamiento electrolítico

Un proceso electrolítico es el uso de electrólisis industrial para refinar metales o compuestos con una alta pureza y bajo coste. Algunos ejemplos son el proceso Hall-Héroult usado para el aluminio, o la producción de hidrógeno a partir del agua. **Estos procesos generan ambientes de humedad, las bandejas de PVC no se ven afectadas y son la mejor solución para estos trabajos.**





BASORPLAST

Other auxiliary processes:

- **Natural-gas** processing is a complex industrial process designed to clean raw natural gas by separating impurities and various non-methane hydrocarbons and fluids to produce what is known as pipeline quality dry natural gas.
- **Electroslag remelting (ESR)**, also known as electro-flux remelting, is a process of remelting and refining steel and other alloys for mission-critical applications in aircraft, thermal power stations, nuclear power plants, military technology... **The PVC cable trays are the best solution for the gas and electroslag environments due to its high resistance to the gas and remelting effects.**

Otros procesos auxiliares:

- El procesamiento de **gas natural** es un complejo proceso industrial diseñado para limpiar el gas natural bruto mediante la separación de impurezas y varios hidrocarburos y fluidos no metánicos para producir lo que se conoce como gas natural seco de gasoducto.
- **La refusión electrostática (ESR)**, también conocida como refundición de electrofusión, es un proceso de refundición y refinado del acero y otras aleaciones para aplicaciones en aviones, centrales térmicas, centrales nucleares, tecnología milita... **El PVC como material de fabricación en las bandejas es la mejor solución para los ambientes de gas y refusión debido a su alta resistencia al gas ya los efectos de refundición.**



- **A cooling tower** is a heat rejection device that rejects waste heat to the atmosphere through the cooling of a water stream to a lower temperature.
- **A galvanization plant** or treatment plant is a common place to put extra coatings to the metals. These processes produce vapours and aggressive environments.

The PVC cable trays are the most convenient material for vapour atmosphere thanks to the good behaviour at humid environments.

- **Una torre de enfriamiento** es un dispositivo de rechazo de calor que vierte cierto calor residual a la atmósfera gracias a un proceso de enfriamiento mediante una corriente de agua a una temperatura más baja.
- **Una planta de galvanización** o una planta de tratamiento es un lugar para poner recubrimientos adicionales a los metales. Estos procesos producen vapores y ambientes agresivos.

Las bandejas de PVC son el material más conveniente para la atmósfera de vapor gracias al buen comportamiento en ambientes de este estilo.





BASORPLAST

Products that the PVC tray can replace Productos que el PVC puede reemplazar

The PVC cable trays can replace other materials with a high resistance against the corrosion, salinity or humidity like **Fiberglass, stainless steel 304, stainless steel 316 or aluminum.**

Las bandejas de PVC pueden reemplazar otros materiales con alta resistencia ante corrosión, salinidad o humedad. **Como fibra de vidrio, acero inoxidable 304, acero inoxidable 316 o aluminio.**





BASORPLAST

Main Advantages:

Excellent corrosion behavior for chemical and saline environment

Electrical safety: Insulating material, earthing not required. Specially important in installations in areas where there are access for people. In a metal tray with a bad grounding, or coincide in the middle of 2 crossbeams, is potentially dangerous if it is touched. Due the pvc trays are insulating, these situations are not danger, even if there are a bare wire inside, the tray remains secure if you touch it.

Avoids creepage, hot spots and electrical arcs.

Good performance outdoors and to corrosion, over 40 years experience in outdoor installations.

No maintenance.

Basorplast BPE Vs:

	ADVANTAGES	DISADVANTAGES
FiberGlass Cable Tray, Cable Ladder	Cost efficient	Lowest admissible working load
	Equal or better chemical behavior	
	Self extinguising	Greater limitation of working temperatures
	Recyclable	
	Lighter Weight Product for easier installation	
Stainless Steel Cable Tray, Cable Ladder	No grounding or bonding necessary. Maximized Electrical Safety of the installation thanks to insulating PVC	Lowest admissible working load
	Cost efficient	Greater limitation of working temperatures
	Better performance in a saline environment compared to SS304	
Aluminium Cable Tray and Cable Ladder	Major Electrical Safety of the installation, does not have electrical continuity	Lowest admissible working load
	Cost efficient	
	Better behavior against aluminum corrosion in the ladder welds made by not anodized material	Greater limitation of working temperatures

Principales ventajas

Excelente comportamiento ante la corrosión química y los ambientes salinos

Seguridad eléctrica: Material aislante, no requiere toma tierra. Especialmente importante para instalaciones en áreas donde las personas puedan tener acceso. En bandejas metálicas con toma tierra instalada de manera deficiente o en el cruce de dos bandejas, existe un potencial peligro eléctrico si se toca el material. Por el contrario, las bandejas de PVC son aislantes, este tipo de situaciones no son un peligro para el consumidor, incluso habiendo cables pelados en su interior, la bandeja continua siendo segura aunque se toque.

Evita fugas, puntos calientes y arcos eléctricos

Buen comportamiento al exterior y la corrosión, más de 40 años de experiencia en instalaciones al aire libre

Sin mantenimiento

Basorplast BPE Vs:

	VENTAJAS	DESVENTAJAS
Bandejas y escaleras de fibra de vidrio	Más eficiente en coste	Menor carga de trabajo admisible
	Igual o mejor comportamiento ante ambientes químicos	
	Auto-extinguible	Mayor limitación en altas temperaturas de trabajo
	Reciclable	
	Peso del producto permite una instalación más confortable	
Bandejas y escaleras de acero inoxidable	Mayor seguridad eléctrica en la instalación dado que no tiene continuidad eléctrica gracias al PVC aislante	Menor carga de trabajo admisible
	Más eficiente en coste	Mayor limitación en altas temperaturas de trabajo
	De cara a aceros 304, tiene un mejor resultado en ambientes salinos	
Bandejas y escaleras de aluminio	Mayor seguridad eléctrica en la instalación dado que no tiene continuidad eléctrica	Menor carga de trabajo admisible
	Más eficiente en coste	Mayor limitación en altas temperaturas de trabajo
	Mejor comportamiento ante la corrosión del aluminio (No anodizado, 10096 para soldaduras en escalera)	



BASORPLAST

Cutting Corte

- i** Basorplast cable tray is made from a PVC material that can be cut using a standard hand cutting saw with a fine-tooth cutting blade.

Lightly sand any rough surfaces for optimum results.

Las bandejas Basorplast están fabricadas en PVC el cual puede ser cortado con una sierra manual estándar que tenga una hoja de dientes finos.

Lijar las superficies rugosas para obtener resultados óptimos.

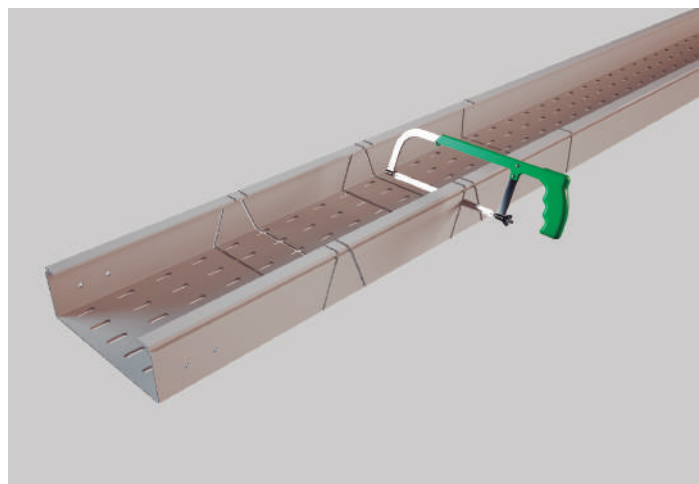
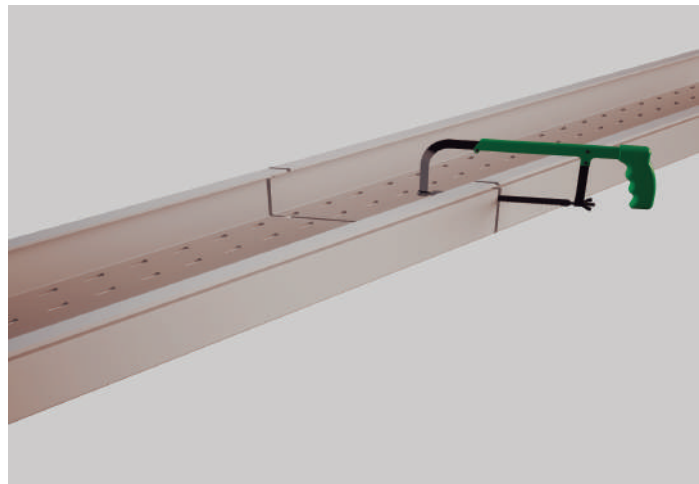
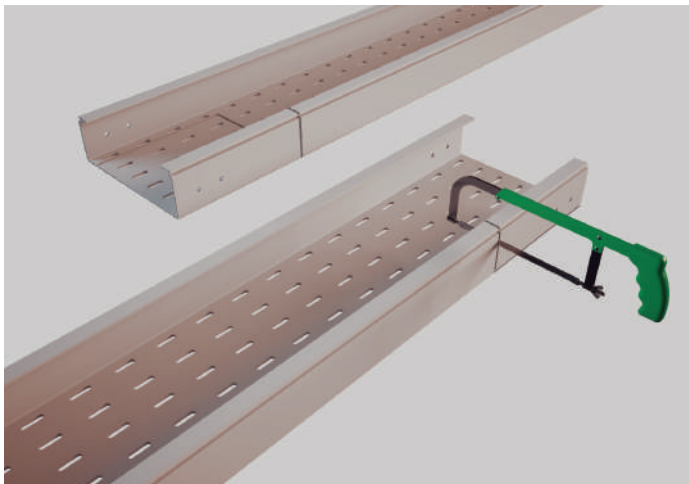
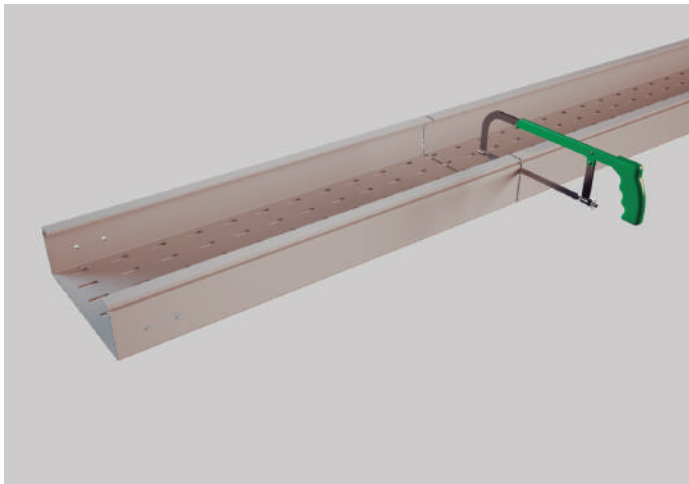

Tools and mounting accessories Herramientas y accesorios de montaje

Mounting accessories / Accesorios de montaje



Screws and nuts:
PVC sets of screws and nuts for all the list of union joints (210017).

Tornillos y tuercas:
Conjuntos de tornillos y tuercas en PVC para todo tipo de juntas de unión (210017).



Standard union joint:
Straight PVC union joint available for high 60 (210084) and high 100 (210085).

Juntas de unión estándar:
Juntas de unión rectas fabricadas en PVC disponibles para altura 60 (210084) y altura 100 (210085).



Vertical union joint:
Articulated PVC union joint available for high 60 (223613) and high 100 (223614).

Junta de unión vertical:
Juntas de unión articuladas fabricadas en PVC, disponibles para altura 60 (223613) y altura 100 (223614).



Horizontal union joint:
Movable PVC union joint available for high 60 (223613) and high 100 (223614).

Junta de unión horizontal:
Juntas de unión curvables fabricadas en PVC para altura 60 (223613) y altura 100 (223614).



PVC derivation Piece:
Angle made of PVC for high 60 (223021) and high 100 (223022).

Pieza de derivación en PVC:
Ángulos fabricados en material PVC para altura 60 (223021) y 100 (223022).

Tools / Herramientas



Electric Drill:
Use an electric drill machine and a borer to drill (of the n°8)

Taladro eléctrico:
Usar un taladro eléctrico y una broca para agujerear (broca del n°8).



Cutting saw:
Use an standard cutting saw for PVC materials.

Sierra de mano:
Usar una sierra manual estándar para corte de plástico.



De-Burr Machine:
Use an small hand re-burr cutter for all materials.

Rebabadora:
Usar una pequeña rebabadora manual para todo tipo de materiales.

Straight Junctions Uniones rectas

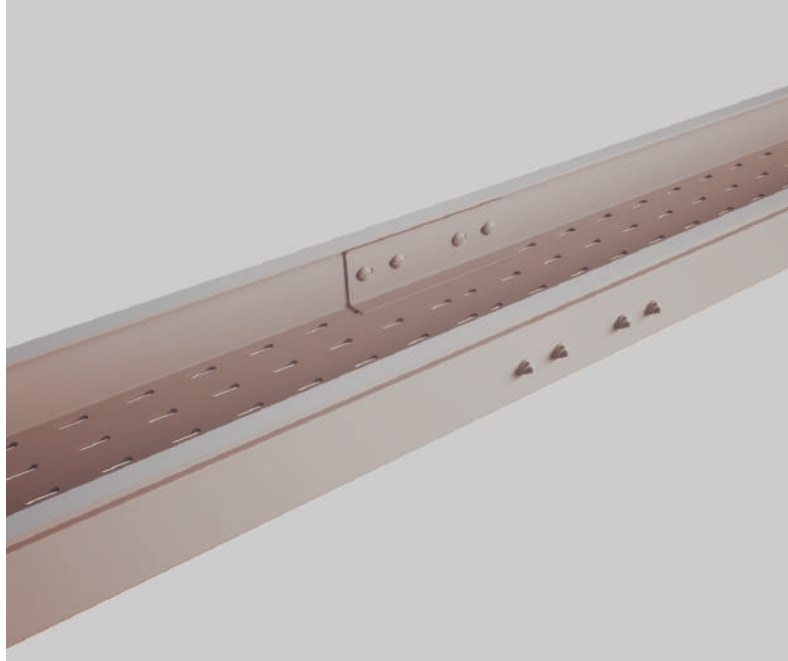
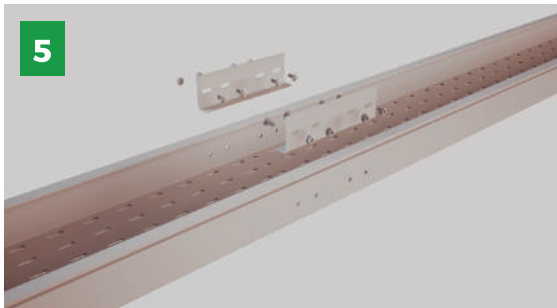
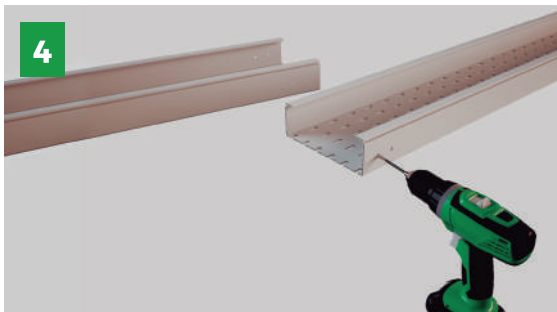
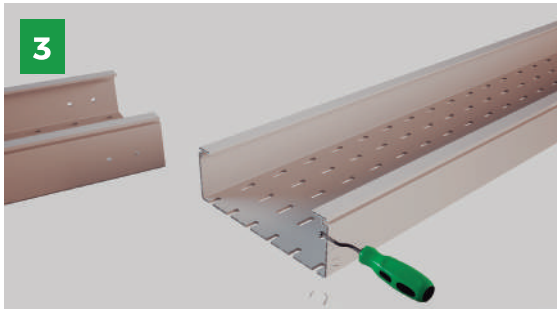
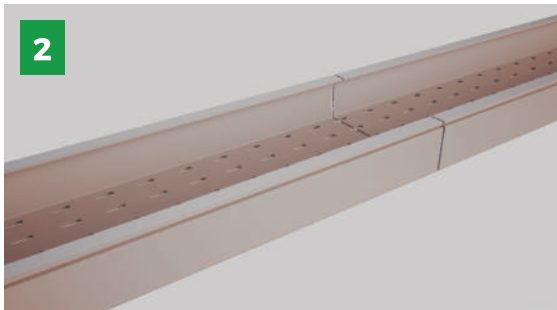
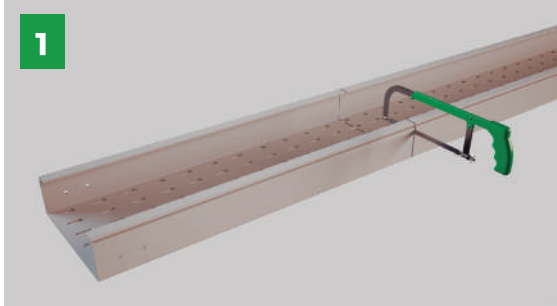

INSTRUCTIONS / INSTRUCCIONES

EN

1. Cut the tray piece with the cutting saw into 2 pieces making a straight cut.
2. Separate the 2 pieces.
3. Remove any rough edges with the de-burring machine.
4. Make 2 holes (for high 60) or 4 holes (for high 100) on each piece with the electric drill.
5. Put 2 union joints JUBPE (210084 for the 60mm height or 210085 for the 100mm) in the correct position and fix the union joints on the tray using 4 screws (for high 60) or 8 screws (for high 100) B2-P (210017).

ES

1. Cortar en dos trozos la bandeja con una sierra de mano mediante un corte recto.
2. Separar las dos piezas.
3. Quitar las superficies rugosas con una rebabadora.
4. Hacer 2 agujeros (para altura 60) o 4 agujeros (para altura 100) en cada pieza con un taladro.
5. Poner 2 juntas de unión JUBPE (código 210084 para altura 60 o código 210085 para altura 100) en la posición correcta y fija cada una de ellas a la bandeja con sus respectivos tornillos y tuercas B2-P (código 210017, 2 unidades para altura 60 o 4 para altura 100).



BASORPLAST



Horizontal Bends / Small Radius Curvas planas / Radio corto

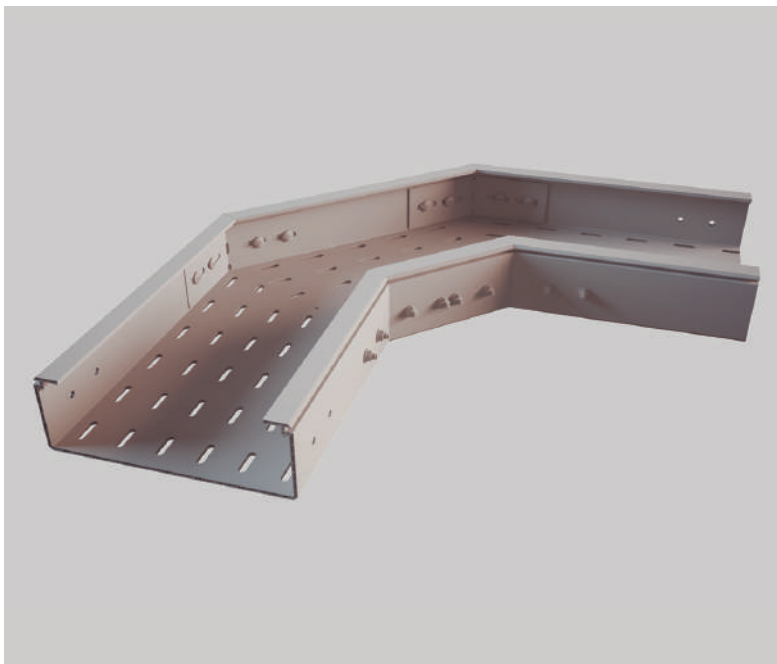
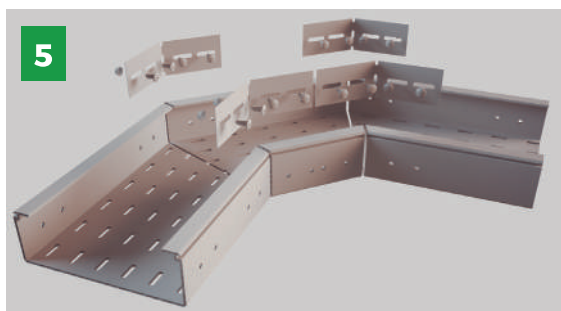
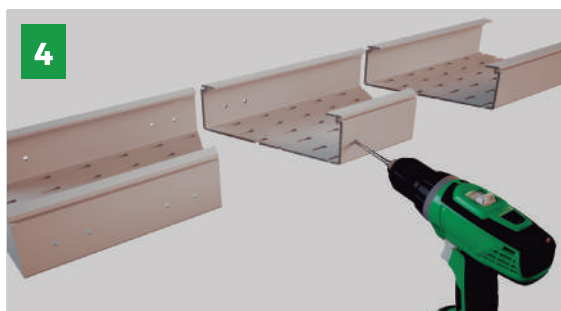
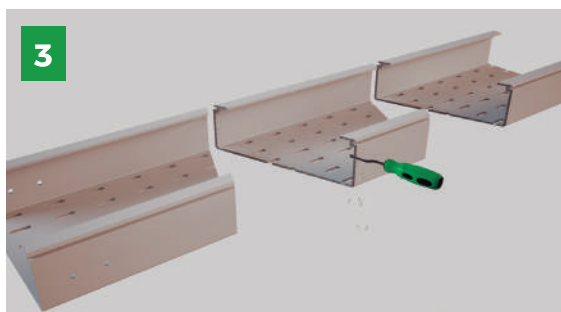
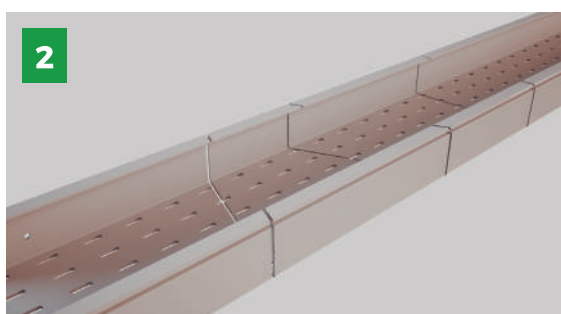

INSTRUCTIONS / INSTRUCCIONES

EN

1. Cut the tray piece with the cutting saw in 3 pieces making a 45° cut.
2. Separate the 3 pieces.
3. Remove any rough edges with the de-burring machine.
4. Make 8 holes on each piece with the electric drill.
5. Put 4 union joints JUBPE-B (223613 for the 60mm height or 223614 for the 100mm) in the correct position and fix the union joints on the tray using 16 screws B2-P (210017).

ES

1. Cortar la bandeja en tres trozos a 45° con una sierra de mano.
2. Separar las tres piezas.
3. Quitar las superficies rugosas con una rebabadora .
4. Hacer 8 agujeros en cada pieza con un taladro eléctrico.
5. Poner 4 juntas de unión JUBPE-B (223613 para altura 60 o 223614 para altura 100) en la posición correcta y fija cada una de ellas a la bandeja con 4 tornillos y 4 tuercas B2-P (210017), usando en total 16 tornillos y 16 tuercas.





BASORPLAST

Horizontal Bends / Right Radius Curvas planas / Radio recto

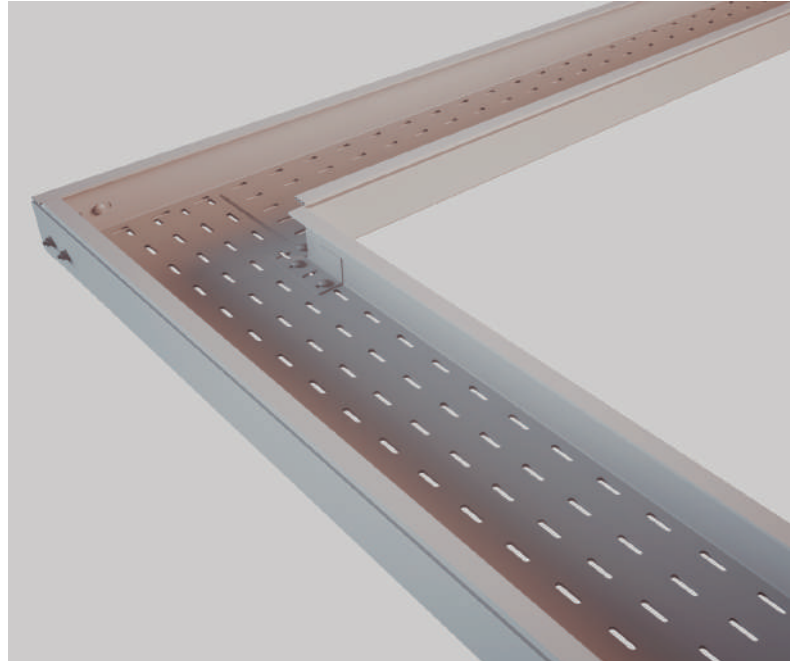
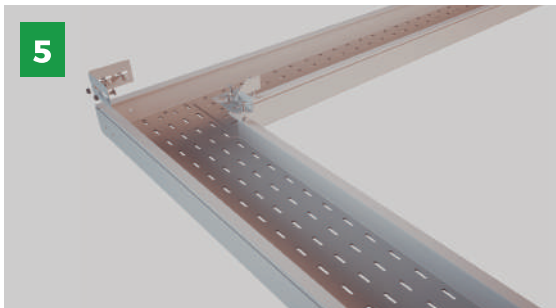
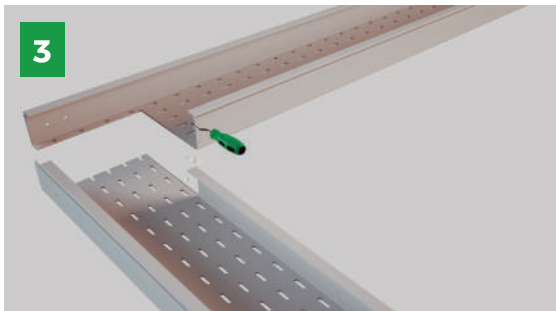
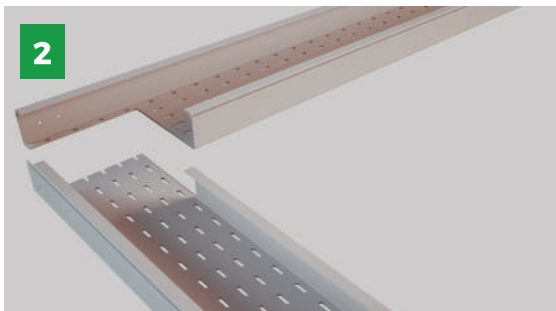
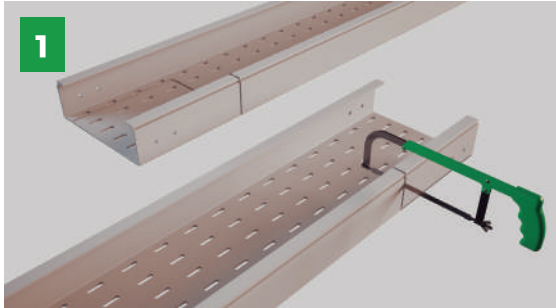

INSTRUCTIONS / INSTRUCCIONES

EN

1. Cut the tray piece 1 removing the base and cut the tray piece 2 removing the side body, both with the cutting saw.
2. Separate the 2 pieces.
3. Remove any rough edges with the de-burring machine.
4. Make 4 holes on each piece with the electric drill.
5. Put 1 union joint JUBPE-B (223613 for the 60mm height or 223614 for the 100mm) and 1 PDBPE (223021 for the 60mm height or 223022 for the 100mm height) in the correct position and fix the union joints on the tray using 8 screws B2-P (210017).

ES

1. Cortar la bandeja número 1 quitando la base, corta la bandeja número 2 quitando el ala, ambas dos con una sierra de mano.
2. Separar las dos piezas.
3. Quitar las superficies rugosas con una rebabadora.
4. Hacer 4 agujeros en cada pieza con un taladro eléctrico.
5. Poner 1 junta de unión JUBPE-B (223613 para altura 60 o 223614 para altura 100) y 1 pieza de derivación PDBPE (223021 para altura 60 o 223022 para altura 100) en la posición correcta, fija cada una de ellas a la bandeja con 4 tornillos y 4 tuercas B2-P (210017), usando en total 8 tornillos y 8 tuercas.





BASORPLAST



Horizontal Bends / Large Radius Curvas planas / Radio largo

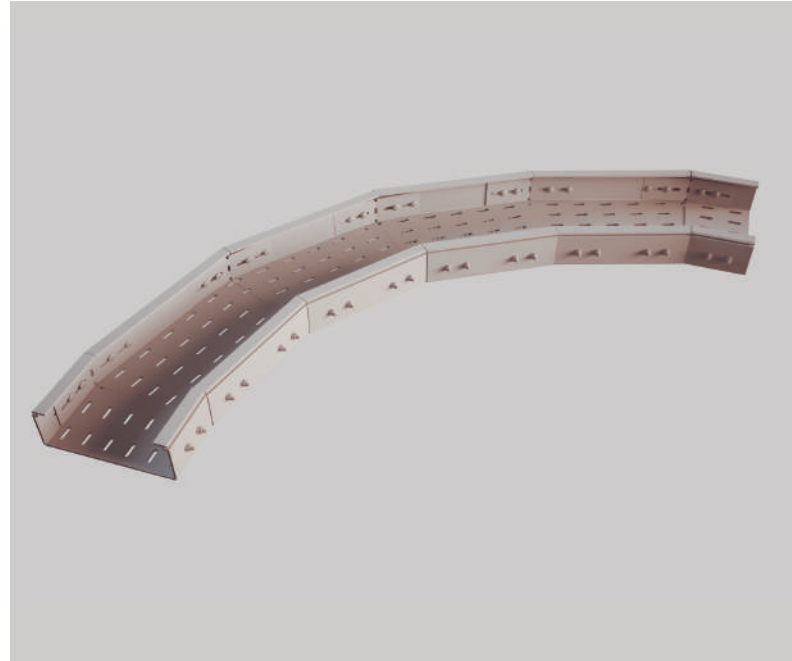
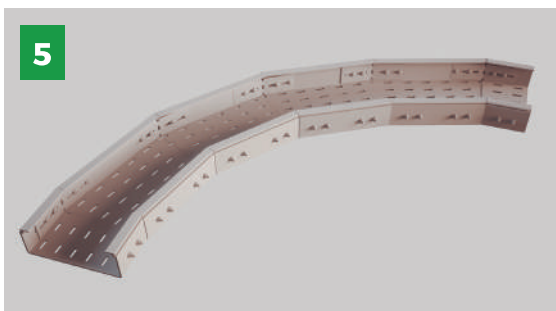
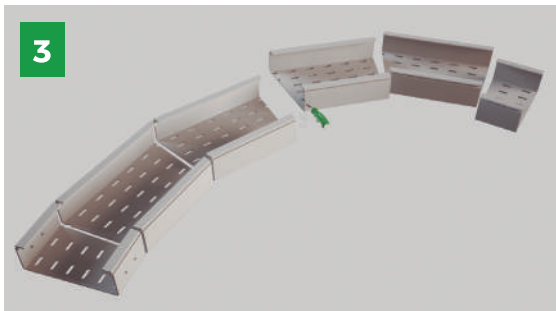
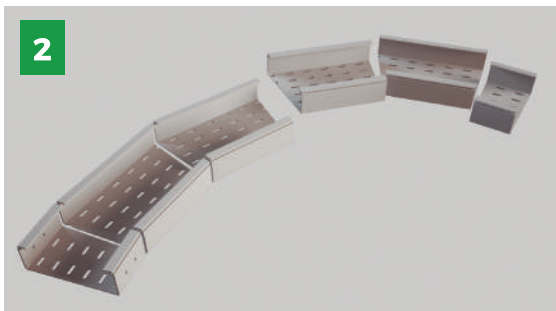
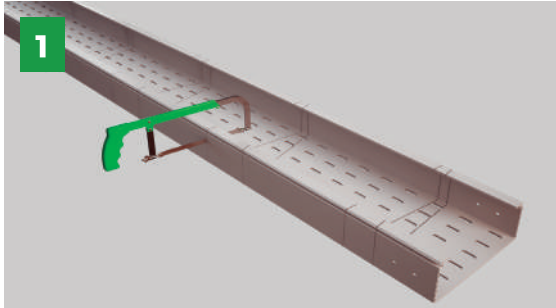

INSTRUCTIONS / INSTRUCCIONES

EN

1. Cut the tray piece with the cutting saw in 6 pieces making a 45° cut.
2. Separate the 6 pieces.
3. Remove any rough edges with the de-burring machine.
4. Make 4 holes on each piece with the electric drill.
5. Put 10 union joints JUBPE-B (223613 for the 60mm or 223614 for the 100mm) in the correct position and fix the union joints on the tray using 40 screws B2-P (210017).

ES

1. Cortar la bandeja en seis trozos a 45° con una sierra de mano.
2. Separar las seis piezas.
3. Quitar las superficies rugosas con una rebabadora.
4. Hacer 4 agujeros en cada pieza con un taladro eléctrico.
5. Poner 10 juntas de unión JUBPE-B (223613 para altura 60 o 223614 para altura 100) en la posición correcta, fija cada una de ellas a la bandeja con 4 tornillos y 4 tuercas B2-P (210017), usando en total 40 tornillos y 40 tuercas.





BASORPLAST

Horizontal Bends / Other Radius Curvas planas / Otros radios

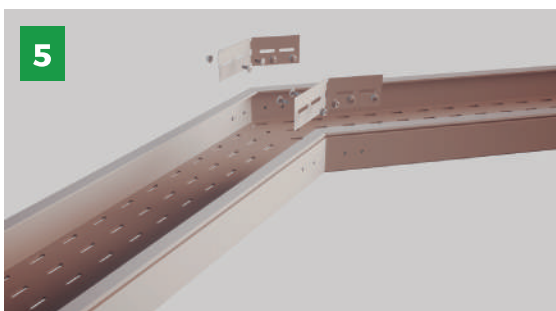
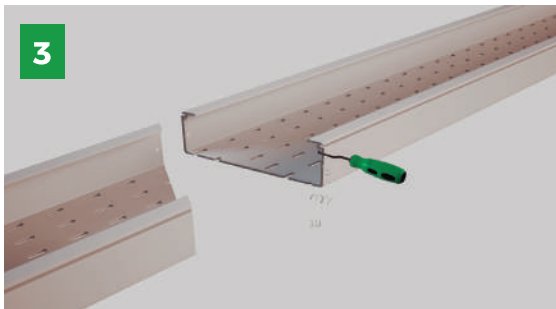
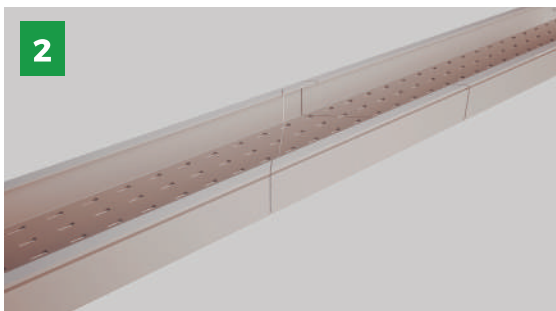
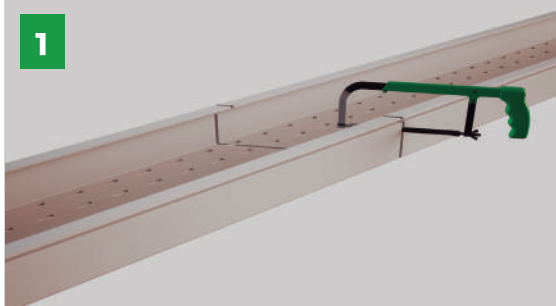

INSTRUCTIONS / INSTRUCCIONES

EN

1. Cut the tray piece with the cutting saw in 2 pieces making a 45° cut.
2. Separate the 2 pieces.
3. Remove any rough edges with the de-burring machine.
4. Make 4 holes on each piece with the electric drill.
5. Put 2 union joints JUBPE-B (223613 for the 60mm or 223614 for the 100mm) in the correct position and fix the union joints on the tray using 8 screws B2-P (210017).

ES

1. Cortar la bandeja en dos trozos a 45° con una sierra de mano.
2. Separar las dos piezas.
3. Quitar las superficies rugosas con una rebabadora .
4. Hacer 4 agujeros en cada pieza con un taladro eléctrico.
5. Poner 2 juntas de unión JUBPE-B (223613 para altura 60 o 223614 para altura 100) en la posición correcta, fija cada una de ellas a la bandeja con 4 tornillos y 4 tuercas B2-P (210017), usando en total 8 tornillos y 8 tuercas.





BASORPLAST



Inside Bends / Small radius Curvas cóncavas / Radio corto

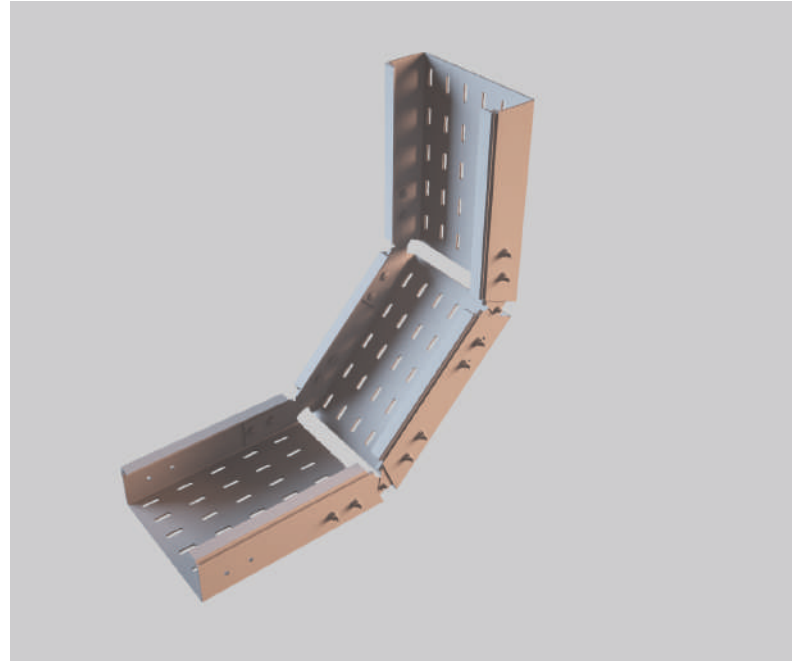
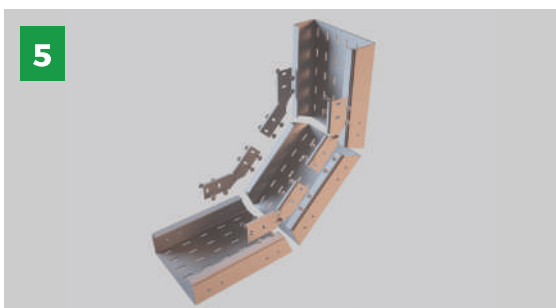
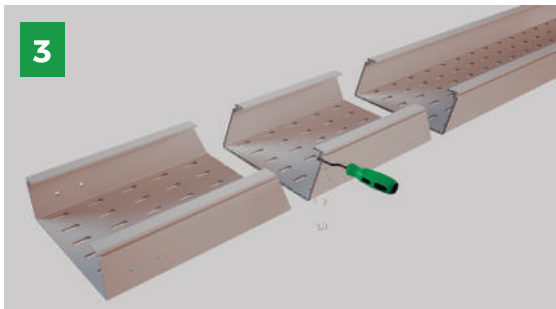
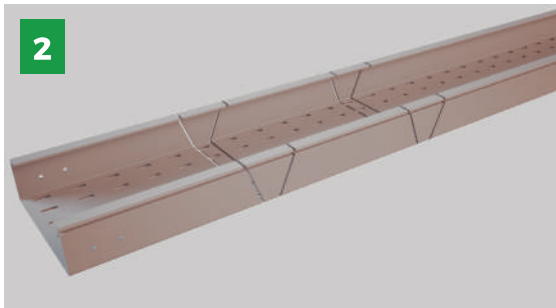
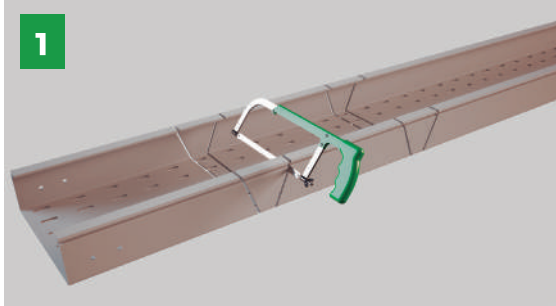

INSTRUCTIONS / INSTRUCCIONES

EN

1. Cut the tray piece with the cutting saw in 3 pieces making a 45° angle cut.
2. Separate the 3 pieces.
3. Remove any rough edges with the de-burring machine.
4. Make 4 holes on each piece with the electric drill.
5. Put 4 union joints JUBPE-A (223613 for the 60mm or 223614 for the 100mm) in the correct position and fix the union joints on the tray using 16 screws B2-P (210017).

ES

1. Cortar la bandeja inclinada en tres trozos a 45° con una sierra de mano.
2. Separar las tres piezas.
3. Quitar las superficies rugosas con una rebabadora .
4. Hacer 4 agujeros en cada pieza con un taladro eléctrico.
5. Poner 4 juntas de unión JUBPE-A (223613 para altura 60 o 223614 para altura 100) en la posición correcta, fija cada una de ellas a la bandeja con 4 tornillos y 4 tuercas B2-P (210017), usando en total 16 tornillos y 16 tuercas.





BASORPLAST

Inside Bends / Right radius Curvas cóncavas / Radio recto

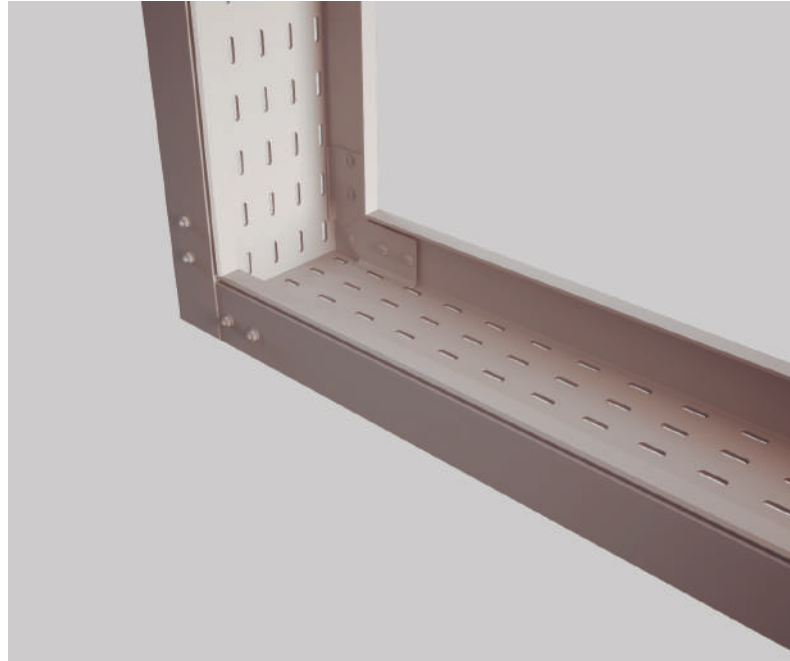
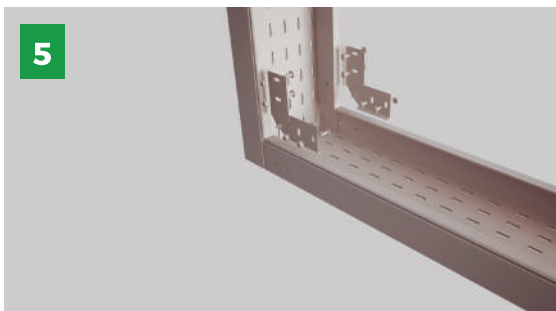
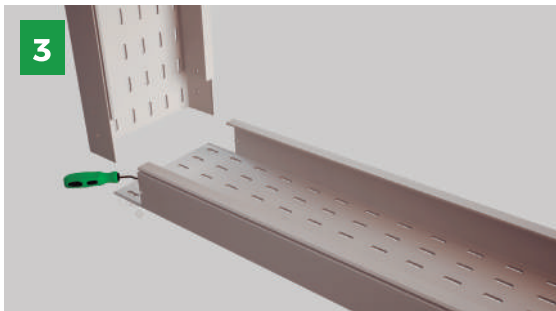
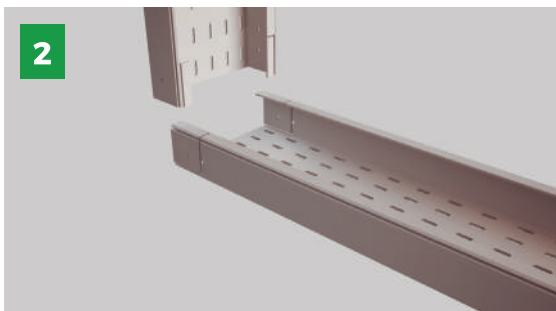
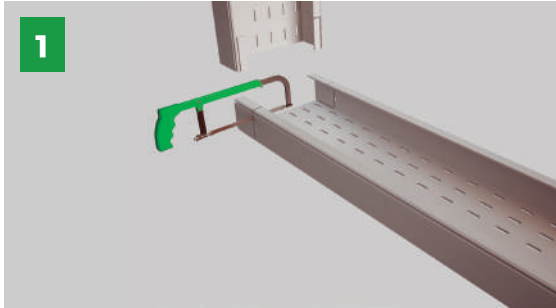

INSTRUCTIONS / INSTRUCCIONES

EN

1. Cut the tray piece 1 removing the top side body and cut the tray piece 2 removing the side body, both with the cutting saw.
2. Separate the 2 pieces.
3. Remove any rough edges with the de-burring machine.
4. Make 4 holes on each piece with the electric drill.
5. Put 2 union joints JUBPE-A (223613 for the 60mm or 223614 for the 100mm) in the correct position and fix the union joints on the tray using 8 screws B2-P (210017).

ES

1. Cortar la bandeja número 1 quitando el ala superior, corta la bandeja número 2 quitando el ala lateral, ambas dos con una sierra de mano.
2. Separar las dos piezas.
3. Quitar las superficies rugosas con una rebabadora.
4. Hacer 4 agujeros en cada pieza con un taladro eléctrico.
5. Poner 2 juntas de unión JUBPE-A (223613 para altura 60 o 223614 para altura 100) en la posición correcta, fija cada una de ellas a la bandeja con 4 tornillos y 4 tuercas B2-P (210017), usando en total 8 tornillos y 8 tuercas.





BASORPLAST



Inside Bends / Large radius Curvas cóncavas / Radio largo

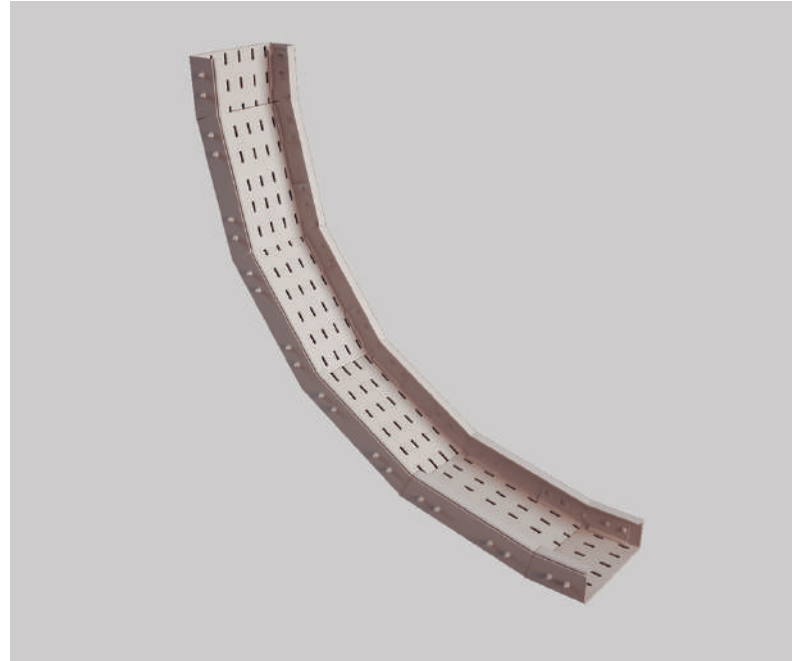
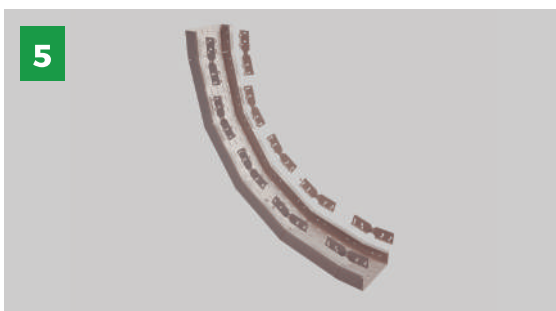
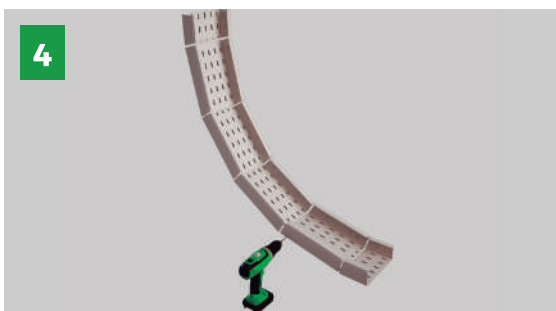
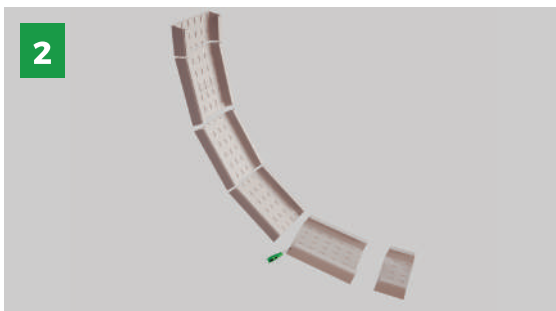
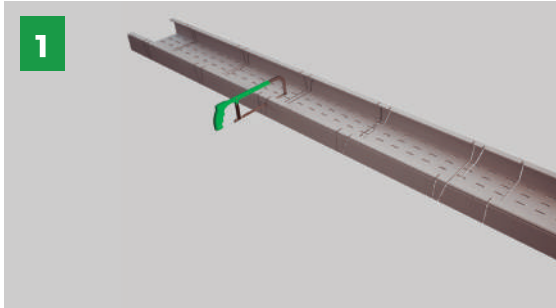

INSTRUCTIONS / INSTRUCCIONES

EN

1. Cut the tray piece with the cutting saw in 6 pieces making a 45° angle cut.
2. Separate the 6 pieces.
3. Remove any rough edges with the de-burring machine.
4. Make 4 holes on each piece with the electric drill.
5. Put 10 union joints JUBPE-A (223613 for the 60mm or 223614 for the 100mm) in the correct position and fix the union joints on the tray using 40 screws B2-P (210017).

ES

1. Cortar la bandeja inclinada en seis trozos a 45° con una sierra de mano.
2. Separar las seis piezas.
3. Quitar las superficies rugosas con una rebabadora .
4. Hacer 4 agujeros en cada pieza con un taladro eléctrico.
5. Poner 10 juntas de unión JUBPE-A (223613 para altura 60 o 223614 para altura 100) en la posición correcta, fija cada una de ellas a la bandeja con 4 tornillos y 4 tuercas B2-P (210017), usando en total 40 tornillos y 40 tuercas.



Outside Bends / Small radius Curvas convexas / Radio corto

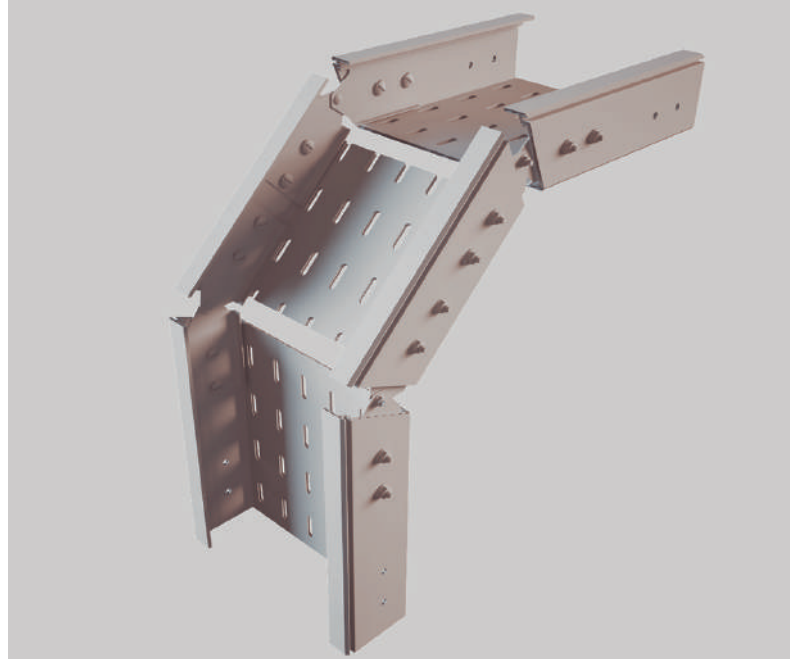
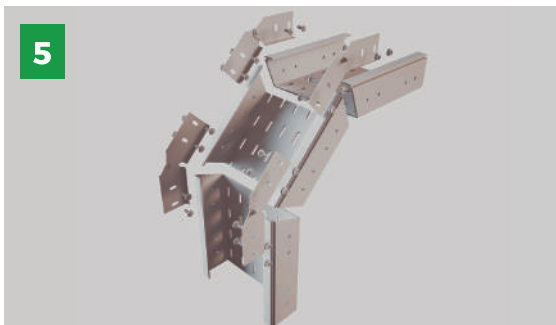
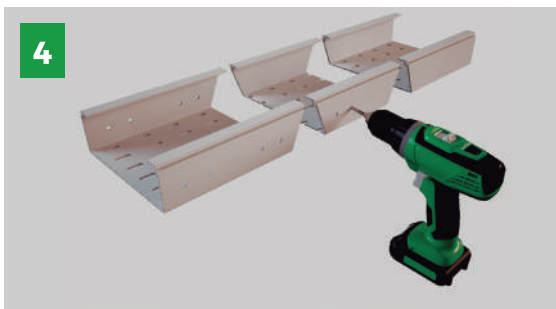
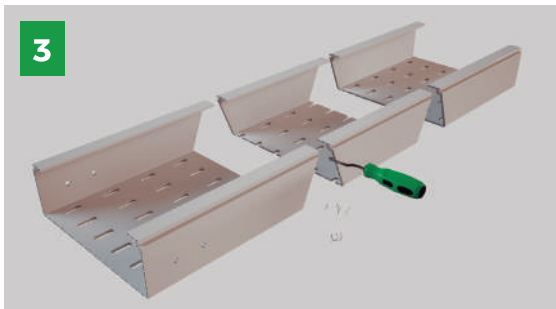
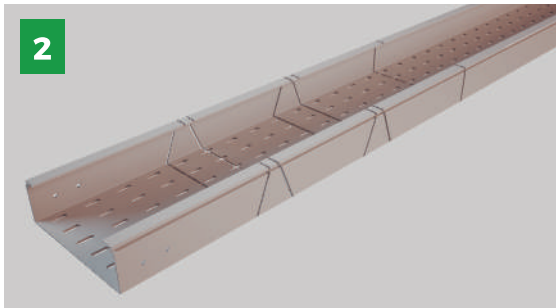
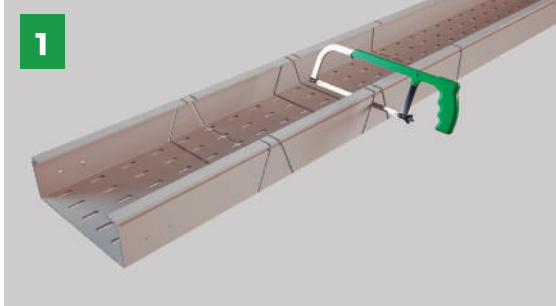

INSTRUCTIONS / INSTRUCCIONES

EN

1. Cut the tray piece with the cutting saw in 3 pieces making a 45° angle cut.
2. Separate the 3 pieces.
3. Remove any rough edges with the de-burring machine.
4. Make 4 holes on each piece with the electric drill.
5. Put 4 union joints JUBPE-A (223613 for the 60mm or 223614 for the 100mm) in the correct position and fix the union joints on the tray using 16 screws B2-P (210017).

ES

1. Cortar la bandeja inclinada en 3 trozos a 45° con una sierra de mano.
2. Separar las 3 piezas.
3. Quitar las superficies rugosas con una rebabadora.
4. Hacer 4 agujeros en cada pieza con un taladro eléctrico.
5. Poner 4 juntas de unión JUBPE-A (223613 para altura 60 o 223614 para altura 100) en la posición correcta, fija cada una de ellas a la bandeja con 4 tornillos y 4 tuercas B2-P (210017), usando en total 16 tornillos y 16 tuercas.



BASORPLAST



Outside Bends / Right radius Curvas convexas / Radio recto

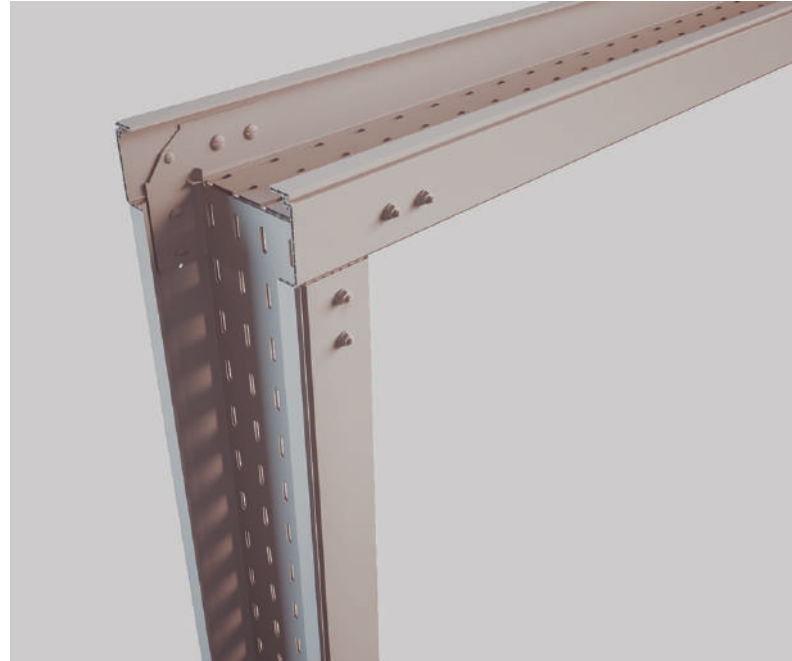
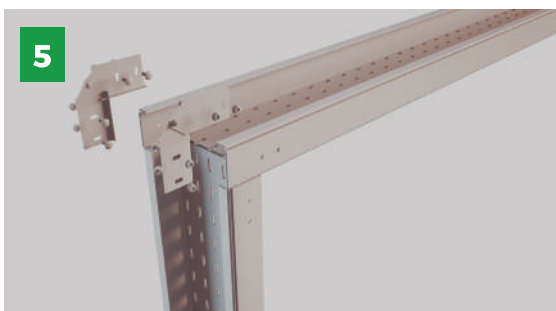
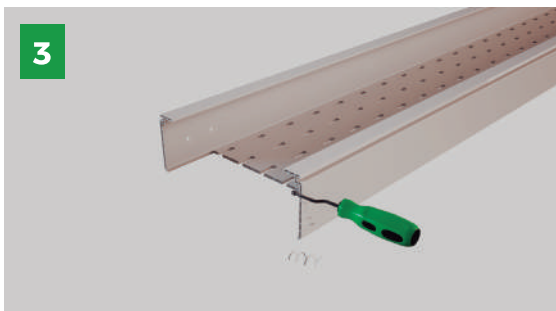
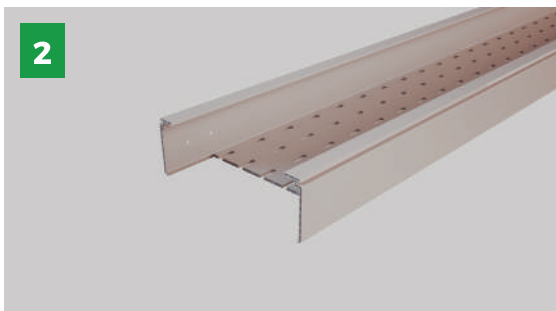
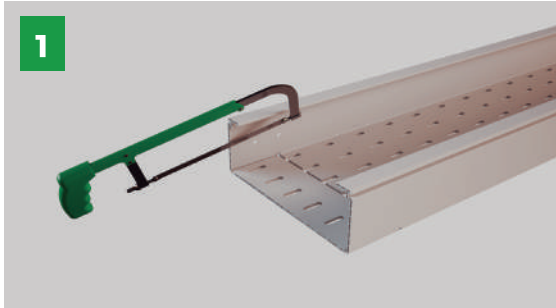

INSTRUCTIONS / INSTRUCCIONES

EN

1. Cut the tray piece removing the base with the cutting saw.
2. Separate the pieces.
3. Remove any rough edges with the de-burring machine.
4. Make 4 holes on the piece with the electric drill.
5. Put 2 union joints JUBPE-B (223613 for the 60mm or 223614 for the 100mm) in the correct position and fix the union joints on the tray using 8 screws B2-P (210017).

ES

1. Cortar la bandeja quitando la base con una sierra de mano.
2. Separar las dos piezas
3. Quitar las superficies rugosas con una rebabadora .
4. Hacer 4 agujeros en cada pieza con un taladro eléctrico.
5. Poner 2 juntas de unión JUBPE-B (223613 para altura 60 o 223614 para altura 100) en la posición correcta, fija cada una de ellas a la bandeja con 4 tornillos y 4 tuercas B2-P (210017), usando en total 8 tornillos y 8 tuercas.





BASORPLAST

Outside Bends / Large radius Curvas convexas / Radio largo

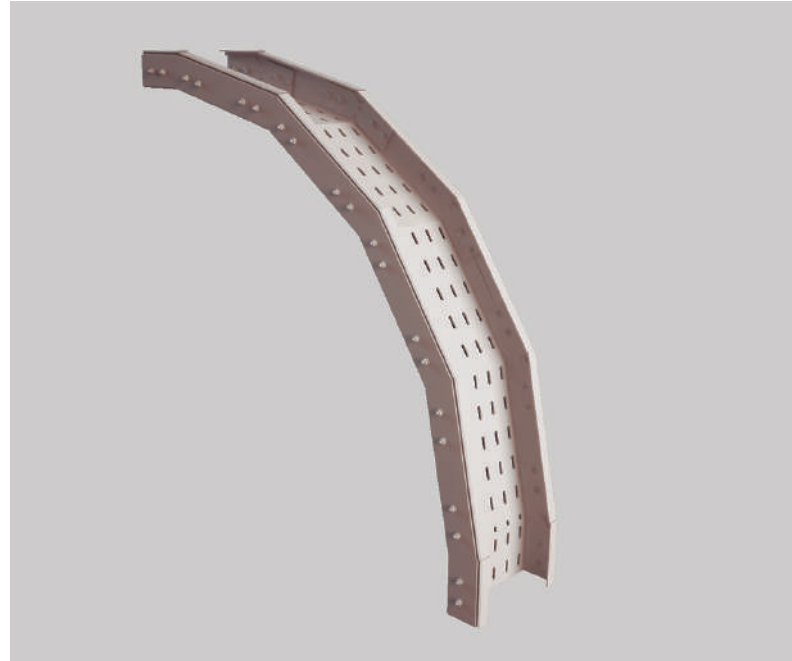
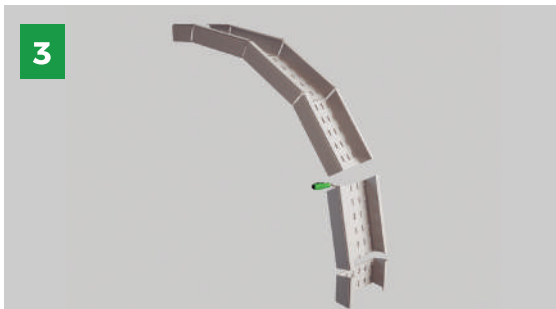
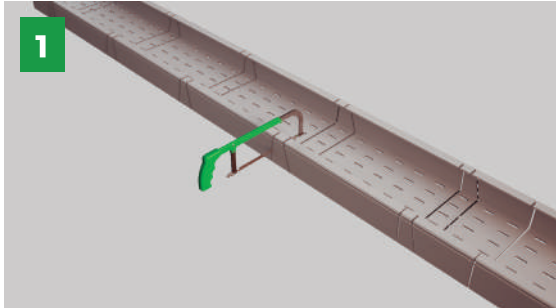

INSTRUCTIONS / INSTRUCCIONES

EN

1. Cut the tray piece with the cutting saw in 6 pieces making a 45° angle cut.
2. Separate the 6 pieces.
3. Remove any rough edges with the de-burring machine.
4. Make 4 holes on each piece with the electric drill.
5. Put 10 union joints JUBPE-A (223613 for the 60mm or 223614 for the 100mm) in the correct position and fix the union joints on the tray using 40 screws B2-P (210017).

ES

1. Cortar la bandeja inclinada en 6 trozos a 45° con una sierra de mano.
2. Separar las 6 piezas.
3. Quitar las superficies rugosas con una rebabadora.
4. Hacer 4 agujeros en cada pieza con un taladro eléctrico.
5. Poner 10 juntas de unión JUBPE-A (223613 para altura 60 o 223614 para altura 100) en la posición correcta, fija cada una de ellas a la bandeja con 4 tornillos y 4 tuercas B2-P (210017), usando en total 40 tornillos y 40 tuercas.





BASORPLAST



Tee Bends Tés

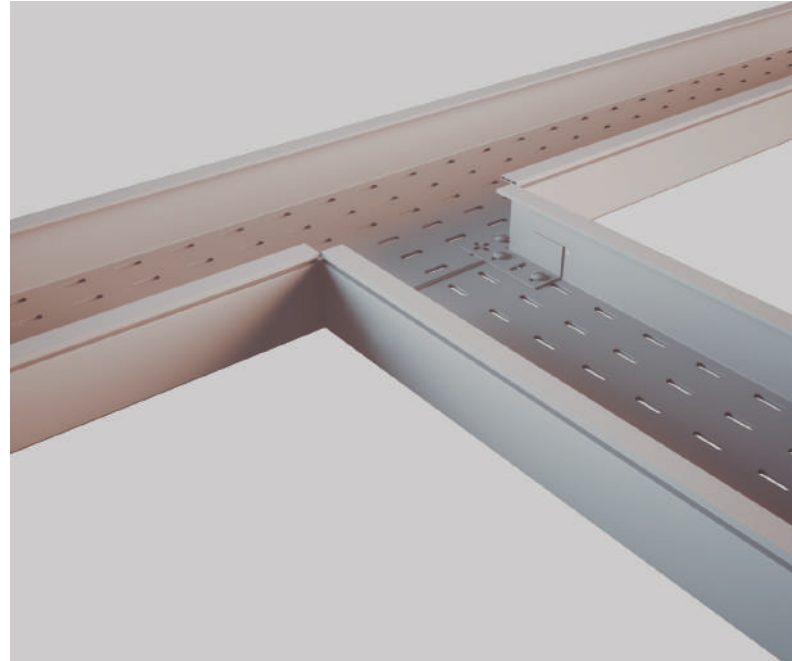
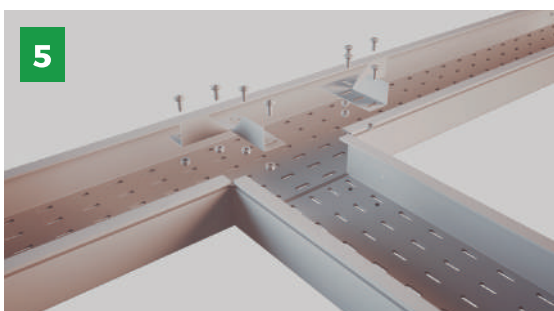
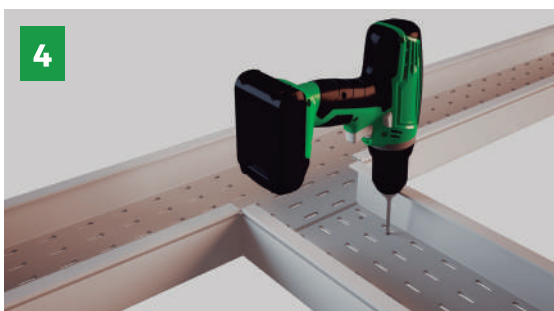
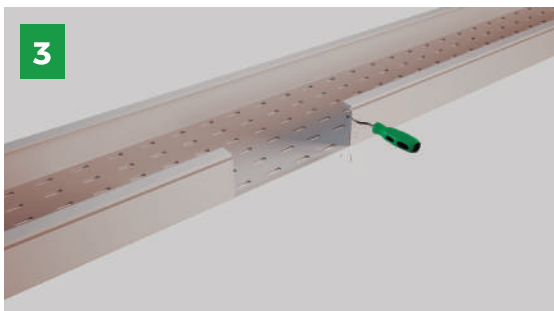
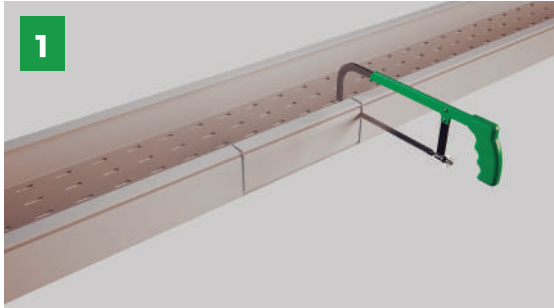

INSTRUCTIONS / INSTRUCCIONES

EN

1. Cut the tray piece removing the side body with the cutting saw.
2. Separate the 2 pieces.
3. Remove any rough edges with the de-burring machine.
4. Make 4 holes on the piece with the electric drill.
5. Put 2 derivation pieces PDBPE (223021 for high 60mm or 223022 for high 100mm) in the correct position and fix it on the tray using 8 screws B2-P (210017).

ES

1. Cortar la bandeja quitando un ala con una sierra de mano.
2. Separar las 2 piezas.
3. Quitar las superficies rugosas con una rebabadora
4. Hacer 4 agujeros en cada pieza con un taladro eléctrico.
5. Poner 2 juntas de derivación PDBPE (223021 para altura 60mm o 223022 para altura 100mm) en la posición correcta, fija cada una de ellas a la bandeja con 8 tornillos y 8 tuercas B2-P (210017).





BASORPLAST

Cross Bends Cruces

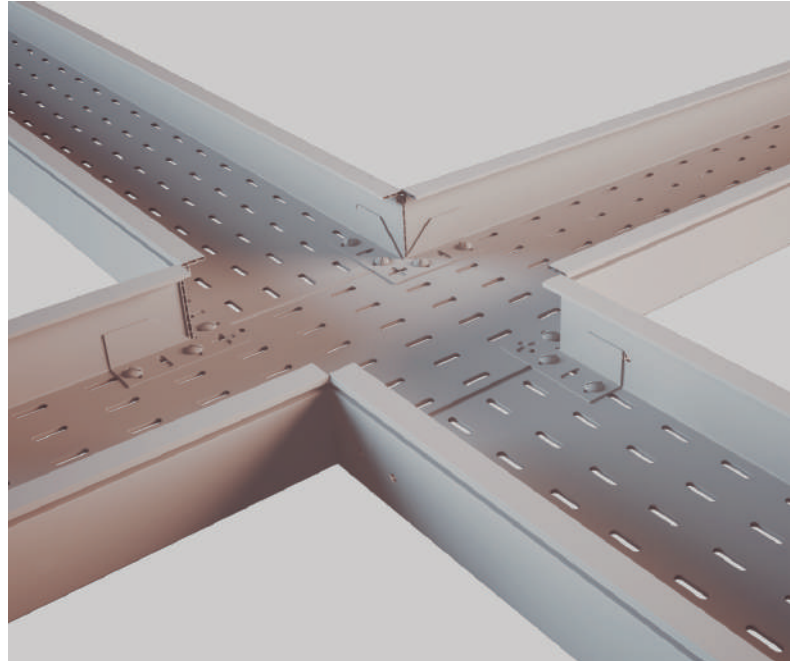
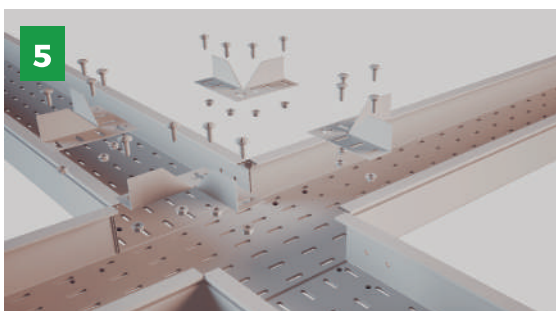
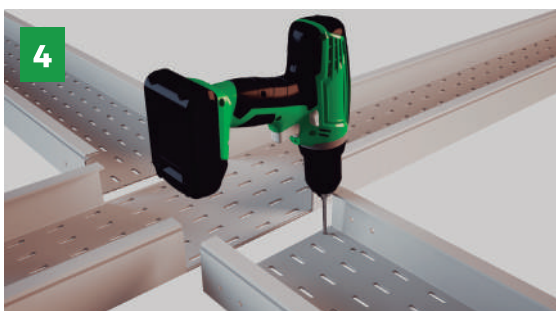
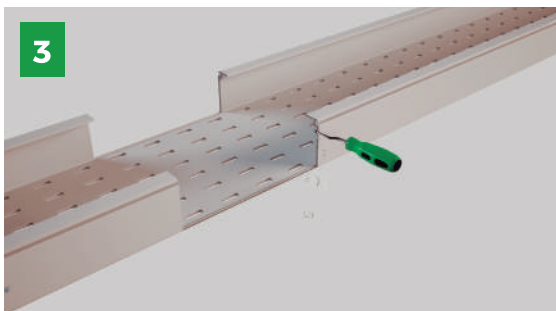
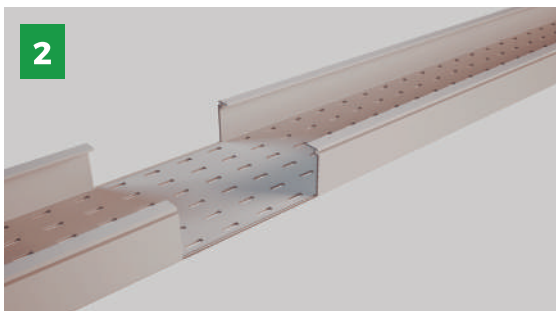
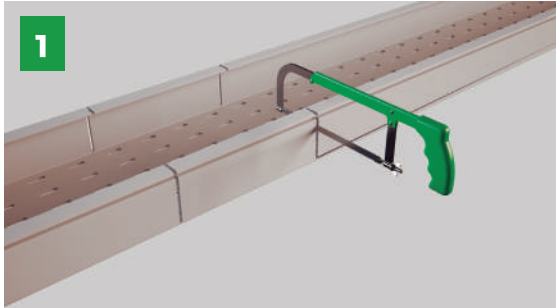

INSTRUCTIONS / INSTRUCCIONES

EN

1. Cut the tray piece removing the 2 side body with the cutting saw.
2. Separate the 2 piece.
3. Remove any rough edges with the de-burring machine.
4. Make 4 holes on the piece with the electric drill.
5. Put 4 derivation pieces PDBPE (223021 for high 60mm or 223022 for high 100mm) in the correct position and fix it on the tray using 16 screws B2-P (210017).

ES

1. Cortar la bandeja quitando las dos alas con una sierra de mano.
2. Separar las piezas.
3. Quitar las superficies rugosas con una rebabadora .
4. Hacer 4 agujeros en cada pieza con un taladro eléctrico.
5. Poner 4 juntas de derivación PDBPE (223021 para altura 60mm o 223022 para altura 100mm) en la posición correcta, fija cada una de ellas a la bandeja con 16 tornillos y 16 tuercas B2-P (210017).





BASORPLAST



Elevation Changes Cambios de nivel

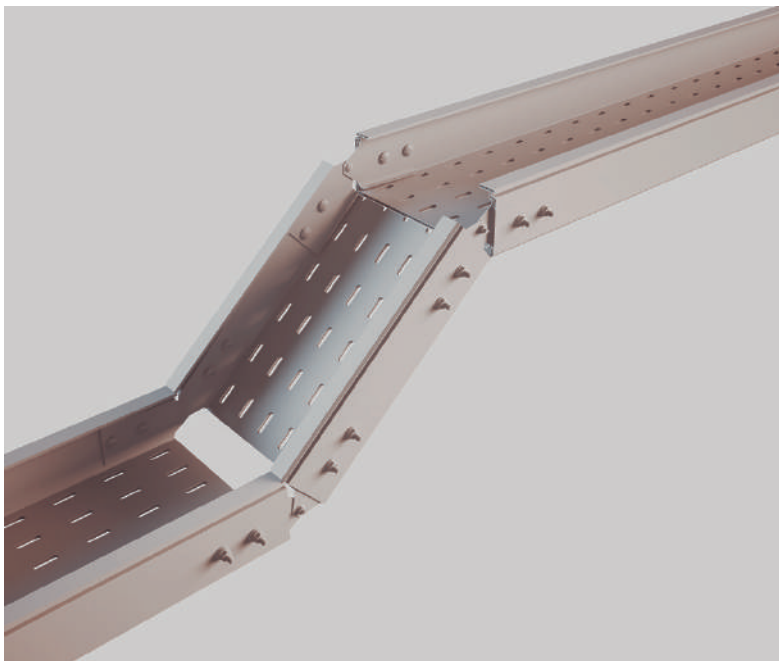
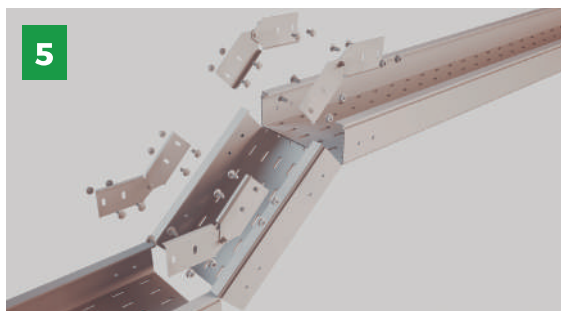
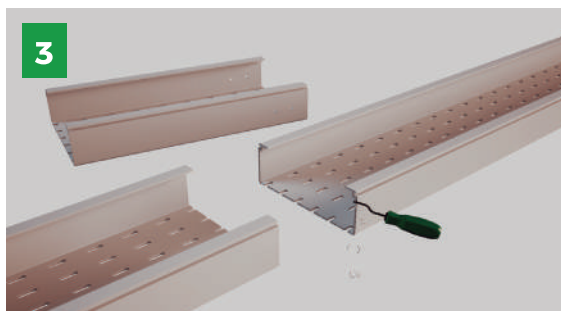
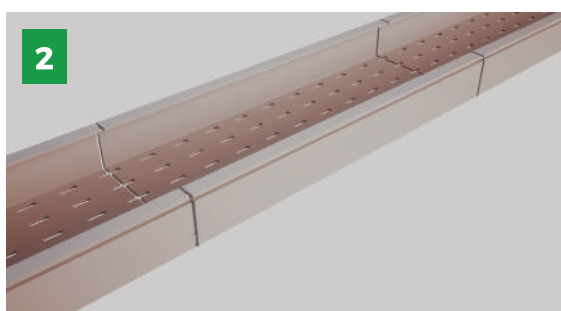

INSTRUCTIONS / INSTRUCCIONES

EN

1. Cut the tray piece with a cutting saw in 3 pieces making a straight cut.
2. Separate the 3 pieces.
3. Remove any rough edges with the de-burring machine.
4. Make 8 holes on each piece with the electric drill.
5. Put 4 union joints JUBPE-A (223613 for the 60mm or 223614 for the 100mm) in the correct position and fix the union joints on the tray using 16 screws B2-P (210017).

ES

1. Cortar en 3 trozos la bandeja con una sierra de mano mediante un corte recto.
2. Separar las 3 piezas.
3. Quitar las superficies rugosas con una rebabadora .
4. Hacer 8 agujeros en cada pieza con un taladro eléctrico.
5. Poner 4 juntas de unión JUBPE-A (223613 para altura 60 o 223614 para altura 100) en la posición correcta, fija cada una de ellas a la bandeja con 16 tornillos y 16 tuercas B2-P (210017).





BASORPLAST

Application on strut / Solid bottom Aplicación en perfil / Ciega

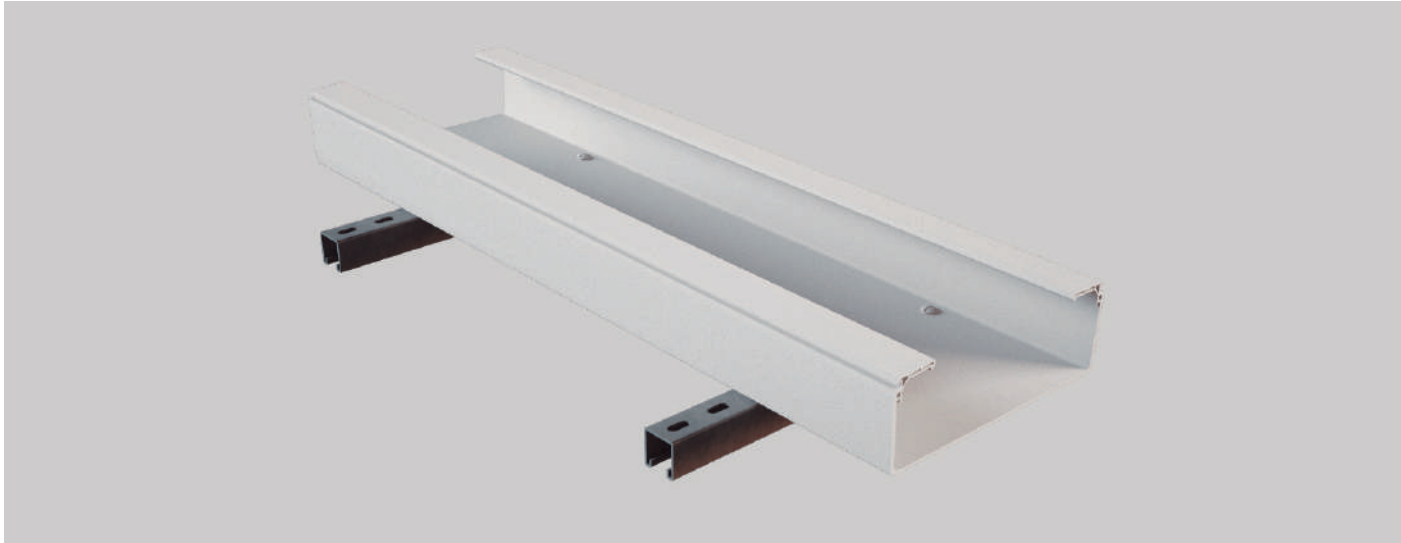

INSTRUCTIONS / INSTRUCCIONES

EN

1. Put the strut on the base of the tray and mark the holes.
2. Make 4 holes on the tray with the electric drill.
3. Fix the strut on the tray using 4 screws B2-P (210017).

ES

1. Poner el perfil en la base de la bandeja y marca los huecos.
2. Hacer 4 agujeros en la bandeja con un taladro.
3. Fijar cada una de ellos a la bandeja con 4 tornillos y 4 tuercas B2-P (210017).





BASORPLAST



Application on strut / Slotted Aplicación en perfil / Perforadas

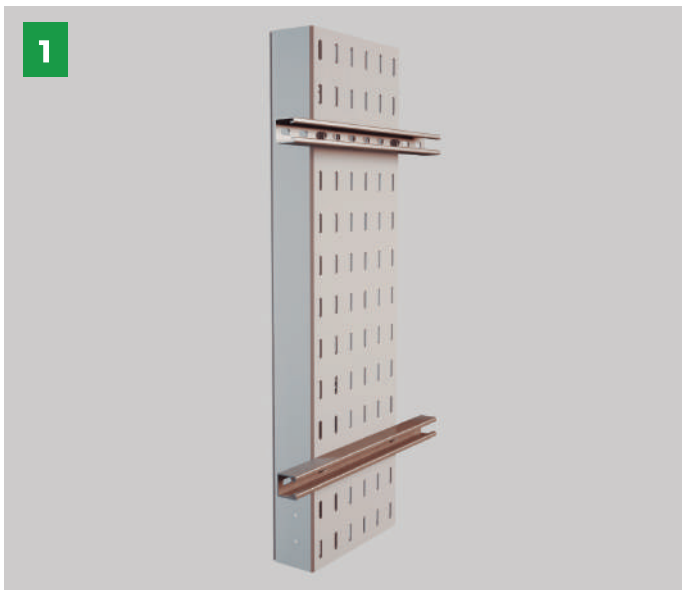
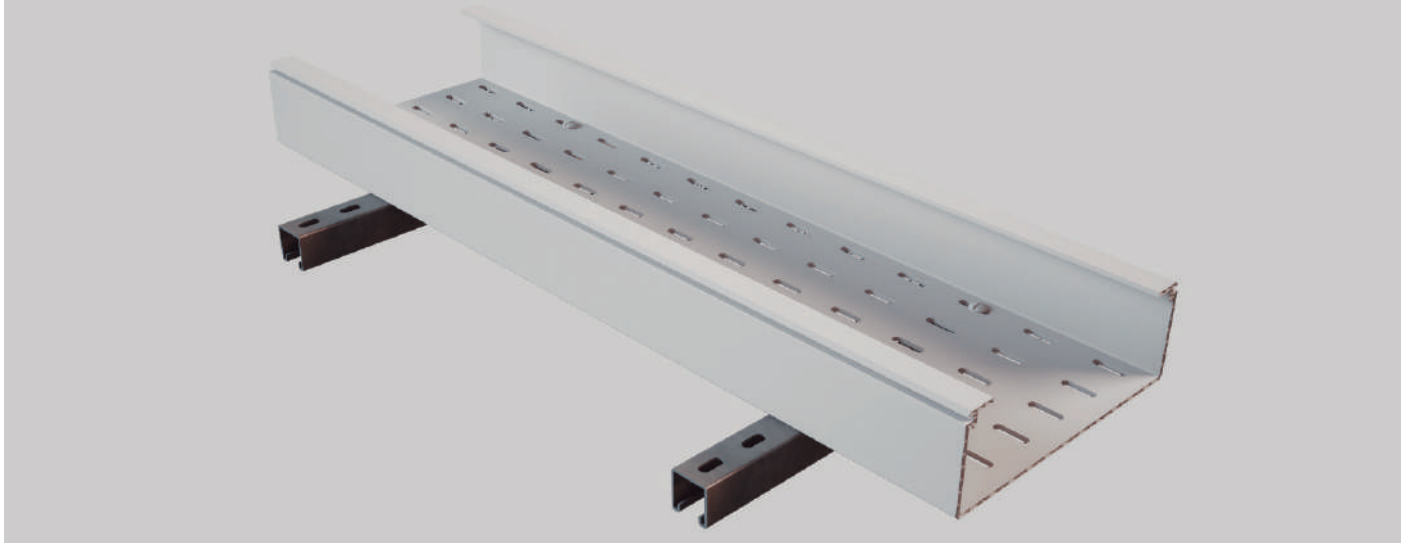

INSTRUCTIONS / INSTRUCCIONES

EN

1. Put the strut on the base of the tray.
2. Fix the strut on the tray using 4 screws B2-P (210017).

ES

1. Poner el perfil en la base de la bandeja.
2. Fijar cada una de ellos a la bandeja con 4 tornillos y 4 tuercas B2-P (210017).

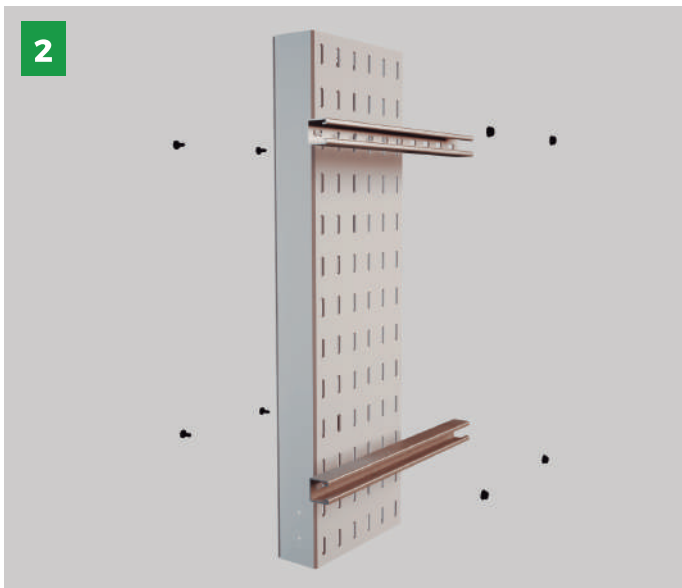



BASORPLAST

3E Basor

CABLE TRAY SPECIALIST



IEC 61537
EN 50085



IEC 61537
EN 50085
UNE 23727
UL94



EN 60695



IEC 61537



IEC 50085

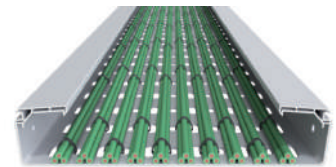
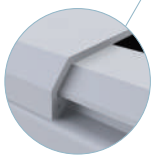

Mod. 60x100 10J
IEC 61537
EN 50085



IEC 60529



IEC 50102



ISO/TR 10358
DIN 8061



TBPE



CPBPE



TCPBPE



CCBPE



TCCBPE



CXBPE



TCXBPE



PDBPE



TFBPE



PSBPE



JUBPE



JUBPE-A



JUBPE-B



CTBP



BASORPLAST



BASORPLAST BPE-P / H60



3m (10ft)	↓↑		↔		PVC UVM1
	mm	inch	mm	inch	
BPE 60X100	60	2 3/8"	100	4"	210070
BPE 60X150	60	2 3/8"	150	6"	210071
BPE 60X200	60	2 3/8"	200	8"	210072
BPE 60X300	60	2 3/8"	300	12"	210073

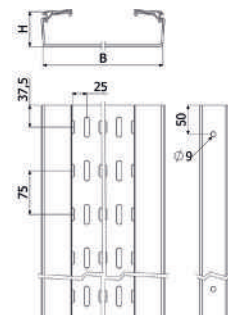

BASORPLAST BPE-C / H60



3m (10ft)	↓↑		↔		PVC UVM1
	mm	inch	mm	inch	
BPE-C 60X100	60	2 3/8"	100	4"	210062
BPE-C 60X150	60	2 3/8"	150	6"	210063
BPE-C 60X200	60	2 3/8"	200	8"	210064
BPE-C 60X300	60	2 3/8"	300	12"	210065

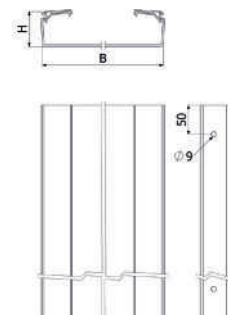

BASORPLAST BPE-P / H100



3m (10ft)	↓↑		↔		PVC UVM1
	mm	inch	mm	inch	
BPE 100X200	100	4"	200	8"	210074
BPE 100X300	100	4"	300	12"	210075
BPE 100X400	100	4"	400	16"	210076
BPE 100X600	100	4"	600	24"	210077

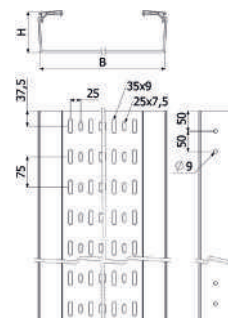

BASORPLAST BPE-C / H100



3m (10ft)	↓↑		↔		PVC UVM1
	mm	inch	mm	inch	
BPE-C 100X200	100	4"	200	8"	210066
BPE-C 100X300	100	4"	300	12"	210067
BPE-C 100X400	100	4"	400	16"	210068
BPE-C 100X600	100	4"	600	24"	210069

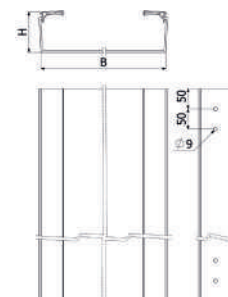

COVER - TAPA TBPE



3m (10ft)	↔		PVC UVM1
	mm	inch	
TBPE 100	100	4"	210078
TBPE 150	150	6"	210079
TBPE 200	200	8"	210080
TBPE 300	300	12"	210081
TBPE 400	400	16"	210082
TBPE 600	600	24"	210083

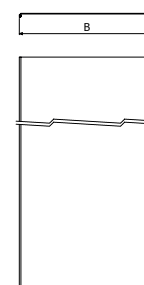



BASORPLAST

BEND-CURVA CPBPE 90°



CPBPE	H100		H60		PVC UVM1
	mm	inch	mm	inch	
CPBPE 60X100	60	2 3/8"	100	4"	210089
CPBPE 60X150	60	2 3/8"	150	6"	210090
CPBPE 60X200	60	2 3/8"	200	8"	210091
CPBPE 60X300	60	2 3/8"	300	12"	210092
CPBPE 100X200	100	4"	200	8"	210093
CPBPE 100X300	100	4"	300	12"	210094
CPBPE 100X400	100	4"	400	16"	210095
CPBPE 100X600	100	4"	600	24"	210096

🔧 2x 📄 +4/8 🛠️

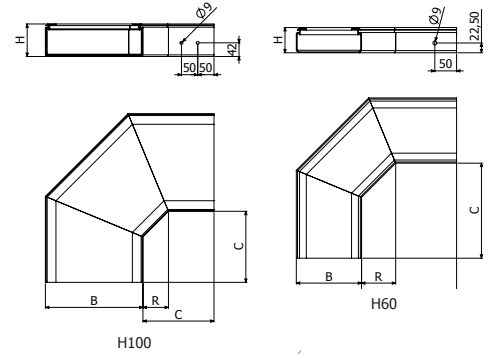

COVER-TAPA TCPBPE 90°



TCPBPE	B		C		PVC UVM1
	mm	inch	mm	inch	
TCPBPE 100	100	4"	220	8 1/2"	210097
TCPBPE 150	150	6"	220	8 1/2"	210098
TCPBPE 200	200	8"	220	8 1/2"	210099
TCPBPE 300	300	12"	220	8 1/2"	210100
TCPBPE 400	400	16"	220	8 1/2"	210101
TCPBPE 600	600	24"	240	9 1/2"	210102

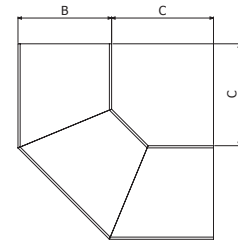

BEND-CURVA CCBPE



CCBPE	H100		H60		PVC UVM1
	mm	inch	mm	inch	
CCBPE 60X100	60	2 3/8"	100	4"	210103
CCBPE 60X150	60	2 3/8"	150	6"	210104
CCBPE 60X200	60	2 3/8"	200	8"	210105
CCBPE 60X300	60	2 3/8"	300	12"	210106
CCBPE 100X200	100	4"	200	8"	210107
CCBPE 100X300	100	4"	300	12"	210108
CCBPE 100X400	100	4"	400	16"	210109
CCBPE 100X600	100	4"	600	24"	210110

🔧 2x 📄 +4/8 🛠️

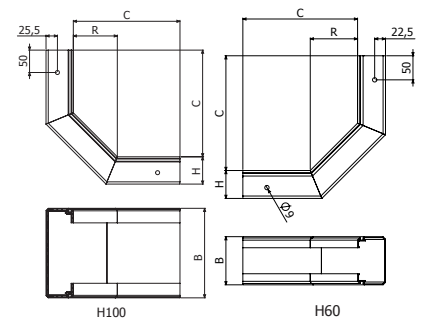

COVER-TAPA TCCBPE



TCCBPE	B		PVC UVM1
	mm	inch	
TCCBPE 60X100	100	4"	210111
TCCBPE 60X150	150	6"	210112
TCCBPE 60X200	200	8"	210113
TCCBPE 60X300	300	12"	210114
TCCBPE 100X200	200	16"	210115
TCCBPE 100X300	300	12"	210116
TCCBPE 100X400	400	16"	210117
TCCBPE 100X600	600	24"	210118

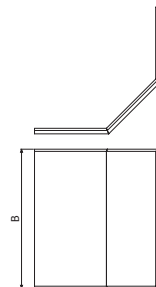

BASORPLAST



BEND-CURVA CXBPE



CXBPE	↕		↔		PVC UVM1
	mm	inch	mm	inch	
CXBPE 60X100	60	2 3/8"	100	4"	210119
CXBPE 60X150	60	2 3/8"	150	6"	210120
CXBPE 60X200	60	2 3/8"	200	8"	210121
CXBPE 60X300	60	2 3/8"	300	12"	210122
CXBPE 100X200	100	4"	200	8"	210123
CXBPE 100X300	100	4"	300	12"	210124
CXBPE 100X400	100	4"	400	16"	210125
CXBPE 100X600	100	4"	600	24"	210126

🔧 2x 📄 +4/8 🛠️

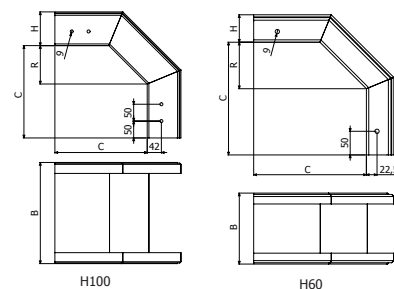

COVER-TAPA TCXBPE



TCXBPE	B		PVC UVM1
	mm	inch	
TCXBPE 60X100	100	4"	210127
TCXBPE 60X150	150	6"	210128
TCXBPE 60X200	200	8"	210129
TCXBPE 60X300	300	12"	210130
TCXBPE 100X200	200	16"	210131
TCXBPE 100X300	300	12"	210132
TCXBPE 100X400	400	16"	210133
TCXBPE 100X600	600	24"	210134

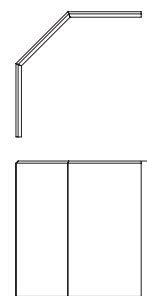

END COVER TFBPE



TFBPE	↕		↔		PVC UVM1
	mm	inch	mm	inch	
TFBPE 60X100	60	2 3/5"	100	4"	223023
TFBPE 60X150	60	2 3/5"	150	6"	223024
TFBPE 60X200	60	2 3/5"	200	8"	223025
TFBPE 60X300	60	2 3/5"	300	12"	223026
TFBPE 100X200	100	4"	200	8"	223027
TFBPE 100X300	100	4"	300	12"	223028
TFBPE 100X400	100	4"	400	16"	223029
TFBPE 100X600	100	4"	600	24"	223030

🔧 2/4 🛠️

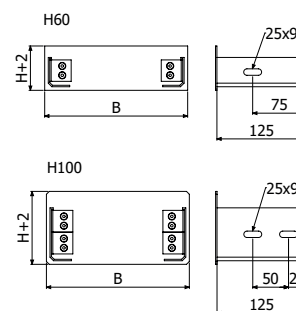

DIVIDER PSBPE



PSBPE	H		PVC UVM1
	mm	inch	
PSBPE 60	60	2 3/5"	210144
TPSBPE 100	100	4"	210145

🔧 4 🛠️

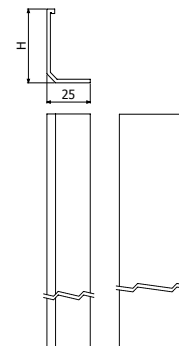



BASORPLAST

UNION JUBPE



JUBPE	mm		PVC UVM1
	mm	inch	
JUBPE 60	60	2 3/8"	210084
JUBPE 100	100	4"	210085
JUBPE-C 400-600	-	-	218797
CTBP	-	-	210017

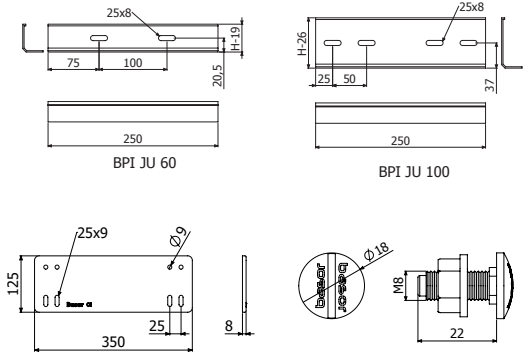

DERIVATION PDBPE



PDBPE	mm	inch	PVC UVM1
			PVC UVM1
PDBPE 60 (2 3/8")			223021
PDBPE 100 (4")			223022

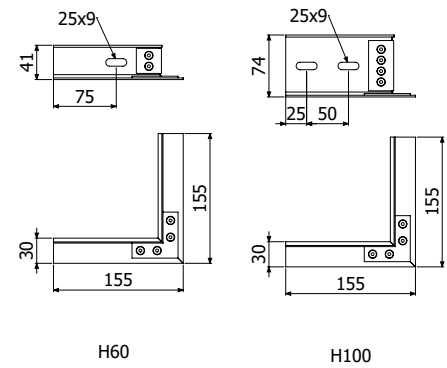

ARTICULATED JUBPE-AB



JUBPE-AB	mm		PVC UVM1
	mm	inch	
JUBPE-AB 60	60	2 3/8"	223613
JUBPE-AB 100	100	4"	223614

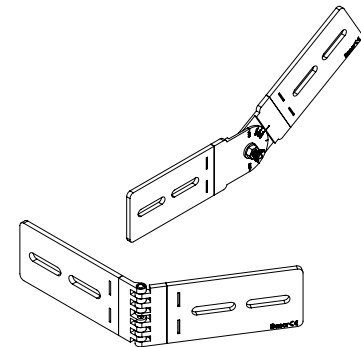
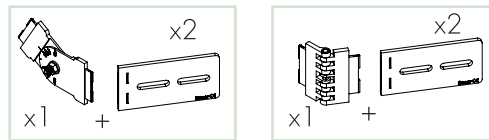

CLAMP BIK10-BPE



BIK10-BPE	e mm	Mod HxB	PVC UVM1	
			i304	i316
BIK10-BPE 60X100	1.5	60x100	217340	217347
BIK10-BPE 60X150	1.5	60x150	217341	217348
BIK10-BPE 60/100X200	1.5	60/100x200	217342	217349
BIK10-BPE 60/100X300	1.5	60/100x300	217343	217350
BIK10-BPE 100X400	2	100x400	217345	217352
BIK10-BPE 100X600	2	100x600	217346	217353

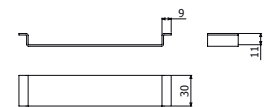

HEAD - KSHGR



KSHGR	mm	PVC UVM1
		PVC UVM1
KSHGR		217282

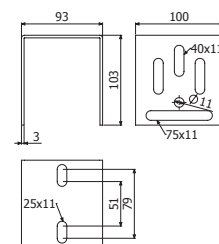

U-PROFILE PSHG-PSHGR



PSHG-PSHGR		
		GSP 7035
PSHG 2M		217281
PSHGR 600		217283
TFSHGR PVC		212112

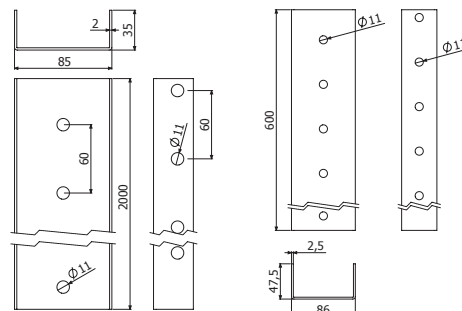

PSHGR

SCREW CT2



CT2		
		PVC UVM1
CT2 M10X100		207228

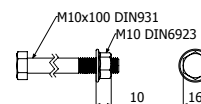

WALL SUPPORT SHG



SHG	↔		
	mm	inch	
SHG 100	100	4"	210011
SHG 150	150	6"	210012
SHG 200	200	8"	210013
SHG 300	300	12"	210014
SHG 400	400	16"	210015
SHG 600	600	24"	210016

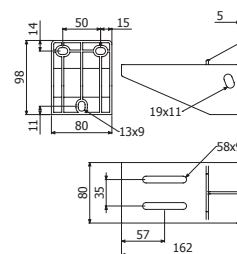

SHG100

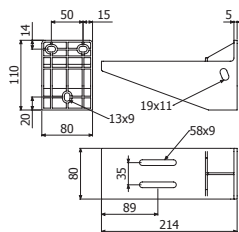

SHG150

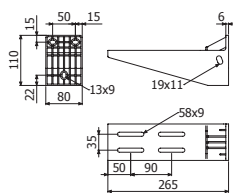

SHG200

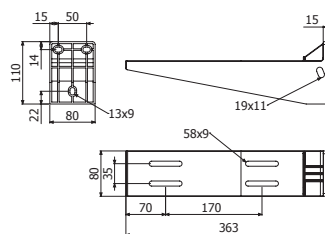

SHG300

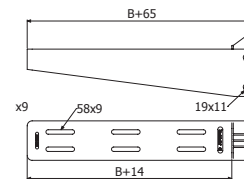

SHG 400/600

FLOOR SUPPORT SVG



SVG	↔		
	mm	inch	
SVG 100	100	4"	210050
SVG 150	150	6"	210051
SVG 200	200	8"	210052
SVG 300	300	12"	210053
SVG 400	400	16"	210054
SVG 600	600	24"	210055

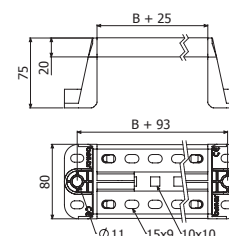



BASORPLAST

Application on brackets Aplicación en soporte



Floor
Support SVG

Suelo
Soporte SVG



Wall
Support SHG

Pared
Soporte SHG



Ceiling
Support SVG

Techo
Soporte SVG





BASORPLAST

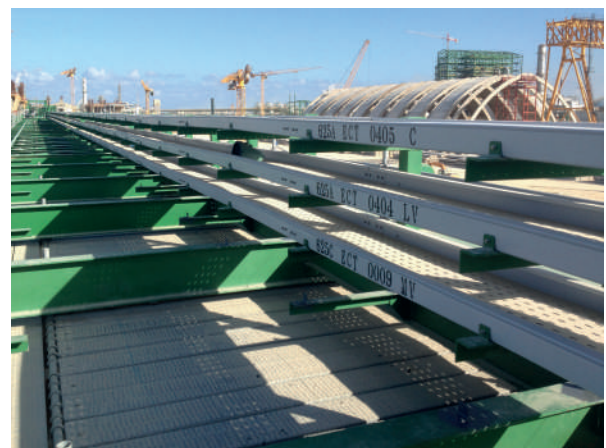
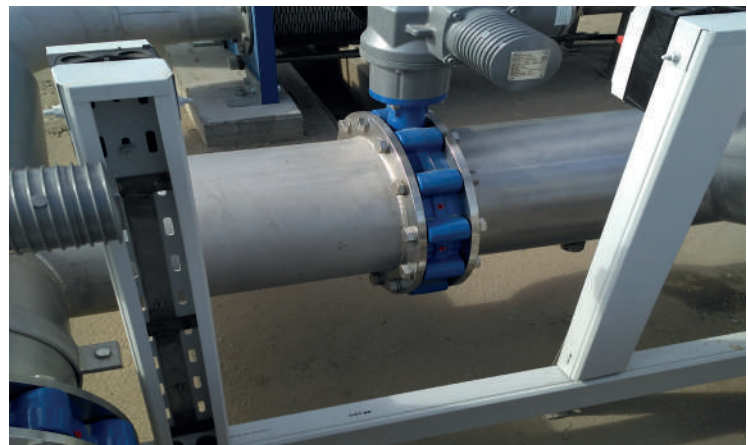

BASORPLAST: USOS Y CREACIÓN DE ACCESORIOS | 53



PRESENCIA A NIVEL MUNDIAL

- 10 Filiales internacionales
- 50 Países con stock de productos
- 1.200 Distribuidores globales

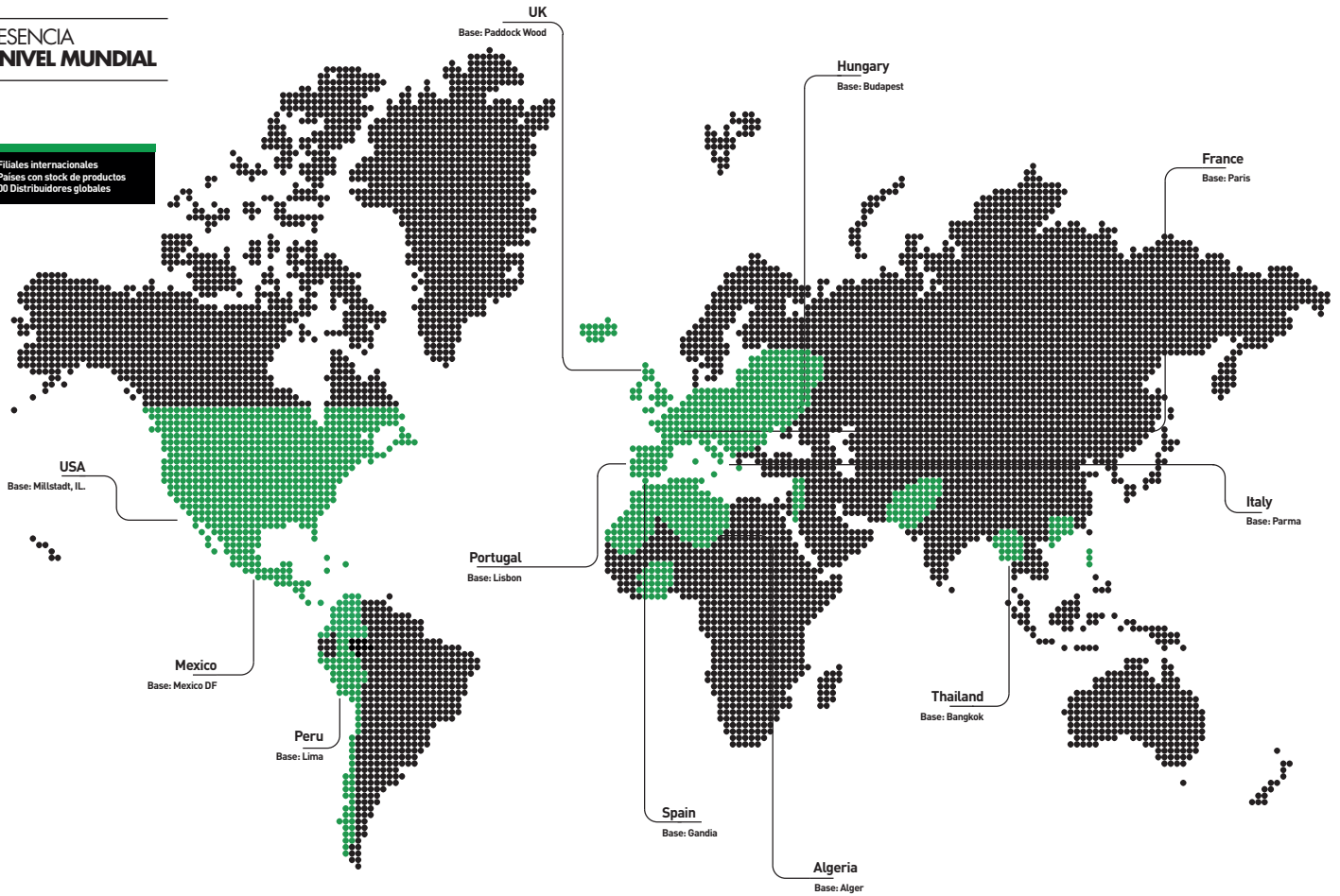

SPAIN HEADQUARTERS

Avenida Alcodar 45-47
46701 Gandia SPAIN
T. +34.962.876.695
basor@basor.com

PERU Basor Perú S.A.C

Calle Venancio Ávila 1988
Lima (Perú)
T. +51.1.759.8367
peru@basor.com

USA Basor Electric Inc.

604 Mulberry Street Millstadt
ILinois 62260, USA
T. 844 393 3985
customer.service@basor.com

ITALY Basor Electric SRL

Via B. Franklin, 31
43122 Parma
T. +39.0521.798.360
commerciale@basor.com

MEXICO Basor México SAPI

Carretera México-Cuautitlán km31.5 - b.33
54800, Cuautitlán, Edo. México, MX
T. +52.55.5546.9092
atencionmx@basor.com

THAILAND Basor THAI

166/26 soi Charoenporn Charansani-
twong rd., Baanchanglor
Bangkoknoi, Bangkok 10500
T. +66 0 2 9152300

HUNGARY Basor Elektro KFT

Grassalkovic U.255
H-1239 Budapest
T. +361.297.0204
basorelektro@basor.com

FRANCE Basor France

200 Chaussée Jules César Bat
A4 95250, BEAUCHAMP (France)
T. +33 01 3978 4982
basorelectric@basor.com

PORTUGAL Basor Caminho de Cabos

Parque Empresarial Quimiparque
Edif. 153, rua nº42, 21
2830 Barreiro (Lisboa)
T. +351.212.071.165
armazem@basor.com

ARGELIA Basor SARL M.N.A Equips

28, Avenue Colonel Bougara
Velle-vue, El-Harrach
T. +213.2152.6234
algerie@basor.com

UNITED KINGDOM Basor Electric LTD

Unit 23, Eldon Way Industrial Estate
Paddock Wod, TN12 6BE, Kent
T. +44.1892.833.500
basoruk@basor.com



SÍGUENOS EN LAS REDES SOCIALES

SÍGUENOS EN



@Basor Electric SA

SÍGUENOS EN



@BasorElectric

SÍGUENOS EN



@BasorElectric

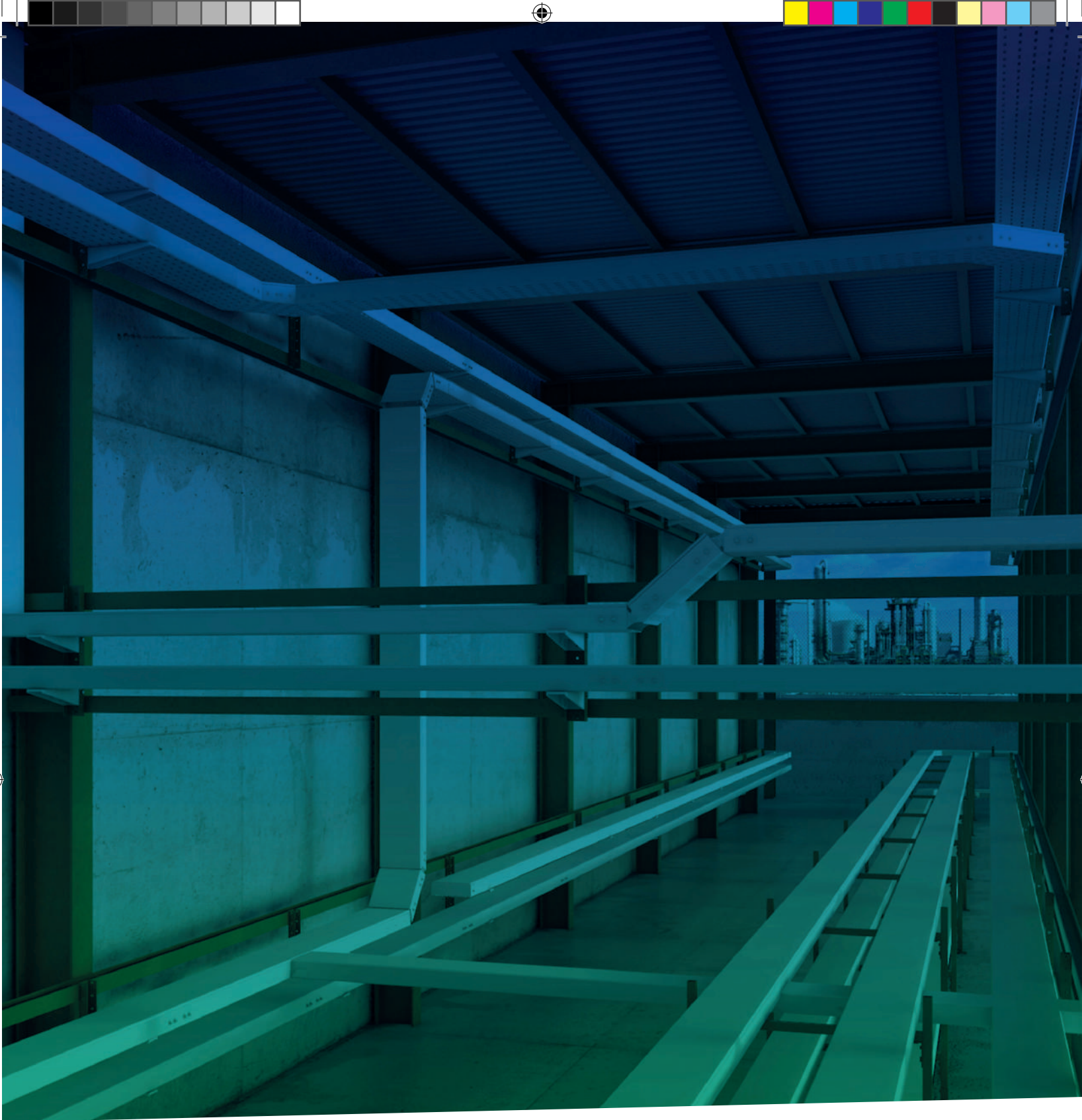

BE Basor

CABLE TRAY SPECIALIST



Basor Electric SA



@Basorelectric



/Basorelectric



www.basor.com