

PCE

Connection
to the future



FLEX

Enclosure for low-voltage switchgear assemblies

FLEX 6-E / 10-E / 16-E

FLEX 6-S3 / 10-S4 / 16-S6



FLEX

Enclosure for low-voltage switchgear assemblies

The series **FLEX** enclosures are suitable for low voltage switchgear combinations and designed for both indoor and outdoor applications. 3 different sizes are available as unequipped enclosures for self assembly - optionally with closed cover (blind) or prefabricated cut-outs for the installation of add-on sockets.

The solid, high-quality ABS housing, which has been tested and certified according to IEC/EN 62208, has **IP66/67** protection and impact protection of **IK08** as well as numerous other positive features. Under the transparent hinged window there is also sufficient space for switchgear up to 16 modules.

All in all, this enclosure series offers maximum **FLEX**ibility for a wide range of applications.

Maximum **FLEX**ibility...

Housing bottom part

Housing top part
with foamed seal



Hinged window
with snap lock and shut-off device

Mounting rail
TH35-7,5

Drill marks
for cable glands

Opening
for sealing



Hinge strap



Screw cover

Safety socket
(optional)

Flange adapter
50x50 (optional)

Blind flange
80x97

CEE mounted socket
80x97 (optional)

Housing screw
made of plastic, captive

FLEX

Enclosure for low-voltage switchgear assemblies

Enclosure closed



FLEX 6-E

Scope of delivery

- bottom part of housing with mounted mounting rail for max. 6 modules
- closed top part of housing with mounted hinged window
- 2x hinge strap with screws
- 2x screw cover

15850600



FLEX 10-E

Scope of delivery

- bottom part of housing with mounted mounting rail for max. 10 modules
- closed top part of housing with mounted hinged window
- 2x hinge strap with screws
- 4x screw cover

15851000



FLEX 16-E

Scope of delivery

- bottom part of housing with mounted mounting rail for max. 16 modules
- closed top part of housing with mounted hinged window
- 2x hinge strap with screws
- 4x screw cover

15851600

Enclosure with cut-outs

**FLEX 6-S3****Scope of delivery**

- bottom part of housing with mounted mounting rail for max. 6 modules
- top part of housing with mounted hinged window and 3 cut-outs for flanged sockets (80x97mm)
- 1x blind flange with seal
- 12x flange screws
- 2x hinge strap with screws
- 2x screw cover

15850603

**FLEX 10-S4****Scope of delivery**

- bottom part of housing with mounted mounting rail for max. 10 modules
- top part of housing with mounted hinged window and 4 cut-outs for flanged sockets (80x97mm)
- 1x blind flange with seal
- 16x flange screws
- 2x hinge strap with screws
- 4x screw cover

15851004

**FLEX 16-S6****Scope of delivery**

- bottom part of housing with mounted mounting rail for max. 16 modules
- top part of housing with mounted hinged window and 6 cut-outs for flanged sockets (80x97mm)
- 1x blind flange with seal
- 24x flange screws
- 2x hinge strap with screws
- 4x screw cover

15851606

Technical data

Outside dimensions	6-E/6-S3	10-E/10-S4	16-E/16-S6
Height (mm)	471	471	471
Width (mm)	160	230	330
Depth (mm)	132	158	158
Inside dimensions - protected space			
Height (mm)	461	461	461
Width (mm)	150	220	320
Depth (mm)	72	92	92
Load capacity (max.kg)	10	10	10
Weight (kg)	1,4	1,9	2,5
Power dissipation capacity P _{de} (W)*	33	44	57
Material housing	ABS		
Color housing	similar to RAL7035		
Ambient temperature	-25°C to +40°C		
Transport and storage temperature	-25°C to +55°C / short-term (24h) up to +70°C		
Humidity for indoor installation	Max. 50% at max. ambient temperature of +40°C		
Humidity outdoor	Temporarily 90% at max. ambient temperature of +20°C		
IP-degree of protection	IP66/67		
IK impact resistance	IK08		
Pollution degree	3		
Rated insulation voltage	690 V		
Maximum installation height over sea level	2000m N.N.		
Glow wire strength IEC/EN 60695-2-11	650°C		
Directives	Low Voltage Directive 2014/35/EU RoHS 2011/65/EU and 2015/863/EU		
Standards	IEC/EN 62208		

* valid for single housing for wall mounting

The technical data listed apply only to the intended use of the FLEX enclosure.

Dimensions

FLEX 6-E

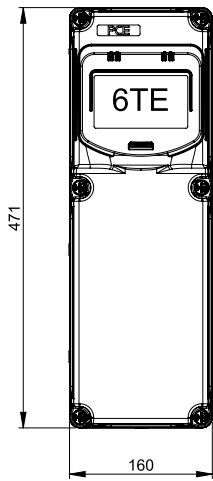

FLEX 6-S3

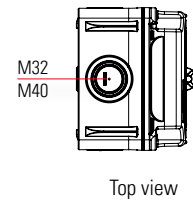
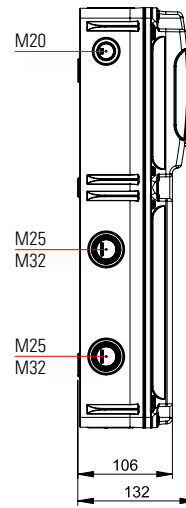
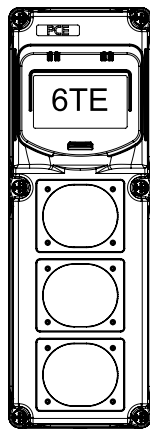

FLEX 10-E

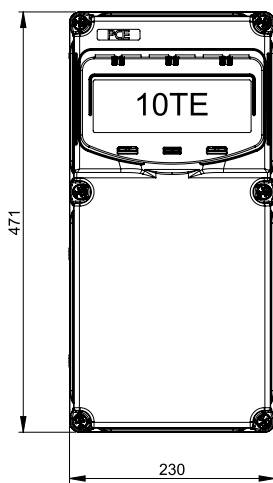

FLEX 10-S4

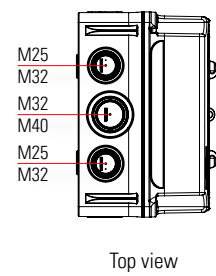
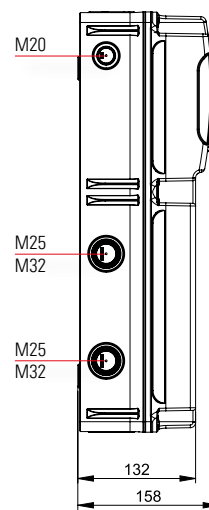
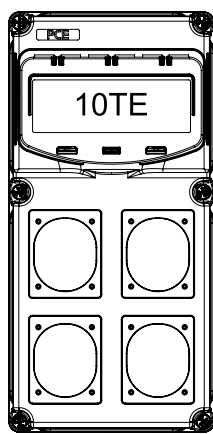

FLEX 16-E

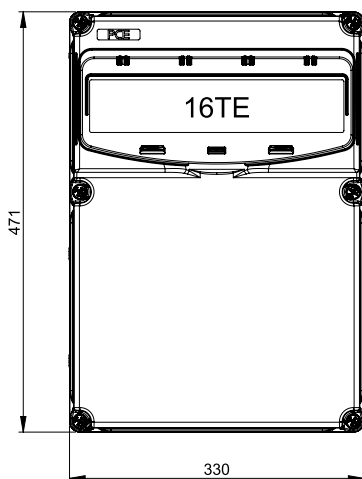

FLEX 16-S6

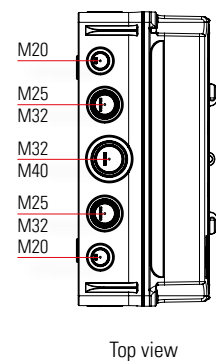
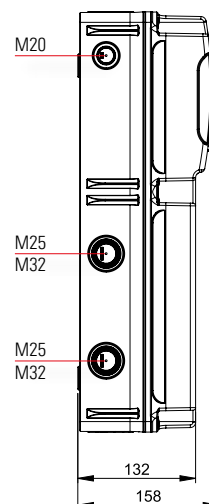
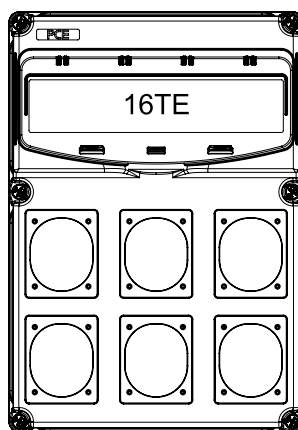

FLEX

Enclosure for low-voltage switchgear assemblies

Accessories

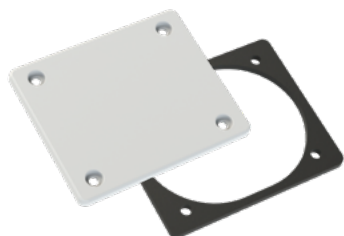

Blind flange

Set includes:

- 6x flange adapter 80x97 - blind
- 6x flange seal

158500

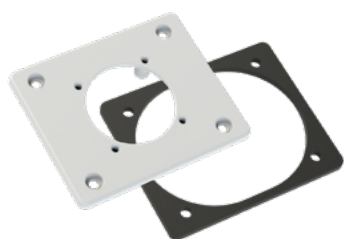

Flange adapter 50x50

Set includes:

- 6x flange adapter 80x97 for 50x50mm safety sockets
- 6x flange seal
- Pan head screws for mounting of flanged sockets

158550



Handle

only for FLEX 10 and 16

Set includes:

- Handle
- Screws
- Cap nuts (isolated)



158502



Cover rail

Cover rail blind for 6 modules



2119100



Universal rack

only for FLEX 16-E/16-S6



598053

Mounting kit for universal rack

Set includes:

- Screws
- Cap nuts (isolated)



158503

Cable glands IP66/68 plastic, color light gray (RAL7035)

size	thread length (mm)	cable-Ø (mm)	width across flats (mm)	pack. unit (MOQ)	Cat.No.
M20x1,5	9	6-12	24	100	23201509141
M25x1,5	15	13-18	33	50	23251511181
M32x1,5*	15	18-25	42	25	23321511211
M40x1,5*	18	22-32	53	10	23401513321

*incl. flat seal



Blind screw fittings IP54 plastic, color light grey (RAL7035)

size	thread length (mm)	pack. unit (MOQ)	Cat.No.
M25x1,5	7	100	2725151010
M32x1,5	8	100	273215101
M40x1,5	9	100	274015101



Lock nut brass nickel coated

size	height (mm)	width across flats (mm)	pack. unit (MOQ)	Cat.No.
M20x1,5	3	24	100	262015009
M25x1,5	3,5	29	100	262515009
M32x1,5	4	36	100	263215009
M40x1,5	4,5	46	50	264015009



Sealing ring rubber black

size	height (mm)	Ø outside (mm)	Ø inside (mm)	pack. unit (MOQ)	Cat.No.
M20	1	23,5	18,2	100	410814
M25	1	29,5	23,2	50	410808
M32	1	36,5	30,2	25	410810
M40	1	45,5	38,2	10	410811



Pressure screw plastic, color light gray (RAL7035)

size	thread length (mm)	width across flats (mm)	Ø inside (mm)	pack. unit (MOQ)	Cat.No.
M32x1,5	14,5	34	26	25	0530
M40x1,5	16	42	34	10	0526



FLEX

Enclosure for low-voltage switchgear assemblies

Flanged sockets

Safety socket IP54 ^{P-NOVA} PLUS⁺

Flange 50x50mm



	rear connection	pack. unit (MOQ)	Cat.No.
	Austrian/German system	100	1050-0b
	French/Belgian system	100	1040-0b
	side connection		
	Austrian/German system	100	1050-0bs
	French/Belgian system	100	1040-0bs

Safety socket IP54 S-NOVA[®]

Flange 50x50mm



	rear connection	pack. unit (MOQ)	Cat.No.
	Austrian/German system	100	105-0b
	French/Belgian system	100	104-0b
	side connection		
	Austrian/German system	100	105-0bs
	French/Belgian system	100	104-0bs

Data socket IP54

Flange 50x50mm



12k452-0e

	pack. unit (MOQ)	Cat.No.
incl. 2x CAT 6 _A RJ45 module	1	12k452-0e
Data socket with hinged lid (empty), 1x opening	1	110m-0e
Module CAT 6 _A RJ45	1	093617
Module USB 2.0 A / USB 2.0 A	1	086317



CEE flanged socket sloping IP44/54

with screw terminals, brass contacts, flange 80x97mm

		pack. unit (MOQ)	Cat.No.
230V~	16A 3-pole 6h	10	413-6f8
400V~	16A 4-pole 6h	10	414-6f8
400V~	16A 5-pole 6h	10	415-6
230V~	32A 3-pole 6h	10	423-6
400V~	32A 4-pole 6h	10	424-6
400V~	32A 5-pole 6h	10	425-6



CEE flanged socket sloping IP67

with screw terminals, brass contacts, flange 80x97mm

		pack. unit (MOQ)	Cat.No.
230V~	16A 3-pole 6h	10	4132-6f8
400V~	16A 4-pole 6h	10	4142-6f8
400V~	16A 5-pole 6h	10	4152-6f78
230V~	32A 3-pole 6h	10	4232-6f78
400V~	32A 4-pole 6h	10	4242-6f78
400V~	32A 5-pole 6h	10	4252-6f78



Further accessories and technical data are listed in the PCE product catalog: www.pcelectric.at

PCE

Connection
to the future



www.pcelectric.at

PC Electric GesmbH

Diesseits 145

4973 St. Martin im Innkreis

AUSTRIA

TEL +43 7751 61220

FAX +43 7751 6969

office@pcelectric.at

098389

Version 05/2022

No guarantee for technical changes
or printing errors.

