

# **GODDE**<sup>®</sup> **WATER PUMP**

**Water Pumps  
Pompes à eau  
Bombas de agua  
Pompe acqua  
Wasserpumpen  
Водяной насос  
水泵**

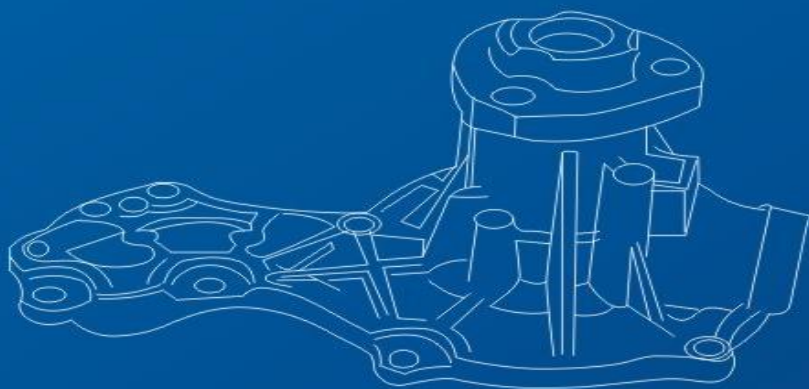

**台州浩森机电有限公司**

**TAIZHOU HAWTHORN MECHANICAL&ELECTRICAL CO.,LTD.**



**GDOB**

## 台州浩森机电有限公司

TAIZHOU HAWTHORN MECHANICAL&ELECTRICAL CO.,LTD.

地址:浙江省台州市玉环市坎门街道解放塘路152号, 创业孵化园。

Add:NO. 152 Jiefangtang Road, Kanmen, Yuhuan, Zhejiang, China.

电话(Tel): +86-576-87552692, 87564881

传真(Fax): +86-576-87558692

E-mail:Manager@hawthorn.cn.com

Http://www.hawthorn.cn.com

**GDOB®**



台州浩森机械有限公司成立于1997年10月，坐落在中国汽摩配生产基地-玉环,是一家集研发、生产、销售为一体的专业汽车水泵制造商。企业自成立以来一直秉持“品质第一，客户至上”的企业宗旨，深受国内外广大客户的青睐，各种车型的水泵远销欧美、南美、中东、亚洲、非洲等地区，多年来深受中外客户的一致好评。

企业拥有先进的生产加工设备、优秀的技术人员、精湛的制造工艺、检测设备、完善的管理制度，从而生产出高质量能满足客户需求的水泵产品。目前，企业已经开发生产了1500余种适用于不同车系的水泵，如韩国、日本、欧美、俄罗斯等车系，并且还在不断丰富之中，以此满足不同顾客的需求。

我们热烈欢迎来自世界各国的客商来企参观，洽谈，合作！

TAIZHOU HAWTHORN MECHANICAL&ELECTRICAL CO.,LTD. is located in Yuhuan, a port city which is a reputable manufacturing automobile part industrial in China.

We are specializing in producing, researching and exporting auto water pump for more than twenty years. The exported water pumps are subject to stringent quality control through out the manufacturing process. The product must pass a special pressure and leakage test one by one. This ensures that every water pump we produced is fulfilled high standards in quality and reliability.

Through protracted and unremitting efforts these years. our factory now can produce more than 1500 kinds of water pump. With high quality and competitive price, our products have been exported to Europe, South America, Mid-East, Africa, East-Asia and other areas and have received good reputation for good quality and sound service.

We are always dedicated to pursue client's satisfaction and requirement. Superior quality products and first-class service is our target.

TAIZHOU HAWTHORN MECHANICAL&ELECTRICAL CO.,LTD. welcomes interior and exterior clients and experts to guidance, cooperate and negotiate business with us for mutual benefits.

## WATER PUMP



### ▲ SEAL 水封

High quality, durable and unitized seal ensures leak-free pump performance.

高品质、长寿命的一体式水封能有效减少泄露，确保水泵无忧工作。



### ◀ BEARING 轴连轴承

Constructed as one unitized component, bearing/shaft assemblies are designed to withstand rigorous working load from the belt tension and/or fan clutch assembly.

具有高转速和更大的承载能力，承受来自皮带张力和风扇的工作负荷。



### ◀ HUB-PULLEY 法兰盘

Precisely pressed onto shaft with tight tolerances to endure working loads and conditions.

和轴承紧密配合，精确控制压装载荷，确保其能够承受来自皮带轮的扭矩。

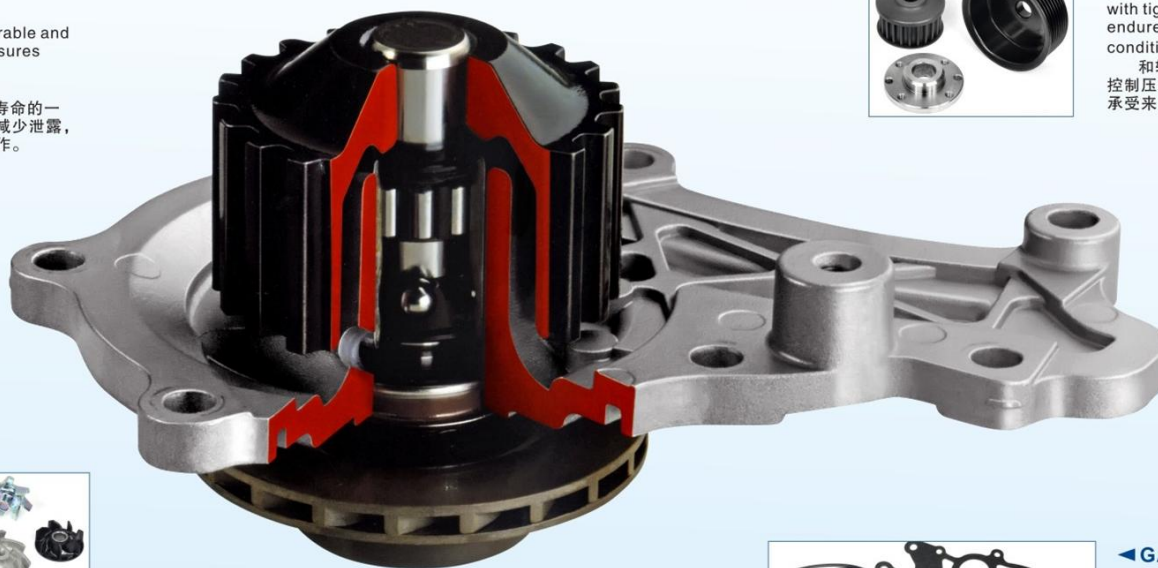

### ◀ HOUSING 壳体

Computerized machined surface and inside cavity is designed to match OE performance for proper coolant flow

精湛设计与发动机浑然一体，精准的液体流动使之符合原车品质。



### ▲ IMPELLER 叶轮

Engineered and balanced to ensure optimal coolant flow for top performance.

优良的冷却系统来自叶轮与壳体的绝妙配合。



### ◀ GASKET 密封垫

High quality gaskets ensure a tight, leak-free interface between mounting surfaces

高品质密封垫杜绝了安装面之间的泄露。

车间环境

Workshop  
Equipment

GDOB®

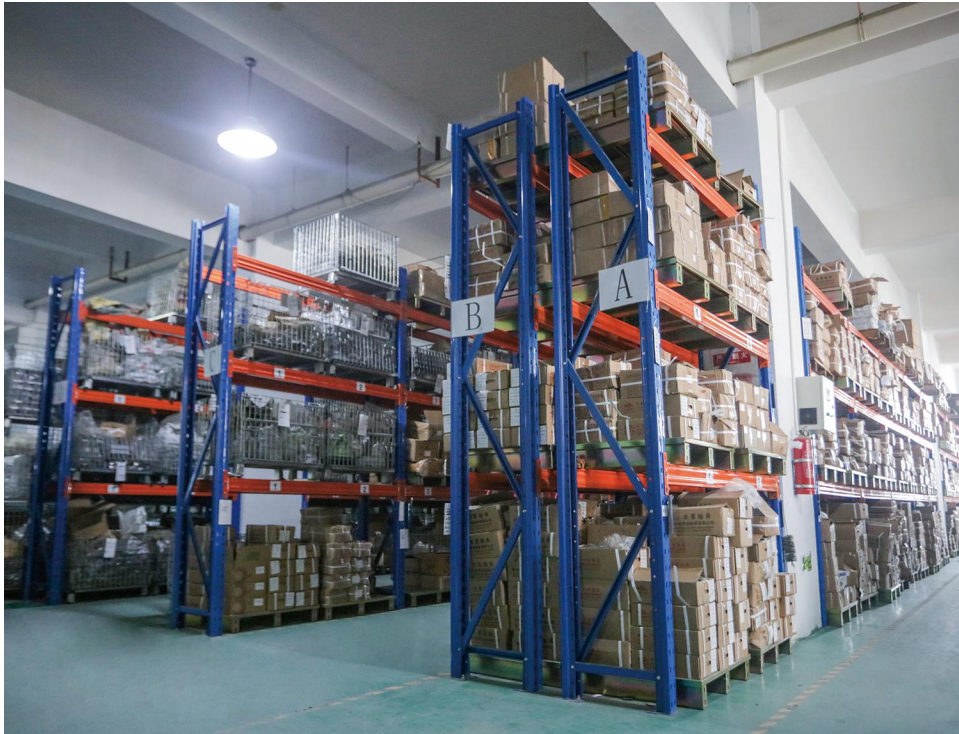

检测设备

Inspection  
Lab

GDOB®



质量认证

Quality  
Certification

GDOB®



### Certificate of registration

Registration No. : BRC21Q10522R05

This is to certify that

**TAIZHOU HAWTHORN MACHANICAL & ELECTRICAL  
CO.,LTD.**

Unified Social Credit Code: 91331021255342811L  
Registration Address: No.22 Fukang Road, Shuulong Village, Kanmen Street, Yuhuan City  
Business Address: No.152 Jiefangtang Road, Kanmen Street, Yuhuan City, Zhejiang  
Province, 317602 China

The management system is in conformity with

**GB/T19001-2016/ISO9001:2015 standard**

Scope:

**Manufacture of automobile water pumps**

Issue Date: Dec 15th, 2021

Term of Validity: Dec 14th, 2024

NOTE: The certification organizations must accept the supervision and audit and verification qualified regularly this certificate continues effective message starting from 2022-12-16, the certificate is valid only with a corresponding Notification of Maintaining Registration Qualification. This certificate can be found in CNCA website [www.cnca.gov.cn](http://www.cnca.gov.cn) or check via BRC website [www.brc-china.com.cn](http://www.brc-china.com.cn)

Issued by:

Company seal:

**Beijing ZHONGRUI Unite Certification Co., Ltd**

address: Room 806 of 2-16, No.1 Building on 50# of wangjing west road,  
Chaoyang District, Beijing.

Postcode: 100102

Website: [www.brc-china.com.cn](http://www.brc-china.com.cn)

Tel: 010-84294209

E-mail: [BRC\\_BJ@126.com](mailto:BRC_BJ@126.com)



### 质量管理体系认证证书

注册号: BRC21Q10522R05

兹证明

**台州浩森机电有限公司**

统一社会信用代码: 91331021255342811L

注册地址: 玉环市坎门街道水龙村富康路 22 号 邮编: 317602  
生产/经营地址: 浙江省玉环市坎门街道解放塘路 152 号 邮编: 317602

管理体系符合

**GB/T19001-2016/ISO9001:2015 标准**

认证覆盖范围

**汽车水泵的制造**

发证日期: 2021 年 12 月 15 日

证书有效期至: 2024 年 12 月 14 日

注: 获证组织必须定期接受监督审核并经审核合格此证书方继续有效的提示信息。自 2022-12-16 起, 本证书与《保持认证注册资格通知书》一并使用方为有效; 本证书信息可在国家认证认可监督管理委员会官方网站 ([www.cnca.gov.cn](http://www.cnca.gov.cn)) 上查询, 也可通过公司网站 [www.brc-china.com.cn](http://www.brc-china.com.cn) 查询。

签发人:

公司公章:

**北京中瑞联合认证有限公司**

地址: 北京市朝阳区望京西路甲50号1号楼2-16房间内806室

邮编: 100102

网站: [www.brc-china.com.cn](http://www.brc-china.com.cn)

电话: 010-84294209

邮箱: [BRC\\_BJ@126.com](mailto:BRC_BJ@126.com)





生产范围

Production  
Scope

GDOB®

轿车  
CAR

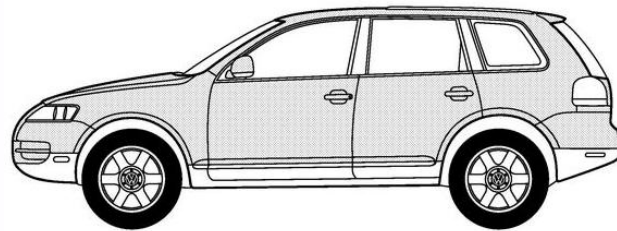

商务车  
Commercial Vehicle

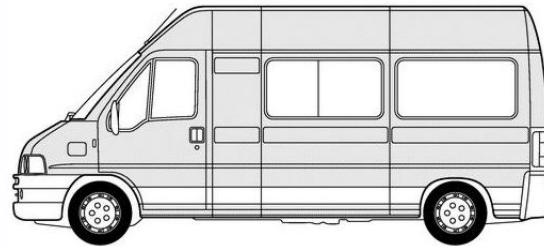

客车  
BUS

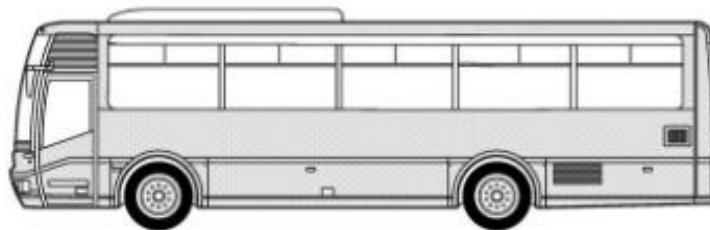

轻/重卡车、工程机械  
Light/Heavy Trucks、  
Engineering Machinery

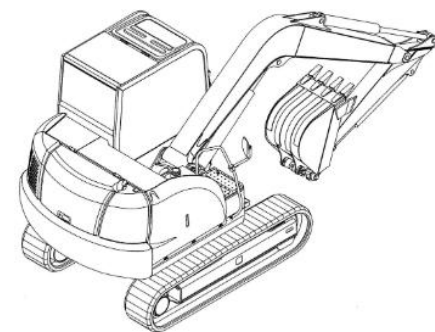

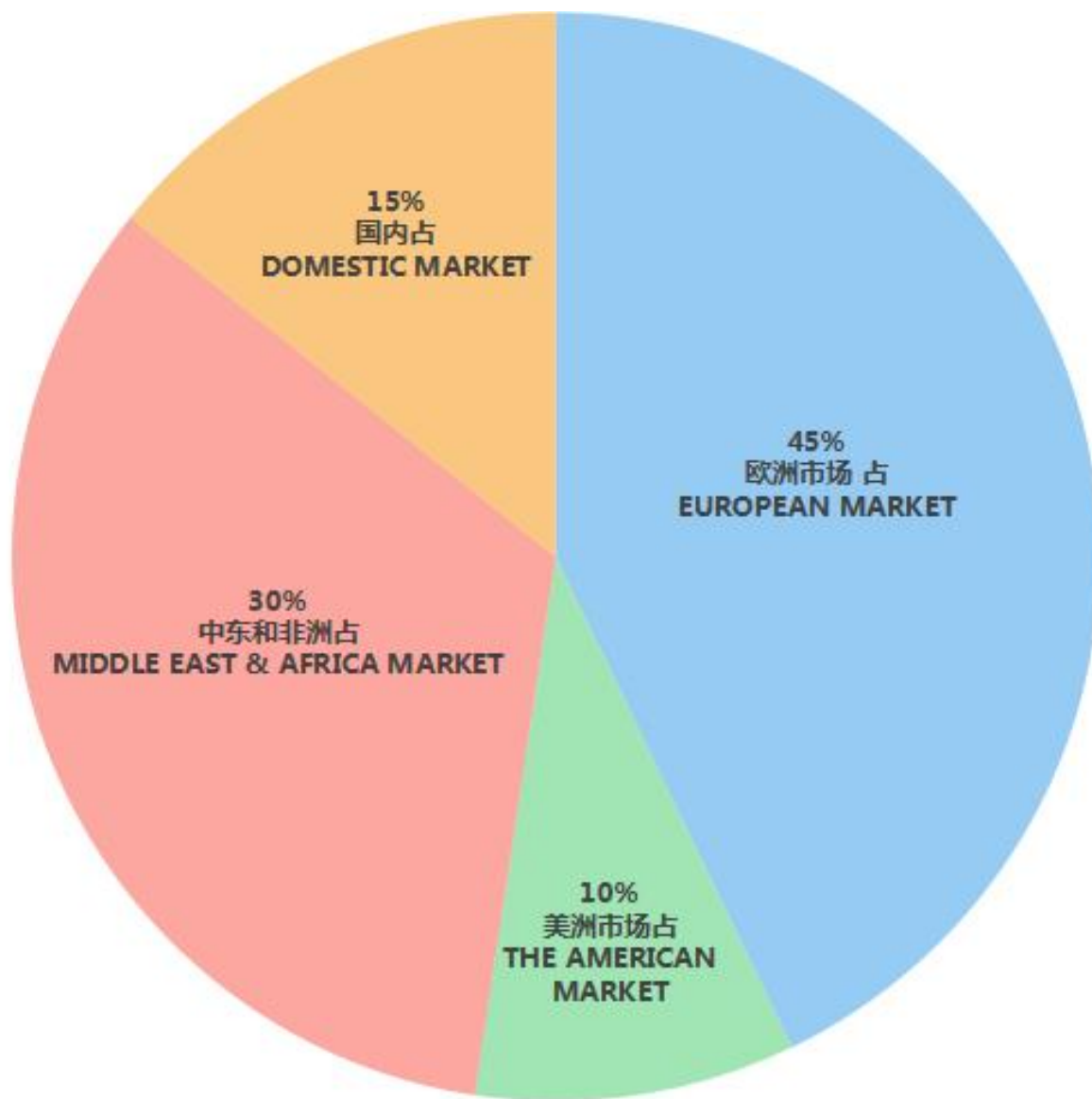



**HAND IN HAND ALTOGETHER WINS!**

