

INOX TERM

Chimneys

Type PT25

Stainless steel chimney system with 25mm insulation

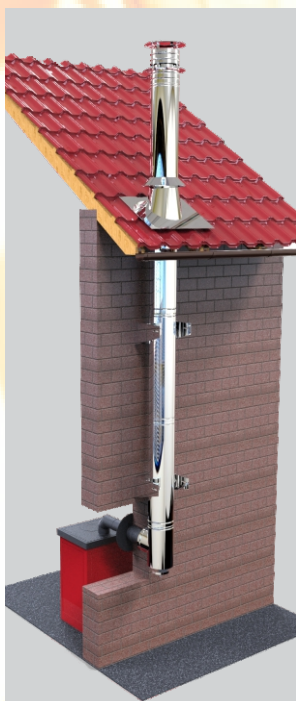

Technical information

Pt25 is a universal metal chimney system of high performance. It is designed to provide a perfect balance between exceptional technical characteristics, safety, design and economy.

The Pt25 system is a successful project which according to the standard EN1856-1 binds the maximum operating temperature (600 ° C) and the resistance to soot combustion (1000 ° C / 30min) with the minimum allowable distance of combustible material (50mm) and with the minimum allowable insulation (25mm). Thus the combination of maximum security, space-saving and cost-efficiency was obtained.

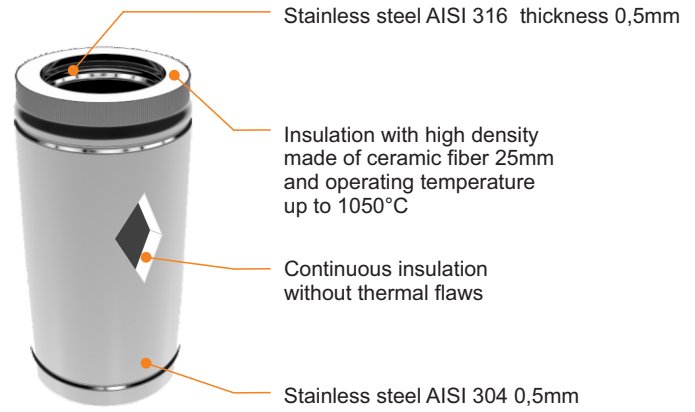

Classification of metal chimneys according to EN 1856-1

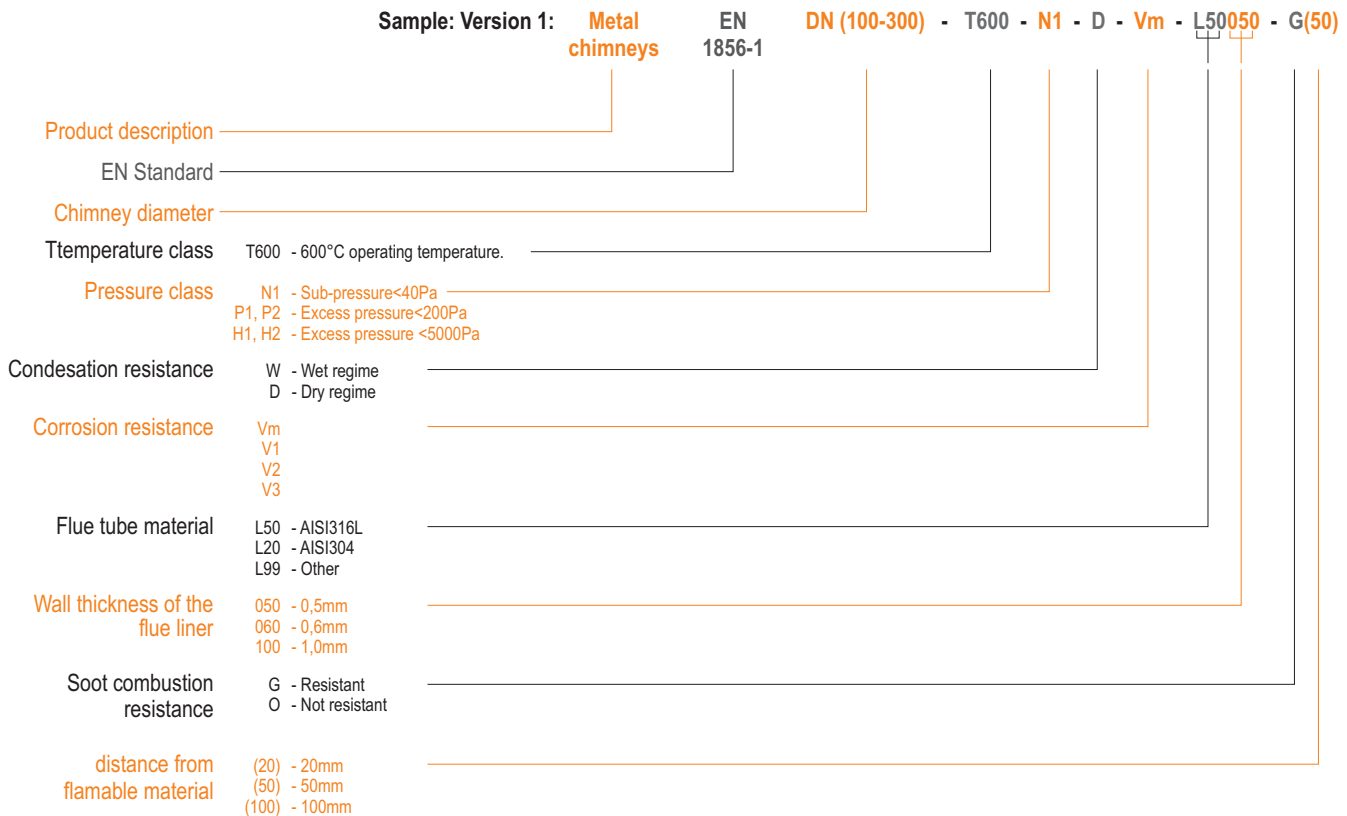

<p>model 1 DN (100-300) - T600-N1-D-Vm-L50050-G(50)</p> <p>model 1 DN (350-450) - T600-N1-D-Vm-L50060-G(100)</p> <p>model 1 DN (500-700) - T600-N1-D-Vm-L50100-G(150)</p>	<p>Metal chimney for operating temperatures up to 600°, works at negative pressure without condensation. It is soot combustion resistant. Safety distance from flammable material is dependent on diameter in accordance with classification 50-150mm. Suitable for solid, liquid and gaseous fuel.</p>
<p>model 2 DN (100-300) - T600-N1-W-Vm-L50050-O(50)</p> <p>model 2 DN (350-450) - T600-N1-W-Vm-L50060-O(100)</p> <p>model 2 DN (500-700) - T600-N1-W-Vm-L50100-O(150)</p>	<p>Metal chimney for operating temperatures up to 600°, works at negative pressure with or without condensation. It is not soot combustion resistant. Safety distance from flammable material is dependent on diameter in accordance with classification 50-150mm. Suitable for liquid and gaseous fuel.</p>
<p>model 3 DN (100-500) - T200-P1-W-Vm-L50050-O(20)</p>	<p>Metal chimney for operating temperatures up to 200°, works at positive pressure with or without condensation. It is not soot combustion resistant. Safety distance 20mm. Suitable for liquid and gaseous fuel.</p>
<p>model 4 DN (100-500) - T200-H2-W-Vm-L50050-O(20)</p>	<p>Metal chimney for operating temperatures up to 200°, works at positive pressure up to 5000Pa with or without condensation. It is not soot combustion resistant. Safety distance 20mm. Suitable for liquid and gaseous fuel.</p>

Interconnection sistem

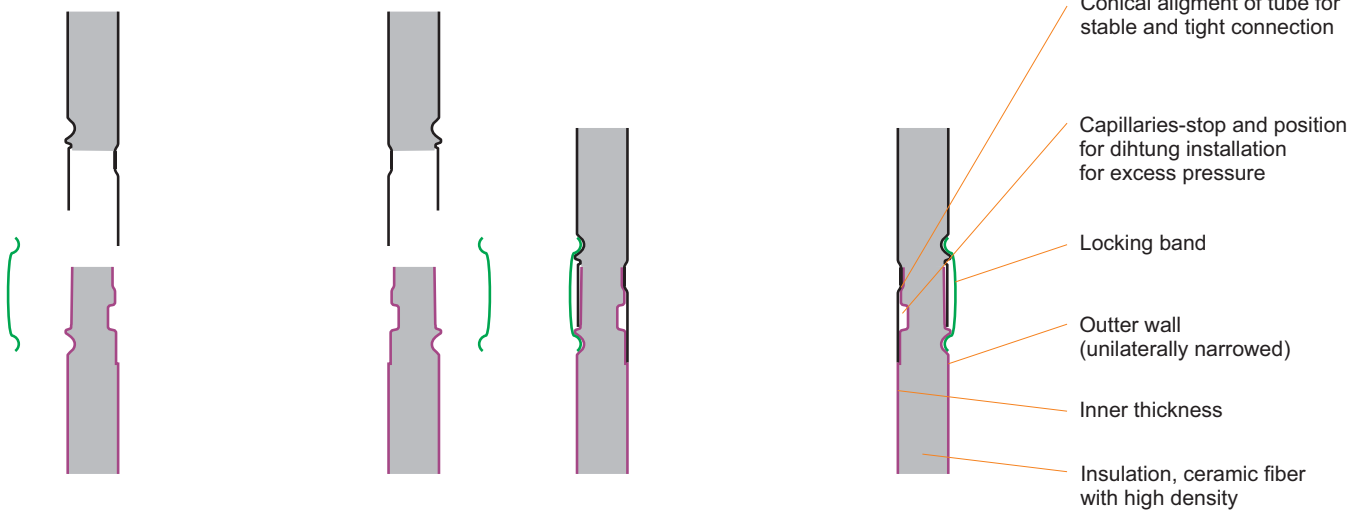

image 1

Through constant contact with the installers and their suggestions, all the while thinking about design and the safety, a system of locking band has been developed. The strenght of the fastener can be adjusted manually without the need for additional tools which make the assembly pleasant and fast. By tightening the **locking band** every connection is perfect and tight - no subsequent correction is necessary.



image 2



Locking band statical

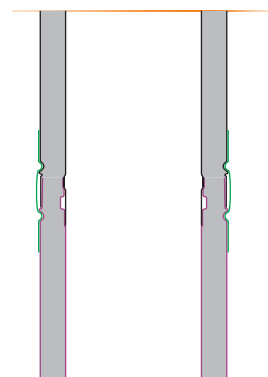

The normal design height of chimneys above the roof is 1,0-2,0m. Sometimes that height is not enough because of the height of the surrounding objects or the required calculation of the chimney-height. To meet the requirements for the total chimney height and to maintain the safety of the chimney construction, with the Pt25 system each of these problems is resolved in advance. For each freestanding height, the solution is a bracket with 2 telescoping rods which are supporting the chimney by relying on the roof structure (cat. nr. Ptn50xx, 51xx, 53xx.) However, for freestanding heights up to 4,0m, the Pt25 system have also **statical locking bands** for which no bars and extra work on the roof are required. With the help of 3 clamps, deep gutters and bigger widths, the **statical locking band** provides safety from the distortion of the chimney up to 4,0m

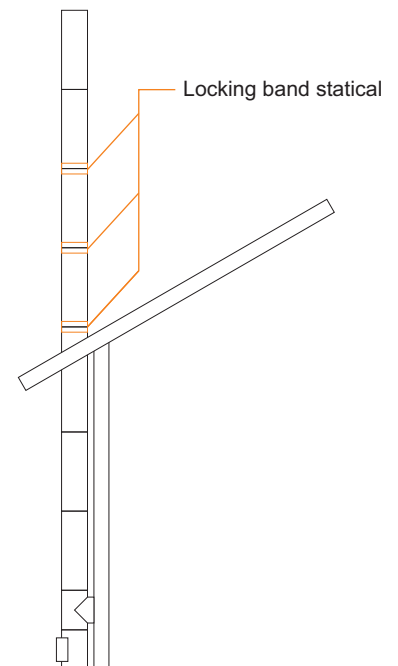

combination 2 elbows with same angle 90 and 60°

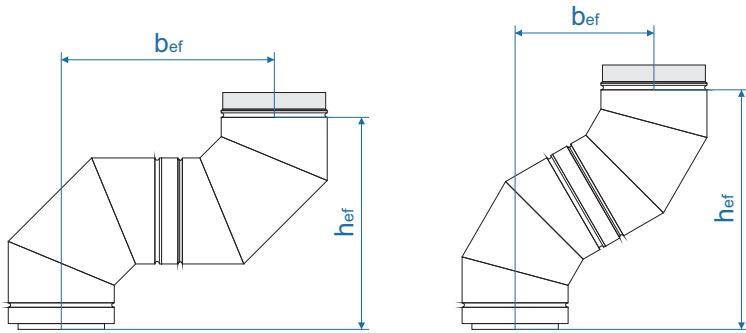

Inner diameter	Outer diameter	90°		60°	
		h _{ef}	b _{ef}	h _{ef}	b _{ef}
100	150	385	385	459	265
130	180	415	415	485	280
150	200	435	435	502	290
160	210	445	445	511	295
180	230	465	465	528	305
200	250	485	485	545	315
250	300	535	535	589	340
300	350	585	585	632	365

combination 2 elbows with same angle 45, 30 and 15°

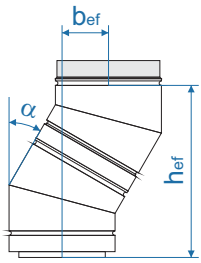

Inner diameter	Outer diameter	45°		30°		15°	
		h _{ef}	b _{ef}	h _{ef}	b _{ef}	h _{ef}	b _{ef}
100	150	362	150	355	95	334	44
130	180	383	159	370	99	341	45
150	200	397	165	380	102	347	46
160	210	405	168	385	103	349	46
180	230	419	173	395	106	354	47
200	250	433	179	405	108	359	47
250	300	468	194	430	115	373	49
300	350	504	209	455	122	385	51



combination T-element 90° i elbow 90°

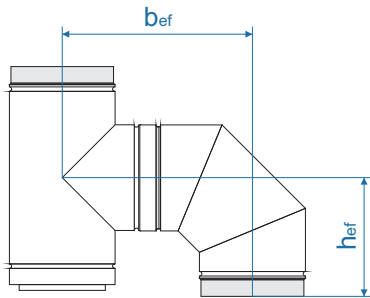

Inner diameter	Outer diameter	h _{ef}	b _{ef}
		100	150
130	180	182	372
150	200	192	392
160	210	197	402
180	230	207	422
200	250	217	442
250	300	242	492
300	350	267	542



combination T-element 45° and elbow 90°

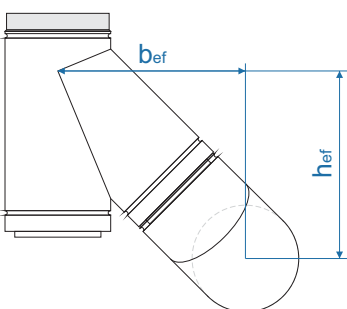

Inner diameter	Outer diameter	h _{ef}	b _{ef}
		100	150
130	180	353	353
150	200	377	377
160	210	389	389
180	230	413	413
200	250	437	437
250	300	497	497
300	350	558	558



combination T-element 45° i elbow 45°

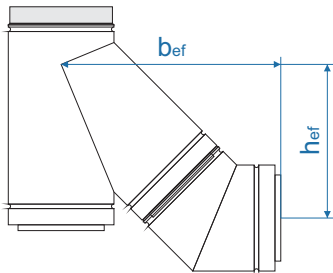

Inner diameter	Outer diameter		
		h_{ef}	b_{ef}
100	150	256	387
130	180	286	423
150	200	306	447
160	210	316	460
180	230	336	384
200	250	356	508
250	300	405	567
300	350	456	628

combination elbow 90° i elbow 45°

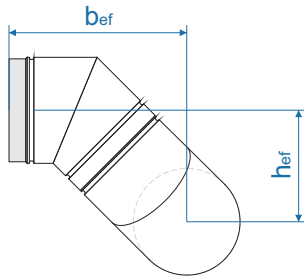

Inner diameter	Outer diameter		
		h_{ef}	b_{ef}
100	150	211	292
130	180	226	313
150	200	236	327
160	210	240	334
180	230	250	348
200	250	260	362
250	300	286	398
300	350	311	433



length elements

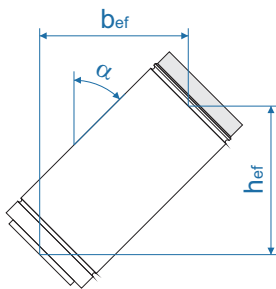

diameter	length (mm)	60°		45°		30°		15°	
		h_{ef}	b_{ef}	h_{ef}	b_{ef}	h_{ef}	b_{ef}	h_{ef}	b_{ef}
all	250	100	173	141	141	173	100	193	52
all	500	225	390	318	318	390	225	435	117
all	625	288	498	407	407	498	288	555	149
all	1000	475	823	672	672	823	475	918	246
all	1250	600	1039	849	849	1039	600	1159	311

Chimney kits



**Basic package
Kit A**

Hanging chimney with soot pot and supporting wall brackets.
Without cap nad flashing

Classification

T600-N1-D-Vm-L50050-G(50)

T600-N1-W-Vm-L50050-O(50)

**Composition of
package**

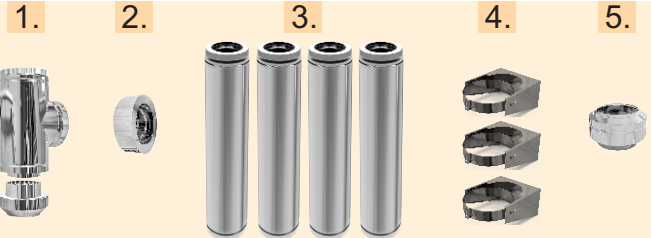

**Chimney type
PT25**

	Cat. nr.	Part name	Qty.
1	Ptr10xx	T-element with soot pot	1pcs
2	Ptp16xx	Adapter female	1pcs
3	Ptd10xx	Length element L=1000mm	4pcs
4	Ptn10xx	Wall bracket supporting 2-15cm	3pcs
5	Ptz11xx	Top stub flat	1pcs

Quality

		thickness	material
	Inner	0,5mm	1.4404
	Outer	0,5mm	1.4301
	Insulation	25mm	ceramic fiber

Packaging

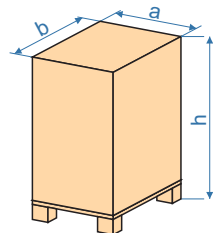

	inner φ	outer φ	total weight	a	b	h
	100	150	31,90kg	500	620	1100
	130	180	36,70kg	500	620	1100
	150	200	40,50kg	500	620	1100
	160	210	42,60kg	500	620	1100
	180	230	48,00kg	500	750	1100
	200	250	51,40kg	500	750	1100

Price

Kit A

	inner φ	outer φ	Price wsp.
1	100	150	493,-
2	130	180	550,-
3	150	200	605,-
4	160	210	631,-
5	180	230	662,-
6	200	250	761,-

	length ele. 1m	length ele. 0,5m	wall bracket	flashing 10°-35°	Rain cap	Rain and wind cap	elbow 90°
	cat. nr.	Ptd50xx	Ptn10xx	Pto11xx	Ptz50xx	Ptz20xx	Ptk90xx
Surcharge for additional elements (wsp.)	Ptd10xx	65,-	31,-	82,-	30,-	65,-	118,-
		67,-	32,-	86,-	32,-	67,-	120,-
		76,-	33,-	102,-	35,-	70,-	127,-
		80,-	35,-	102,-	37,-	72,-	140,-
		85,-	35,-	130,-	39,-	76,-	143,-
		103,-	64,-	39,-	130,-	44,-	86,-

Chimney kits



**Basic package
Kit B**

Hanging chimney with soot pot and supporting wall brackets.
Horizontal smoke output

Classification

T600-N1-D-Vm-L50050-G(50)
T600-N1-W-Vm-L50050-O(50)

**Composition of
package**

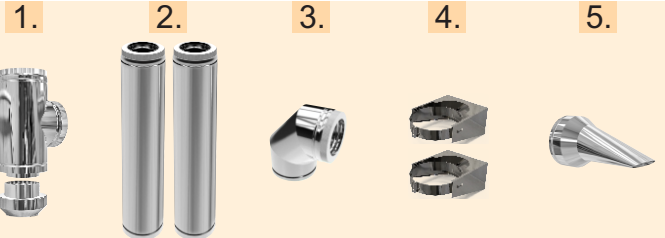

**Chimney type
PT25**

	Cat. nr.	Part name	Qty.
1	Ptr10xx	T-element with soot pot	1pcs
2	Ptd10xx	Length element L=1000mm	2pcs
3	Ptn10xx	Wall bracket supporting 2-15cm	2pcs
4	Ptk90xx	Elbow 90°	1pcs
5	Ptz30xx	Terminal cap for horizontal lining	1pcs

Quality

		thickness	material
	Inner	0,5mm	1.4404
	Outer	0,5mm	1.4301
	Insulation	25mm	ceramic fiber

Packaging

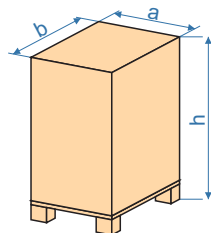

	inner φ	outer φ	total weight	a	b	h
	100	150	20,80kg	500	620	1100
	130	180	26,30kg	500	620	1100
	150	200	29,40kg	500	620	1100
	160	210	29,70kg	500	620	1100
	180	230	33,50kg	500	620	1100
	200	250	35,90kg	500	620	1100

Price

Kit B

	inner φ	outer φ	Price wsp
1	100	150	452,-
2	130	180	509,-
3	150	200	552,-
4	160	210	583,-
5	180	230	607,-
6	200	250	686,-

	length ele. 1m	length ele. 0,5m	length ele. 0,25m	wall bracket	flashing 10-35°	elbow 90°
cat. nr.	Ptd10xx	Ptd50xx	Ptd20xx	Ptn10xx	Pto11xx	Ptk90xx
Surcharge for additional elements (wsp.)	65,-	40,-	35,-	31,-	82,-	118,-
	67,-	42,-	36,-	32,-	86,-	120,-
	76,-	46,-	39,-	33,-	102,-	127,-
	80,-	50,-	40,-	35,-	102,-	140,-
	85,-	53,-	44,-	35,-	130,-	143,-
	103,-	64,-	53,-	39,-	130,-	165,-

Chimney kits



Basic package
Kit C

Hanging chimney with soot pot and supporting wall brackets. With rain and wind cap and with flashing

Classification

T600-N1-D-Vm-L50050-G(50)

T600-N1-W-Vm-L50050-O(50)

Composition of package

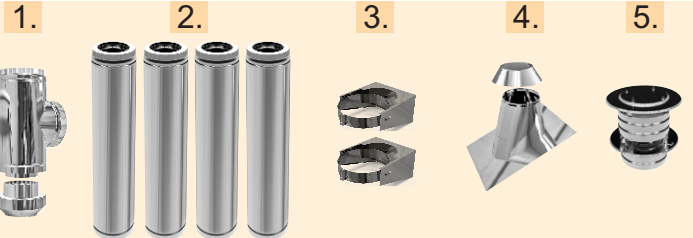

Chimney type
PT25

	Cat. nr.	Part name	Qnt.
1	Ptr10xx	T-element with soot pot	1pcs
2	Ptd10xx	Length element L=1000mm	4pcs
3	Ptn10xx	Wall bracket supporting 2-15cm	2pcs
4	Pto11xx	Flashing 10-35°	1pcs
5	Ptz20xx	Rain and wind cap	1pcs

Quality

		thickness	material
	Inner	0,5mm	1.4404
	Outer	0,5mm	1.4301
	Insulation	25mm	ceramic fiber

Packaging

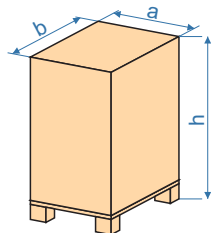

	inner φ	outer φ	total weight	a	b	h
	100	150	32,00kg	500	620	1500
	130	180	38,40kg	500	620	1500
	150	200	42,50kg	500	620	1500
	160	210	44,20kg	500	620	1500
	180	230	49,40kg	500	750	1500
	200	250	52,90kg	500	750	1500

Price

Kit C

	inner φ	outer φ	Price wsp.
1	100	150	562,-
2	130	180	621,-
3	150	200	690,-
4	160	210	714,-
5	180	230	772,-
6	200	250	866,-

	length ele. 1m	length ele. 0,5m	wall bracket 5-10cm	elbow 90°	rosette 70mm conical	plate rosette 0-40°	Adapter female	
	cat. nr.	Ptd10xx	Ptd50xx	Ptn10xx	Ptk90xx	Ptu10xx	Ptu30xx	Ptp16xx
Surcharge for additional elements (wsp.)		65,-	40,-	31,-	118,-	15,-	32,-	17,-
		67,-	42,-	32,-	120,-	15,-	34,-	18,-
		76,-	46,-	33,-	127,-	16,-	34,-	19,-
		80,-	50,-	35,-	140,-	16,-	34,-	19,-
		85,-	53,-	35,-	143,-	16,-	38,-	21,-
		103,-	64,-	39,-	165,-	18,-	42,-	23,-

Chimney kits



Basic package
Kit D

Chimney kit for floor stand or wall support without fastening elements, length elements or cap

Classification

T600-N1-D-Vm-L50050-G(50)
T600-N1-W-Vm-L50050-O(50)

Composition of package



Chimney type
PT25

	Cat. nr.	Part name	Qty.
1	Pts30xx	Inspection element with drain	1pcs
2	Ptc10xx	Inspection element with door h _{ef} =450mm	1pcs
3	Ptr20xx	T-element 90° h _{ef} =450mm	1pcs
4	Ptp18xx	Adapter double layer female	1pcs
5	Ptu10xx	Rosette 70mm conical tightable	1pcs
6	Ptz11xx	Top stub flat	1pcs

Quality

		thickness	material
	Inner	0,5mm	1.4404
	Outer	0,5mm	1.4301
	Insulation	25mm	ceramic fiber

Packaging

	inner φ	outer φ	total weight	a	b	h
	100	150	11,50kg	420	680	320
	130	180	13,80kg	420	680	320
	150	200	15,30kg	420	680	320
	160	210	15,80kg	520	680	370
	180	230	17,40kg	520	680	370
	200	250	19,00kg	520	680	370

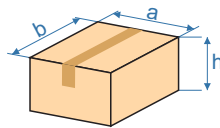

Price

Kit D												
inner φ	outer φ	Price wsp.	cat. nr.	length ele. 1m	length ele. 0,5m	wall bracket 5-10cm	wall bracket 10-20cm	flashing 10-35°	wall support 500	rain cap	rain and wind cap	
				Ptd10xx	Ptd50xx	Ptn20xx	Ptn21xx	Pto11xx	Ptn4050	Ptz50xx	Ptz20xx	
1	100	150	375,-	Surcharge for additional elements (wsp.)	65,-	40,-	36,-	43,-	69,-	30,-	65,-	
2	130	180	382,-		67,-	42,-	38,-	46,-		86,-	32,-	67,-
3	150	200	405,-		76,-	46,-	39,-	47,-		102,-	35,-	70,-
4	160	210	422,-		80,-	50,-	40,-	47,-		102,-	37,-	72,-
5	180	230	463,-		85,-	53,-	42,-	49,-		130,-	39,-	76,-
6	200	250	512,-		103,-	64,-	43,-	53,-		130,-	44,-	86,-

Chimney kits



Basic package
Kit E

Hanging chimney for a direct connector without a t-element, the connector is sliding - for simple disassembly

Classification

T600-N1-D-Vm-L50050-G(50)

T600-N1-W-Vm-L50050-O(50)

Composition of package

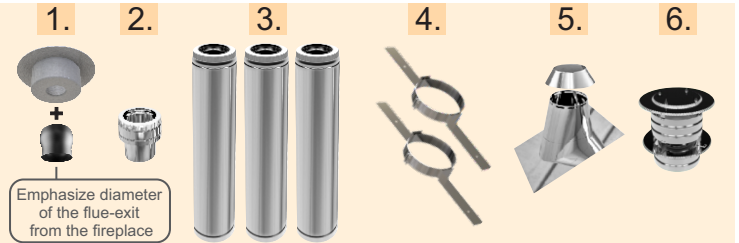

Chimney type
PT25

	Cat. nr.	Part name	Qty.
1	Ptu40xx	Ceiling cover + sliding reducer	1pcs
2	Ptp10xx	Adapter SW-DW	1pcs
3	Ptd10xx	Length element L=1000mm	3pcs
4	Ptn30xx	Plate bracket	2pcs
5	Pto11xx	Flashing 10-35°	1pcs
6	Ptz20xx	Rain and wind cap	1pcs

Quality

	thickness	material
Inner wall	0,5mm	1.4404
Outer wall	0,5mm	1.4301
Insulation	25mm	ceramic fiber

Packaging

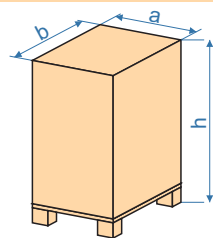

	inner φ	outer φ	total weight	a	b	h
	100	150	25,20kg	500	620	1100
	130	180	31,10kg	500	620	1100
	150	200	33,30kg	500	620	1100
	160	210	34,80kg	500	620	1100
	180	230	39,10kg	500	750	1100
	200	250	40,90kg	500	750	1100

Price

Kit E

	inner φ	outer φ	Price wsp.
1	100	150	487,-
2	130	180	509,-
3	150	200	564,-
4	160	210	583,-
5	180	230	646,-
6	200	250	723,-

	length ele. 1m	length ele. 1m	wall bracket	elbow 30° 2pcs	Wall rosete 70mm conical	Plate rosette 0-40°	Inspection length
cat. nr.	Ptd10xx	Ptd50xx	Ptn10xx	Ptk30xx	Ptu10xx	Ptu30xx	Ptc10xx
Surcharge for additional elements (wsp.)	65,-	40,-	31,-	102,-	15,-	32,-	152,-
	67,-	42,-	32,-	106,-	15,-	34,-	153,-
	76,-	46,-	33,-	114,-	16,-	34,-	156,-
	80,-	50,-	35,-	124,-	16,-	34,-	159,-
	85,-	53,-	35,-	196,-	16,-	38,-	162,-
	103,-	64,-	39,-	204,-	18,-	42,-	183,-

Price in €

Chimney kits



**Basic package
Kit F**

Hanging chimney with a pot for collecting of soot and 2 elbows 30° to bypass the roof.

Classification

T600-N1-D-Vm-L50050-G(50)
T600-N1-W-Vm-L50050-O(50)

Composition of package

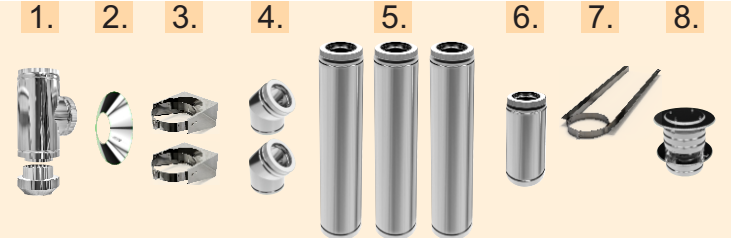

**Chimney type
PT25**

	Cat. nr.	Part name	Qty.
1	Ptr10xx	T-element with soot pot	1pcs
2	Ptu10xx	Wall rosette 70mm conical	1pcs
3	Ptn10xx	Wall bracket - supporting 3-15	2pcs
4	Ptk30xx	Elbow 30°	2pcs
5	Ptd10xx	Length element L=1000mm	3pcs
6	Ptd50xx	Length element L=500mm	1pcs
7	Ptn31xx	Place bracket	1pcs
8	Ptz20xx	Rain and wind cap	1pcs

Quality

	thickness	material
Inner wall	0,5mm	1.4404
Outer wall	0,5mm	1.4301
Insulation	25mm	ceramic fiber

Packaging

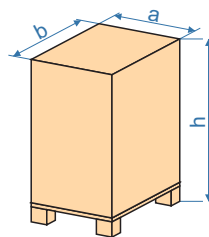

	inner φ	outer φ	total weight	a	b	h
	100	150	30,60kg	420	680	1100
	130	180	38,40kg	420	680	1100
	150	200	41,60kg	420	680	1100
	160	210	44,10kg	520	680	1100
	180	230	49,00kg	520	680	1100
	200	250	51,80kg	520	680	1100

Price

Kit F

	inner φ	outer φ	Price wsp.
1	100	150	615,-
2	130	180	677,-
3	150	200	736,-
4	160	210	772,-
5	180	230	812,-
6	200	250	965,-

	length ele. 1m	length ele. 0,5m	length ele. 0,25m	wall bracket	flashing 10-35°
cat. nr.	Ptd10xx	Ptd50xx	Ptd20xx	Ptn10xx	Pto11xx
Surcharge for additional elements (wsp.)	65,-	40,-	35,-	31,-	82,-
	67,-	42,-	36,-	32,-	86,-
	76,-	46,-	39,-	33,-	102,-
	80,-	50,-	40,-	35,-	102,-
	85,-	53,-	44,-	35,-	130,-
	103,-	64,-	53,-	39,-	130,-

Extension of wall chimneys

Basic package
Kit G

Kit for extending masonry chimneys

Classification

T600-N1-D-Vm-L50050-G(50)

T600-N1-W-Vm-L50050-O(50)

Basic parts of wall chimney extensions:

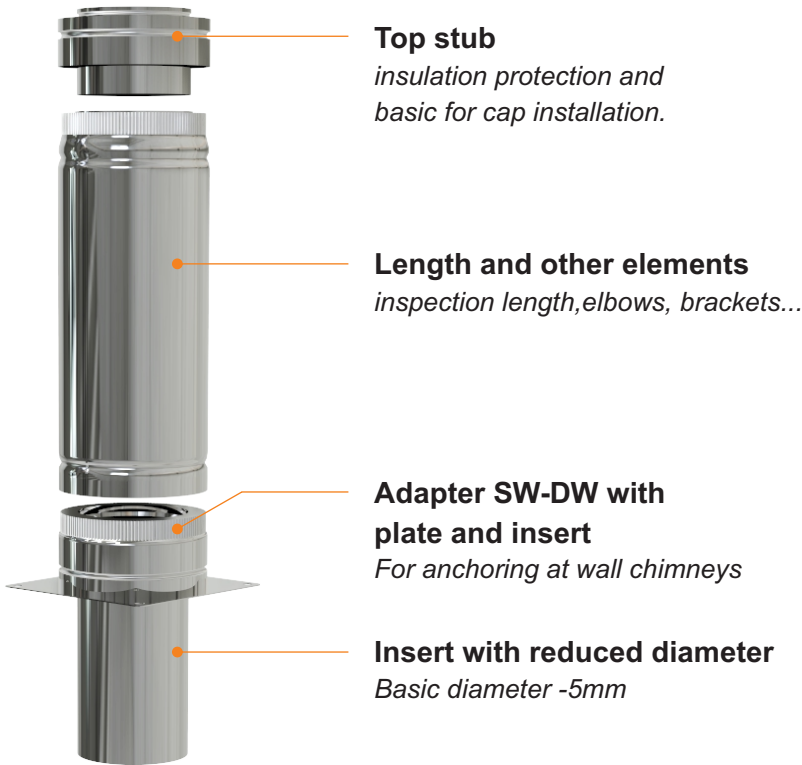

Transition SW-DW trouble
elements for anchoring at wall chimneys
In relation to SW-DW with plate, price is acceptable and it have to be pour with concrete approximately 5cm of thickness. Example is shown at the image on the left side.





Fixing kit with 2 rods
Unlike wires where it is necessary at least 3 arms, rods are possible to mount only with 2 arms with mutual angle of 70-120° (ideally 90°). It is used when the chimney passes above of the last fixation more than 3m or if fixation under the roof is not satisfying.

Proposed prices of basic kit for extension of wall chimneys

Kit elements G-1



1.  2.  3. 



	Cat nr.	Article name	Qty.
1	Ptp20xx	Adapter SW-DW with bottom plate	1kom
2	Ptd10xx	Length element L=1000mm	1kom
3	Ptz11xx	Top stub flat	1kom

Price
Kit G1

	inner φ	outer φ	Price wsp.
1	100	150	123,-
2	130	180	130,-
3	150	200	143,-
4	160	210	150,-
5	180	230	158,-
6	200	250	182,-

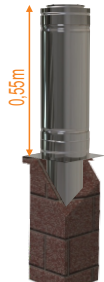
Kit elements G-2



1.  2.  3. 



	Cat nr.	Article name	Qty.
1	Ptp20xx	Adapter SW-DW with bottom plate	1kom
2	Ptd50xx	Length element L=500mm	1kom
3	Ptz11xx	Top stub flat	1kom

Price
Kit G2

	inner φ	outer φ	Price wsp.
1	100	150	98,-
2	130	180	105,-
3	150	200	113,-
4	160	210	120,-
5	180	230	126,-
6	200	250	143,-

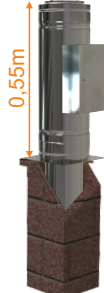
Kit elements G-3













1.  2.  3. 

	Cat nr.	Article name	Qty.
1	Ptp20xx	Adapter SW-DW with bottom plate	1kom
2	Ptc10xx	Inspection length L=500mm	1kom
3	Ptz11xx	Top stub flat	1kom

Price
Kit G3

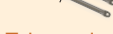

	inner φ	outer φ	Price wsp.
1	100	150	210,-
2	130	180	216,-
3	150	200	223,-
4	160	210	229,-
5	180	230	235,-
6	200	250	262,-

Surcharge for additional elements (wsp.)	inner φ											
		length el. 1m	length el. 0,5m	length el. 0,25m	Floor bracket	elbow 30° 2pcs	flashing 10-35°	Rain cap	Rain and wind cap	Bracket for static rod (for rod and wires)	Telescoping rod 3,0m	Plate for telescoping rods for roof tile cover (2pcs)
		Ptd10xx	Ptd50xx	Ptd20xx	Ptn30xx	Ptk30xx	Pto11xx	Ptz50xx	Ptz20xx	Ptn50xx	Ptn5230	Ptn5321
1	100	65,-	40,-	35,-	32,-	102,-	82,-	30,-	65,-	19,-	140,-	40,-
2	130	67,-	42,-	36,-	33,-	106,-	86,-	32,-	67,-	19,-		
3	150	76,-	46,-	39,-	34,-	114,-	102,-	35,-	70,-	20,-		
4	160	80,-	50,-	40,-	35,-	124,-	102,-	37,-	72,-	20,-		
5	180	85,-	53,-	44,-	38,-	196,-	130,-	39,-	76,-	20,-		
6	200	103,-	64,-	53,-	41,-	204,-	130,-	44,-	86,-	21,-		



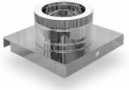

Price in €

Inner wall diameter mm	100	130	150	160	180	200	250	300
Outer wall diameter mm	150	180	200	210	230	250	300	350
Inner wall thickness mm	0,50	0,50	0,50	0,50	0,50	0,50	0,50	0,50





Inspection lengths and Bottom plates

	Inspection length with door d=500mm hef=450mm	Cat. Nr.	Ptc1010	Ptc1013	Ptc1015	Ptc1016	Ptc1018	Ptc1020	Ptc1025	Ptc1030
		Price	152,00	153,00	156,00	159,00	162,00	183,00	198,00	220,00
	Kombi-T-element, inspection length d=500mm ef=450mm	Cat. Nr.	Pts2010	Pts2013	Pts2015	Pts2016	Pts2018	Pts2020		
		Price	247,00	248,00	259,00	289,00	302,00	339,00		
	Kombi-T-element, inspection length d=625mm hef=575mm	Cat. Nr.						Pts2120	Pts2125	Pts2130
		Price						373,00	403,00	448,00
	Bottom plate with drain floor and wall installation d=100mm hef=50mm	Cat. Nr.	Pts3010	Pts3013	Pts3015	Pts3016	Pts3018	Pts3020	Pts3025	Pts3030
		Price	40,00	42,00	44,00	45,00	48,00	50,00	69,00	85,00



T-elements

	T-element 90° d=500mm hef=450mm	Cat. Nr.	Ptr2010	Ptr2013	Ptr2015	Ptr2016	Ptr2018	Ptr2020	Ptr2025	
		Price	80,00	80,00	88,00	95,00	125,00	139,00	170,00	
	T-element 90° d=650mm hef=600mm	Cat. Nr.							Ptr2125	Ptr2130
		Price							185,00	206,00
	T-element 45° d=500mm hef=450mm	Cat. Nr.	Ptr4010	Ptr4013	Ptr4015	Ptr4016	Ptr4018			
		Price	105,00	105,00	115,00	150,00	153,00			
	T-element 45° d=650mm hef=600mm	Cat. Nr.						Ptr4120	Ptr4125	Ptr4130
		Price						175,00	225,00	270,00

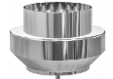
T-elements with soot pot

	T-elements with soot pot 90° d=500mm hef=200mm	Cat. Nr.	Ptr1010	Ptr1013	Ptr1015	Ptr1016	Ptr1018	Ptr1020		
		Price	93,00	136,00	148,00	150,00	159,00	170,00		
	T-element with soot pot 90° d=650mm hef=600mm	Cat. Nr.							Ptr1125	Ptr1130
		Price							192,00	215,00
	T-element with soot pot 45° d=500mm hef=200mm	Cat. Nr.	Ptr3010	Ptr3013	Ptr3015	Ptr3016	Ptr3018			
		Price	121,00	179,00	192,00	204,00	207,00			
	T-element with soot pot 45° d=650mm hef=600mm	Cat. Nr.						Ptr3120	Ptr3125	Ptr3130
		Price						219,00	269,00	328,00
	Soot pot with drain h=250mm	Cat. Nr.	Ptc1010	Ptc1013	Ptc1015	Ptc1016	Ptc1018	Ptc1020	Ptc1025	Ptc1030
		Price	15,00	18,00	20,00	21,00	23,00	24,00	29,00	33,00

Transitions

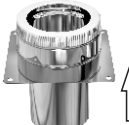
	Transition SW-DW h=250mm	Cat. Nr.	Ptp1010	Ptp1013	Ptp1015	Ptp1016	Ptp1018	Ptp1020	Ptp1025	Ptp1030
		Price	24,00	26,00	27,00	28,00	32,00	37,00	48,00	58,00
	Transition SW-DW with bottom plate h=330mm	Cat. Nr.	Ptp2010	Ptp2013	Ptp2015	Ptp2016	Ptp2018	Ptp2020	Ptp2025	Ptp2030
		Price	28,00	31,00	32,00	33,00	36,00	40,00	55,00	63,00
	Transition SW-DW to be poured in concret h=330mm	Cat. Nr.	Ptp3010	Ptp3013	Ptp3015	Ptp3016	Ptp3018	Ptp3020	Ptp3025	Ptp3030
		Price	25,00	27,00	28,00	29,00	33,00	38,00	49,00	59,00
	Transition reduced reduced up to 20mm h=330mm	Cat. Nr.	Ptp2110	Ptp2113	Ptp2115	Ptp2116	Ptp2118	Ptp2120	Ptp2125	Ptp2130
		Price	28,00	31,00	32,00	33,00	36,00	40,00	55,00	63,00
	Transition reduced reduced up to 20mm h=330mm	Cat. Nr.	Ptp3110	Ptp3113	Ptp3115	Ptp3116	Ptp3118	Ptp3120	Ptp3125	Ptp3130
		Price	25,00	27,00	28,00	29,00	33,00	38,00	49,00	59,00

Inner wall diameter mm	100	130	150	160	180	200	250	300
Outer wall diameter mm	150	180	200	210	230	250	300	350
Inner wall thickness mm	0,50	0,50	0,50	0,50	0,50	0,50	0,50	0,50

	door depth effective height total height weight	b hef h m	mm mm mm kg	30 450 500 3,60	30 450 500 3,90	30 450 500 4,36	30 450 500 4,55	30 450 500 4,93	30 450 500 6,60	30 450 500 7,65	30 450 500 8,30
	height of t-connection depth of t-connection effective height total height weight	c a hef h m	mm mm mm mm kg	250 100 450 500 4,19	250 100 450 500 5,11	250 100 450 500 5,75	250 100 450 500 6,07	250 100 450 500 6,74	312 100 450/575 500/625 7,30/8,50	312 100 575 625 9,22	312 100 575 625 11,14
	total height effective height side of plate weight	h hef f m	mm mm mm kg	140 90 200 1,40	140 90 230 1,80	140 90 250 2,10	140 90 260 2,40	140 90 280 2,60	140 90 300 2,90	140 90 350 3,70	140 90 400 4,70

	height of t-connection depth of t-connection effective height total height weight	c a hef h m	mm mm mm mm kg	250 100 450 500 3,29	250 100 450 500 4,18	250 100 450 500 4,79	250 100 450 500 5,10	250 100 450 500 5,74	312 100 450/575 500/625 6,39	312 100 575 625 8,08	312 100 575 625 9,86
	height of t-connection depth of t-connection effective height total height shear weight	b a hef h c m	mm mm mm mm mm kg	126 324 450 500 199 3,86	116 334 450 500 224 5,01	109 341 450 500 242 5,82	105 345 450 500 250 6,24	98 352 450 500 267 8,25	153 422 575 625 284 9,27	136 439 575 625 327 11,96	306 644 950 1000 370 19,15

	min.height of t-conn. height of t-connection effective height total height weight	c b hef h m	mm mm mm mm kg	460 350 200 600 3,80	460 350 200 600 4,90	460 350 200 600 6,20	460 350 200 600 5,70	460 350 200 600 6,40	460/522 350/412 200/262 600/725 7,30	522 412 262 725 11,96	522 412 262 725 19,15
	min.height of t-conn. height of t-connection effective height total height weight	c b hef h m	mm mm mm mm kg	460 350 200 600 4,88	460 350 200 600 6,28	460 350 200 600 7,25	460 350 200 600 7,76	460 350 200 600 9,93	460/522 350/412 200/262 600/725 11,11	522 412 262 725 14,22	522 412 262 725 21,82
	effective height total height weight	a h m	mm mm kg	200 160 1,02	200 160 1,27	200 160 1,43	200 160 1,52	200 160 1,68	200 160 1,84	200 160 2,26	200 160 2,67

	total height outer insert diameter insert depth weight	a b c m	mm mm mm kg	250 100 150 1,20	250 130 150 1,40	250 150 150 1,60	250 160 150 1,70	250 180 150 1,80	250 200 150 2,10	250 250 150 1,51	250 300 150 1,81
	total height outer insert diameter insert depth plate width weight	a b c d m	mm mm mm mm kg	330 95 230 270 1,80	330 125 230 300 2,20	330 145 230 320 2,31	330 155 230 330 2,70	330 175 230 350 3,00	330 195 230 370 3,09	330 245 230 420 3,90	330 295 230 470 4,84
	total height outer insert diameter insert depth prong length weight	a b c d m	mm mm mm mm kg	330 95 230 60 1,30	330 125 230 60 1,40	330 145 230 60 1,50	330 155 230 60 1,60	330 175 230 60 1,70	330 195 230 60 1,90	330 245 230 60 1,5	330 295 230 60 1,5

Price in €

Inner wall diameter mm	100	130	150	160	180	200	250	300
Outer wall diameter mm	150	180	200	210	230	250	300	350
Inner wall thickness mm	0,50	0,50	0,50	0,50	0,50	0,50	0,50	0,50

Length elements



Length element d=1250mm hef=1200mm	Cat. Nr.							Ptd1225	Ptd1230
	Price							170,00	208,00
Length element d=1000mm hef=950mm	Cat. Nr.	Ptd1010	Ptd1013	Ptd1015	Ptd1016	Ptd1018	Ptd1020	Ptd1025	Ptd1030
	Price	65,00	67,00	76,00	80,00	85,00	103,00	132,00	159,00
Length element d=500mm hef=450mm	Cat. Nr.	Ptd5010	Ptd5013	Ptd5015	Ptd5016	Ptd5018	Ptd5020	Ptd5025	Ptd5030
	Price	40,00	42,00	46,00	50,00	53,00	64,00	76,00	97,00
Length element d=250mm hef=200mm	Cat. Nr.	Ptd2010	Ptd2013	Ptd2015	Ptd2016	Ptd2018	Ptd2020	Ptd2025	Ptd2030
	Price	35,00	36,00	39,00	40,00	44,00	53,00	65,00	76,00

Length element - cuttable



Length element Cuttable 1250	Cat. Nr.							Ptm1225	Ptm1230
	Price							225,00	270,00
Length element Cuttable 1000	Cat. Nr.	Ptm1010	Ptm1013	Ptm1015	Ptm1016	Ptm1018	Ptm1020	Ptm1025	Ptm1030
	Price	86,00	86,00	98,00	105,00	111,00	135,00	171,00	208,00
Length element Cuttable 500	Cat. Nr.	Ptm5010	Ptm5013	Ptm5015	Ptm5016	Ptm5018	Ptm5020	Ptm5025	Ptm5030
	Price	48,00	48,00	54,00	58,00	60,00	72,00	87,00	112,00

Length element supporting

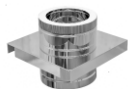

Length element with supporting plate (combination with console plate)	Cat. Nr.	Ptm5010	Ptm5013	Ptm5015	Ptm5016	Ptm5018	Ptm5020	Ptm5025	Ptm5030
	Price	46,00	52,00	56,00	58,00	64,00	70,00	84,00	92,00

Connection Adapters

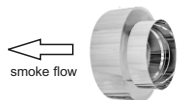

Adapter
SW-DW for stove connection
connection diameter same as chimney diameter

Cat. Nr.	Ptp1510	Ptp1513	Ptp1515	Ptp1516	Ptp1518	Ptp1520	Ptp1525	Ptp1530
Price	17,00	18,00	19,00	19,00	21,00	23,00	25,00	28,00

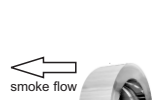

Adapter reduced male
SW-DW for stove connection
connection diameter same as chimney diameter

Cat. Nr.	Ptp1610	Ptp1613	Ptp1615	Ptp1616	Ptp1618	Ptp1620	Ptp1625	Ptp1630
Price	17,00	18,00	19,00	19,00	21,00	23,00	25,00	28,00



Adapter reduced female
SW-DW for stove connection
diameter for stove connection have to be specified when ordering

Cat. Nr.	Ptp1710	Ptp1713	Ptp1715	Ptp1716	Ptp1718	Ptp1720	Ptp1725	Ptp1730
Price	17,00	18,00	19,00	19,00	21,00	23,00	25,00	28,00



Adapter double layer female
SW-DW match at cutted length element
connection diameter same as chimney diameter

Cat. Nr.	Ptp1810	Ptp1813	Ptp1815	Ptp1816	Ptp1818	Ptp1820	Ptp1825	Ptp1830
Price	58,00	60,00	66,00	70,00	75,00	83,00	105,00	123,00

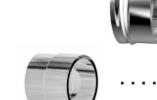

Double sleeve SD-M to CN1
Transition from SD-M system to CN1 F-F
connection diameter same as chimney diameter

Cat. Nr.	Ptp1910	Ptp1913	Ptp1915	Ptp1916	Ptp1918	Ptp1920	Ptp1925	Ptp1930
Price	17,00	18,00	18,00	18,00	19,00	19,00	20,00	21,00

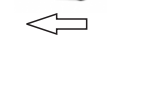

Double wall neck
500mm

Cat. Nr.	Ptf2010	Ptf2013	Ptf2015	Ptp2016	Ptp2018	Ptf2020	Ptf2025	Ptf2030
Price	25,00	27,00	28,00	29,00	30,00	32,00	35,00	39,00



Length element SW type CN1
cuttable
330mm

Cat. Nr.	Cn1d3310	Cn1d3313	Cn1d3315	Cn1d3316	Cn1d3318	Cn1d3320	Cn1d3325	Cn1d3330
Price	15,00	17,00	18,00	18,00	19,00	19,00	21,00	23,00



Length element SW type CN1
cuttable
500mm

Cat. Nr.	Cn1d5010	Cn1d5013	Cn1d5015	Cn1d5016	Cn1d5018	Cn1d5020	Cn1d5025	Cn1d5030
Price	17,00	20,00	21,00	21,00	22,00	23,00	26,00	29,00



Length element SW type CN1
cuttable
1000mm

Cat. Nr.	Cn1d1010	Cn1d1013	Cn1d1015	Cn1d1016	Cn1d1018	Cn1d1020	Cn1d1025	Cn1d1030
Price	22,00	27,00	29,00	30,00	32,00	34,00	40,00	45,00

Inner wall diameter mm	100	130	150	160	180	200	250	300
Outer wall diameter mm	150	180	200	210	230	250	300	350
Inner wall thickness mm	0,50	0,50	0,50	0,50	0,50	0,50	0,50	0,50

	effective height	hef	mm							1200	1200
	total height	h	mm							1250	1250
	weight	m	kg							13,80	17,00
	effective height	hef	mm	950	950	950	950	950	950	950	950
total height	h	mm	1000	1000	1000	1000	1000	1000	1000	1000	
weight	m	kg	4,80	6,40	6,80	7,10	8,30	8,60	11,10	13,80	
effective height	hef	mm	450	450	450	450	450	450	450	450	
total height	h	mm	500	500	500	500	500	500	500	500	
weight	m	kg	2,50	3,60	3,40	4,10	4,50	4,60	6,10	7,00	
effective height	hef	mm	200	200	200	200	200	200	200	200	
total height	h	mm	250	250	250	250	250	250	250	250	
weight	m	kg	1,40	2,00	2,50	2,00	2,00	2,40	3,20	3,80	

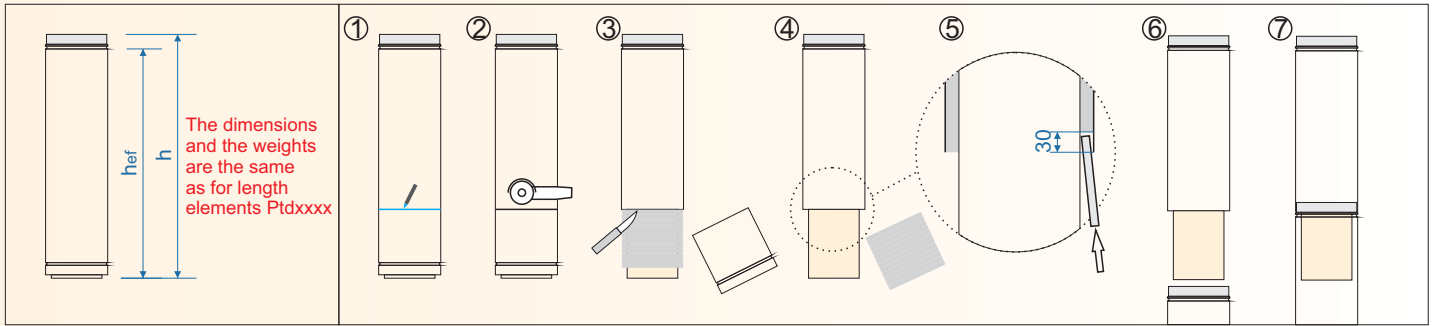

	effective height	hef	mm	250	250	250	250	250	250	250	250
	total height	h	mm	200	200	200	200	200	200	200	200
plate side	f	mm	230	260	280	290	310	330	380	430	
weight	m	kg	1,50	1,90	2,10	2,50	2,70	3,0	3,80	4,80	

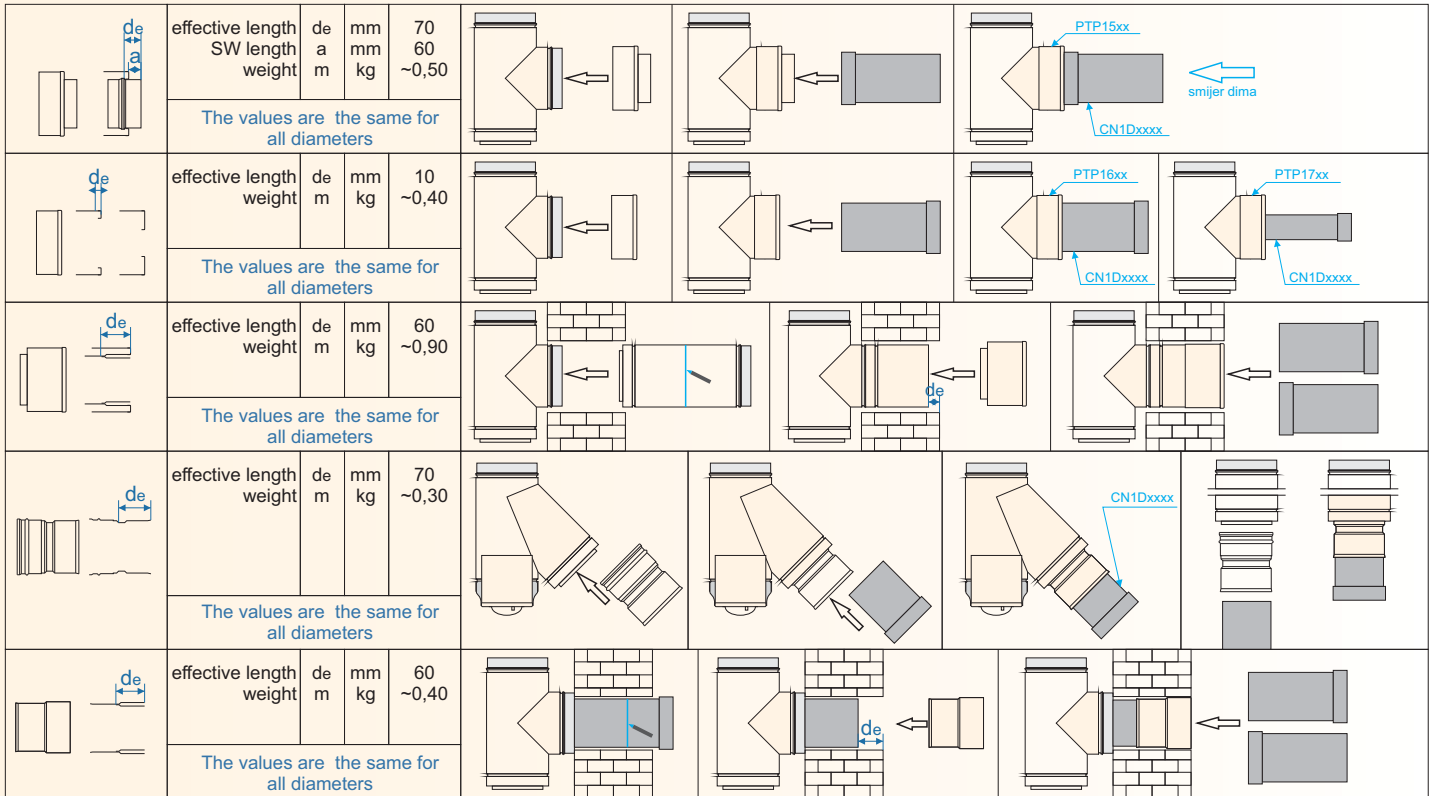

Price in €

Inner wall diameter mm

100

130

150

160

180

200

250

300

Outer wall diameter mm

150

180

200

210

230

250

300

350

Inner wall thickness mm

0,50

0,50

0,50

0,50

0,50

0,50

0,50

0,50

Elbows



Elbow 3-sections
90°

Cat. Nr.	Ptk9010	Ptk9013	Ptk9015	Ptk9016	Ptk9018	Ptk9020	Ptk9025	Ptk9030
Price	118,00	120,00	127,00	140,00	143,00	165,00	189,00	209,00



Elbow 90° with inspection door

Cat. Nr.	Ptk9110	Ptk9113	Ptk9115	Ptk9116	Ptk9118	Ptk9120	Ptk9125	Ptk9130
Price	129,00	132,00	139,00	154,00	157,00	181,00	207,00	229,00



Elbow 3-sections
60°

Cat. Nr.	Ptk6010	Ptk6013	Ptk6015	Ptk6016	Ptk6018	Ptk6020	Ptk6025	Ptk6030
Price	56,00	58,00	63,00	70,00	74,00	97,00	112,00	119,00



Elbow 2-sections
45°

Cat. Nr.	Ptk4510	Ptk4513	Ptk4515	Ptk4516	Ptk4518	Ptk4520	Ptk4525	Ptk4530
Price	53,00	55,00	60,00	67,00	70,00	102,00	106,00	115,00



Elbow 2-sections
30°

Cat. Nr.	Ptk3010	Ptk3013	Ptk3015	Ptk3016	Ptk3018	Ptk3020	Ptk3025	Ptk3030
Price	51,00	53,00	57,00	62,00	67,00	98,00	102,00	109,00



Elbow 2-sections
15°

Cat. Nr.	Ptk1510	Ptk1513	Ptk1515	Ptk1516	Ptk1518	Ptk1520	Ptk1525	Ptk1530
Price	48,00	49,00	52,00	56,00	61,00	89,00	93,00	99,00

Terminals



Top stub flat

Cat. Nr.	Ptz1110	Ptz1113	Ptz1115	Ptz1116	Ptz1118	Ptz1120	Ptz1125	Ptz1130
Price	30,00	32,00	35,00	37,00	37,00	39,00	44,00	54,00



Top stub conical

Cat. Nr.	Ptz1010	Ptz1013	Ptz1015	Ptz1016	Ptz1018	Ptz1020	Ptz1025	Ptz1030
Price	30,00	32,00	35,00	37,00	37,00	39,00	44,00	54,00



Rain and wind cap

Cat. Nr.	Ptz2010	Ptz2013	Ptz2015	Ptz2016	Ptz2018	Ptz2020	Ptz2025	Ptz2030
Price	65,00	67,00	70,00	72,00	73,00	76,00	86,00	96,00

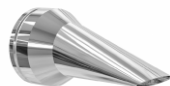

Terminal cap for horizontal installation
(requires elbow 90°)

Cat. Nr.	Ptz3010	Ptz3013	Ptz3015	Ptz3016	Ptz3018	Ptz3020	Ptz3025	Ptz3030
Price	49,00	55,00	59,00	63,00	65,00	67,00	75,00	85,00

Caps (requires top stub flat or top stub conical)



Rain cap

Cat. Nr.	Ptz5010	Ptz5013	Ptz5015	Ptz5016	Ptz5018	Ptz5020	Ptz5025	Ptz5030
Price	30,00	32,00	35,00	37,00	37,00	39,00	44,00	54,00



Rain cap with mesh
(protection from birds and sparks)

Cat. Nr.	Ptz5110	Ptz5113	Ptz5115	Ptz5116	Ptz5118	Ptz5120	Ptz5125	Ptz5130
Price	33,00	35,00	38,00	40,00	40,00	44,00	49,00	60,00



Louvers cap 2 louvers

Cat. Nr.	Ptz6010	Ptz6013	Ptz6015	Ptz6016	Ptz6018	Ptz6020	Ptz6025	Ptz6030
Price	49,00	55,00	59,00	63,00	65,00	67,00	75,00	85,00



Louvers cap 3 louvers

Cat. Nr.	Ptz6110	Ptz6113	Ptz6115	Ptz6116	Ptz6118	Ptz6120	Ptz6125	Ptz6130
Price	65,00	67,00	70,00	72,00	73,00	76,00	86,00	96,00



Louvers cap 2 louvers with mesh
(protection from birds and sparks)

Cat. Nr.	Ptz6210	Ptz6213	Ptz6215	Ptz6216	Ptz6218	Ptz6220	Ptz6225	Ptz6230
Price	54,00	59,00	64,00	68,00	70,00	72,00	79,00	89,00



Louvers cap 3 louvers with mesh
(protection from birds and sparks)

Cat. Nr.	Ptz6310	Ptz6313	Ptz6315	Ptz6316	Ptz6318	Ptz6320	Ptz6325	Ptz6330
Price	69,00	72,00	74,00	76,00	77,00	80,00	89,00	101,00

Inner wall diameter mm	100	130	150	160	180	200	250	300
Outer wall diameter mm	150	180	200	210	230	250	300	350
Inner wall thickness mm	0,50	0,50	0,50	0,50	0,50	0,50	0,50	0,50

	PtK90xx PtK91xx	effective width	bef	mm	167	182	192	197	207	217	242	267
		effective height	hef	mm	217	232	242	247	257	267	292	317
		effective width	aef	mm	217	232	242	247	257	267	292	317
		effective height	Hef	mm	167	182	192	197	207	217	242	267
		weight		m	kg	2,00	2,70	3,00	3,10	3,60	4,10	5,50
		weight		m	kg	3,40	4,20	4,90	5,40	6,10	7,50	9,20
	PtK60xx	effective width	bef	mm	111	118	123	126	131	136	148	161
		effective height	hef	mm	242	255	264	268	277	285	307	329
		effective width	aef	mm	154	162	167	169	174	179	192	204
		effective height	Hef	mm	217	230	239	243	252	260	282	304
		weight		m	kg	1,90	2,60	2,90	3,00	3,50	4,00	5,40
	PtK45xx	effective width	bef	mm	57	62	65	66	69	72	79	87
		effective height	hef	mm	188	199	206	210	217	224	241	259
		effective width	aef	mm	93	97	100	101	104	107	115	122
		effective height	Hef	mm	174	184	191	195	202	209	227	244
		weight		m	kg	1,50	1,70	2,10	2,30	2,50	2,90	3,50
	PtK30xx	effective width	bef	mm	35	37	38	39	40	42	45	48
		effective height	hef	mm	181	188	193	196	201	206	218	231
		effective width	aef	mm	60	62	63	64	65	67	70	73
		effective height	Hef	mm	174	182	187	189	194	199	212	224
		weight		m	kg	1,40	1,60	2,00	2,20	2,30	2,70	3,00
	PtK15xx	effective width	bef	mm	16	16	16	17	17	17	18	19
		effective height	hef	mm	168	172	174	175	178	181	187	194
		effective width	aef	mm	28	29	29	29	30	30	31	32
		effective height	Hef	mm	166	170	172	174	176	179	185	192
		weight		m	kg	1,30	1,50	1,80	1,90	2,10	2,20	2,70

	total height	h	mm	110	110	110	110	110	110	110	110
	weight	m	kg	0,40	0,50	0,50	0,60	0,70	0,80	1,11	1,38
	total height	h	mm	180	180	180	180	180	180	180	180
	weight	m	kg	0,60	0,80	1,00	1,00	1,10	1,20	1,80	2,18
	total weight	a	mm	250	280	300	310	330	350	400	450
	total height	h	mm	280	280	355	355	355	360	390	425
	effective height	hef	mm	125	125	125	125	125	125	125	125
	weight	m	kg	1,30	1,60	2,10	2,20	2,40	2,60	3,67	4,49
	effective length	a	mm	275	275	275	275	275	275	275	275
	weight	m	kg	1,40	1,70	2,10	2,30	2,70	3,30	5,00	6,90

	total height	h	mm	120	150	170	180	200	220	270	320
	total width	a	mm	220	250	270	280	300	320	370	420
	weight	m1	kg	0,30	0,30	0,30	0,40	0,50	0,50	0,70	0,80
	weight with mesh	m2	kg	0,50	0,50	0,60	0,70	0,90	1,20	1,50	1,80
	total height	h1	mm	256	256	256	256	256	256	256	256
	total height	h2	mm	325	325	325	325	325	325	325	325
	total width	a	mm	220	250	270	280	300	320	370	420
	weight (2 louvers)	m1	kg	0,70	0,90	0,90	0,90	1,00	1,10	1,30	1,50
	weight (3 louvers)	m2	kg	0,90	1,10	1,10	1,10	1,20	1,40	1,60	1,90
	total height	h1	mm	256	256	256	256	256	256	256	256
	total height	h2	mm	325	325	325	325	325	325	325	325
	total width	a	mm	220	250	270	280	300	320	370	420
	weight (2 louvers)	m1	kg	1,00	1,30	1,40	1,40	1,60	1,70	2,10	2,50
	weight (3 louvers)	m2	kg	1,40	1,80	2,00	2,10	2,20	2,50	3,10	3,70

Price in €

Inner wall diameter mm	100	130	150	160	180	200	250	300
Outer wall diameter mm	150	180	200	210	230	250	300	350
Inner wall thickness mm	0,50	0,50	0,50	0,50	0,50	0,50	0,50	0,50

Flashings

	Flashings stainless steel Universal 10-35°	Cat. Nr.	Pto1110	Ptd1113	Pto1115	Pto1116	Ptd1118	Pto1120	Pto1125	Pto1130
	Price	82,00	86,00	102,00	102,00	130,00	130,00	146,00	184,00	
	Flashings stainless steel For roof angle 35-45°	Cat. Nr.	Pto1210	Ptd1213	Pto1215	Pto1216	Ptd1218	Pto1220	Pto1225	Pto1230
	Price	82,00	86,00	102,00	102,00	130,00	130,00	146,00	184,00	
	Flashings stainless steel No angle (0°)	Cat. Nr.	Pto5010	Pto5013	Pto5015	Pto5016	Pto5018	Pto5020	Pto5025	Pto5030
	Price	77,00	81,00	97,00	97,00	125,00	125,00	140,00	180,00	
	Flashings stainless steel - Lead Universal 10-35°	Cat. Nr.	Pto9210	Pto9213	Pto9215	Pto9216	Pto9218	Pto9220	Pto9225	Pto9230
	Price	222,00	230,00	237,00	250,00	255,00	297,00	313,00	565,00	
	Flashings stainless steel - Lead For roof angle 35-45°	Cat. Nr.	Pto9310	Pto9313	Pto9315	Pto9316	Pto9318	Pto9320	Pto9325	Pto9330
	Price	222,00	230,00	237,00	250,00	255,00	297,00	313,00	565,00	
	Storm collar-conical tightable	Cat. Nr.	Pto9410	Pto9413	Pto9415	Pto9416	Pto9418	Pto9420	Pto9425	Pto9430
	Price	18,00	19,00	20,00	21,00	24,00	29,00	30,00	30,00	

Rosette

	Wall rosette 70mm conical, tightable	Cat. Nr.	Ptu1010	Ptu1013	Ptu1015	Ptu1016	Ptu1018	Ptu1020	Ptu1025	Ptu1030
	Price	14,00	14,00	15,00	15,00	15,00	17,00	20,00	26,00	
	Wall rosette 110mm conical, tightable	Cat. Nr.	Ptu1110	Ptu1113	Ptu1115	Ptu1116	Ptu1118	Ptu1120	Ptu1125	Ptu1130
	Price	15,00	15,00	16,00	16,00	16,00	18,00	21,00	27,00	
	Plate rosette 2-sections 0-40°	Cat. Nr.	Ptu3010	Ptu3013	Ptu3015	Ptu3016	Ptu3018	Ptu3020	Ptu3025	Ptu3030
	Price	32,00	34,00	34,00	34,00	38,00	42,00	47,00	55,00	
	Plate rosette 2-sections, ventilated 0-40°	Cat. Nr.	Ptu3110	Ptu3113	Ptu3115	Ptu3116	Ptu3118	Ptu3120	Ptu3125	Ptu3130
	Price	32,00	34,00	34,00	34,00	38,00	42,00	47,00	55,00	
	Ceiling cover available colors: black / white / stainless steel	Cat. Nr.	Ptu4010	Ptu4013	Ptu4015	Ptu4016	Ptu4018	Ptu4020	Ptu4025	Ptu4030
	Price	45,00	51,00	57,00	57,00	66,00	75,00	90,00	105,00	

Associated accessories

	Brush PVC For cleaning stainless steel chimneys	Cat. Nr.	Ptx1011	Ptx1013	Ptx1014	Ptx1016	Ptx1018	Ptx1020		
	Price	29,00	30,00	31,00	34,00	40,00	44,00			

		material: Stainless steel	
		Description	Price
	Screw DIN571 stainless steel A2 8mm +washer M8	Cat. Nr.	Ptx2808
	Price	φ8x80mm	1,60
		φ8x130mm	2,40
		φ8x160mm	3,60
		φ8x200mm	6,60

		material: Stainless steel	
		Description	Price
	Cable for pvc brush	Cat. Nr.	Ptx1101
	Price	L=1,10m	17,00
		L=5,00m	29,00
		L=10,00m	47,00
		L=15,00m	53,00
		L=20,00m	66,00

		material: Stainless steel	
		Description	Price
	Lead tape 330x1000	Cat. Nr.	Ptx3033
	Price	330x1000 mm	150,-
	Silicon clear (transparent)	Cat. Nr.	Ptx3101
	Price	330x1000 mm	26,-

	Dowel Duopower 12x60 brick + plasterx + concrete	Cat. Nr.	Ptx2012
	Price	φ12x60mm	1,20

Inner wall diameter mm	100	130	150	160	180	200	250	300
Outer wall diameter mm	150	180	200	210	230	250	300	350
Inner wall thickness mm	0,50	0,50	0,50	0,50	0,50	0,50	0,50	0,50

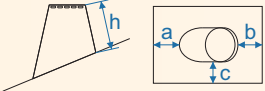
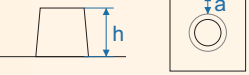
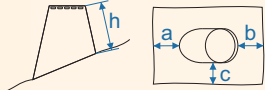
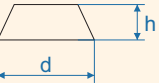

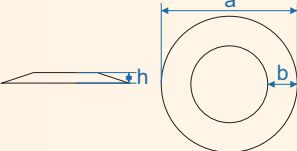
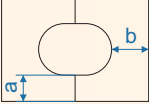
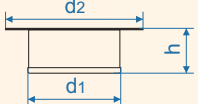







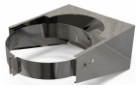
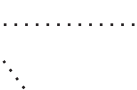

	Pto11xx	effective height	h	mm	250	250	250	250	250	250	250	250
		a	mm	150	150	150	150	150	150	150	150	150
	Pto12xx	a	mm	150	150	150	150	150	150	150	150	150
		b	mm	150	150	150	150	150	150	150	150	150
		c	mm	150	150	150	150	150	150	150	150	150
		weight	m	kg	2,20	2,60	2,90	3,10	3,40	3,70	4,40	5,40
	Pto50xx	effective height	h	mm	250	250	250	250	250	250	250	250
		a	mm	150	150	150	150	150	150	150	150	150
		weight	m	kg	2,00	2,40	2,70	2,90	3,10	3,40	4,00	5,00
	Pto92xx Pto93xx	effective height	h	mm	250	250	250	250	250	250	250	250
		a	mm	150	150	150	150	150	150	150	150	150
		b	mm	150	150	150	150	150	150	150	150	150
		c	mm	150	150	150	150	150	150	150	150	150
		weight Pto92xx	m	kg	5,20	5,40	5,50	5,60	5,70	5,80	6,50	7,50
		masa Pto93xx	m	kg	5,50	5,70	5,80	5,90	6,00	6,10	6,90	7,90
	Plk15xx	diameter	d	mm	193	223	243	253	273	293	343	393
		height	h	mm	100	100	100	100	100	100	100	100
		weight	m	kg	0,20	0,20	0,30	0,30	0,40	0,40	0,50	0,60

	Ptu10xx Ptu11xx	height (Ptu10)	h	mm	20	20	20	20	20	20	20	20
		coverage (Ptu10)	a	mm	240	270	290	300	320	340	390	440
		weight (Ptu10)	m	kg	70	70	70	70	70	70	70	70
		(Ptu11)	a	mm	320	350	370	380	400	420	470	520
		coverage (Ptu11)	a	mm	110	110	110	110	110	110	110	110
		weight (Ptu11)	m	kg	0,30	0,40	0,40	0,45	0,50	0,50	0,60	0,70
	Ptu30xx Ptu31xx	coverage	a	mm	80							
		coverage	b	mm	80							
		weight	m	kg	0,30	0,30	0,30	0,40	0,40	0,40	0,50	0,50
	Ptu40xx	diameter 1	d1	mm	200	230	250	260	280	300	-	-
		diameter 2	d2	mm	300	330	350	360	380	400	-	-
		height	h	mm	125	125	125	125	125	125	-	-
		weight	m	kg	1,00	1,10	1,20	1,30	1,40	1,50	-	-





Price in €

Inner wall diameter mm	100	130	150	160	180	200	250	300
Outer wall diameter mm	150	180	200	210	230	250	300	350
Inner wall thickness mm	0,50	0,50	0,50	0,50	0,50	0,50	0,50	0,50

Fixing elements

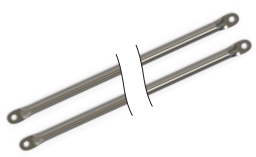
	Supporting wall bracket distance 2-15cm	Cat. Nr.	Ptn1010	Ptn1013	Ptn1015	Ptn1016	Ptn1018	Ptn1020	Ptn1025	Ptn1030
		Price	31,00	32,00	33,00	35,00	35,00	39,00	40,00	47,00
	Supporting wall bracket distance 15-25cm	Cat. Nr.	Ptn1110	Ptn1113	Ptn1115	Ptn1116	Ptn1118	Ptn1120	Ptn1125	Ptn11030
		Price	42,00	44,00	46,00	49,00	54,00	58,00	65,00	70,00
	Supporting wall bracket distance 25-35cm	Cat. Nr.	Ptn1210	Ptn1213	Ptn1215	Ptn1216	Ptn1218	Ptn1220	Ptn1225	Ptn1230
		Price	46,00	49,00	51,00	56,00	59,00	64,00	69,00	75,00
	Floor bracket Length of U-profile 2x40cm	Cat. Nr.	Ptn3010	Ptn3013	Ptn3015	Ptn3016	Ptn3018	Ptn3020	Ptn3025	Ptn3030
		Price	32,00	33,00	34,00	35,00	38,00	41,00	41,00	43,00
	Wall bracket unresponsive 5-10cm	Cat. Nr.	Ptn2010	Ptn2013	Ptn2015	Ptn2016	Ptn2018	Ptn2020	Ptn2025	Ptn2030
		Price	36,00	38,00	39,00	40,00	42,00	43,00	46,00	63,00
	Wall bracket unresponsive 10-20cm	Cat. Nr.	Ptn2110	Ptn2113	Ptn2115	Ptn2116	Ptn2118	Ptn2120	Ptn2125	Ptn2130
		Price	43,00	46,00	47,00	47,00	49,00	53,00	59,00	73,00
	Wall bracket unresponsive 20-35cm	Cat. Nr.	Ptn2210	Ptn2213	Ptn2215	Ptn2216	Ptn2218	Ptn2220	Ptn2225	Ptn2230
		Price	45,00	47,00	48,00	49,00	50,00	54,00	63,00	75,00
	Wall bracket unresponsive 35-50cm	Cat. Nr.	Ptn2310	Ptn2313	Ptn2315	Ptn2316	Ptn2318	Ptn2320	Ptn2325	Ptn2330
		Price	51,00	53,00	55,00	56,00	58,00	61,00	71,00	91,00
	Plate bracket 2x L-Profil 800mm	Cat. Nr.	Ptn3110	Ptn3113	Ptn3115	Ptn3116	Ptn3118	Ptn3120	Ptn3125	Ptn3130
		Price	43,00	46,00	48,00	50,00	52,00	54,00	61,00	71,00
	Plate bracket With joint 2x L-Profil 800mm	Cat. Nr.	Ptn3210	Ptn3213	Ptn3215	Ptn3216	Ptn3218	Ptn3220	Ptn3225	Ptn3230
		Price	47,00	51,00	55,00	55,00	57,00	59,00	65,00	74,00
	Bracket for static wires (for fixing with 3 wires or 2 rod)	Cat. Nr.	Ptn5010	Ptn5013	Ptn5015	Ptn5016	Ptn5018	Ptn5020	Ptn5025	Ptn5030
		Price	19,00	19,00	20,00	20,00	20,00	21,00	24,00	26,00
	Locking band statical (height 180mm)	Cat. Nr.	Ptn5510	Ptn5513	Ptn5515	Ptn5516	Ptn5518	Ptn5520	Ptn5525	Ptn5530
		Price	16,00	16,00	17,00	17,00	17,00	18,00	19,00	20,00
	Locking band (height 60mm)	Cat. Nr.	Ptn5610	Ptn5613	Ptn5615	Ptn5616	Ptn5618	Ptn5620	Ptn5625	Ptn5630
		Price	9,00	9,00	9,00	9,00	9,00	10,00	10,00	10,00

Fixing elements independent from chimney diameter

	Telescoping rod 2pcs stainless steel for static wires	<i>material: Stainless steel</i>		<i>material: Steel</i>			<i>material: Stainless steel</i>			
		Description	Price	Description	Price		Description	Price		
		Cat. Nr.	φ35x2,0m 2,50kg	Ptn5120 90,00	φ35x2,0m 2,50kg		Ptn5220 28,00	Cat. Nr.	L=330mm	Ptn4313 75,00
		Price	φ35x3,0m 3,80kg	Ptn5130 140,00	φ35x3,0m 3,80kg		Ptn5230 40,00	Price	L=400mm	Ptn4320 90,00
			φ42x4,0m 6,10kg	Ptn5140 220,00	φ42x4,0m 6,10kg		Ptn5240 60,00		L=500mm	Ptn4330 115,00
	φ42x6,0m 9,10kg	Ptn5160 320,00	φ42x6,0m 9,10kg	Ptn5260 80,00						
	Plate for telescoping rods for sheet metal cover (2pcs)	Cat. Nr.	pair (left + right) 1,0kg	Ptn5311 30,00	pair (left + right)	Ptn5312 20,00		Cat. Nr.	L=350mm	Ptn4035 49,00
		Price	pair (left + right) 1,2kg	Ptn5321 40,00	pair (left + right)	Ptn5322 20,00		Price	L=500mm	Ptn4050 69,00
			pair (left + right) 1,0kg	Ptn5331 30,00	pair (left + right)	Ptn5332 20,00			L=750mm	Ptn4075 79,00
									L=900mm	Ptn4090 109,00
							L=1200mm	Ptn4012 139,00		

Inner wall diameter mm	100	130	150	160	180	200	250	300
Outer wall diameter mm	150	180	200	210	230	250	300	350
Inner wall thickness mm	0,50	0,50	0,50	0,50	0,50	0,50	0,50	0,50

	Ptn10xx	total width total height weight	b h m	mm mm kg	175 97 0,80	205 99 0,90	223 101 1,00	233 101 1,00	253 103 1,00	275 104 1,10	325 110 1,15	375 113 2,07
	Ptn11xx	total width total height weight	b h m	mm mm kg	175 120 0,98	205 122 1,12	223 124 1,21	233 127 1,26	253 128 1,36	273 129 1,46	323 133 1,72	373 136 3,01
	Ptn12xx	total width total height weight	b h m	mm mm kg	175 143 1,40	205 145 1,56	223 147 1,67	233 148 1,73	253 149 1,84	273 150 1,96	323 151 2,26	373 152 3,87
	Ptn30xx	total width total height weight	b h m	mm mm kg	1010 50 1,04	1040 50 1,05	1060 50 1,06	1070 50 1,07	1090 50 1,08	1110 50 1,08	1160 50 1,11	1210 50 1,70
	Ptn20xx	total width total height weight	b h m	mm mm kg	175 54 0,60	203 54 0,70	223 54 0,80	233 54 0,80	253 54 0,80	273 54 0,90	323 54 1,10	373 54 1,20
	Ptn21xx	total width total height weight	b h m	mm mm kg	175 54 0,80	203 54 0,80	223 54 0,90	233 54 0,90	253 54 1,00	273 54 1,00	323 54 1,30	373 54 1,40
	Ptn22xx	total width total height weight	b h m	mm mm kg	175 54 0,90	203 54 1,00	223 54 1,10	233 54 1,10	253 54 1,10	273 54 1,20	323 54 1,40	373 54 1,60
	Ptn23xx	total width total height weight	b h m	mm mm kg	175 54 1,10	203 54 1,10	223 54 1,20	233 54 1,20	253 54 1,30	273 54 1,40	323 54 1,60	373 54 1,80
	Ptn31xx Ptn32xx	total width L-profile length weight	b c m	mm mm kg	230 800 1,80	260 800 1,80	280 800 1,90	290 800 1,90	310 800 1,90	330 800 1,90	380 800 2,00	430 800 2,30
	Ptn50xx	prong length ghoop width weight	a b m	mm mm kg	50 40 0,30	50 40 0,40	50 40 0,40	50 40 0,40	50 40 0,50	50 40 0,50	50 40 0,60	50 40 0,70

	Ptn43xx	total length total height weight	a h m	mm mm kg	155 370 2,10	125 370 2,10	100 370 2,10	90 370 2,10	75 370 2,10	55 370 2,10	- 370 2,10	- 370 2,10
	Ptn43xx	total length total height weight	a h m	mm mm kg	225 440 2,80	195 440 2,80	170 440 2,80	160 440 2,80	145 440 2,80	125 440 2,80	75 440 2,80	25 440 2,80
	Ptn43xx	total length total height weight	a h m	mm mm kg	325 540 4,10	295 540 4,10	270 540 4,10	260 540 4,10	245 540 4,10	225 540 4,10	175 540 4,10	125 540 4,10
	Ptn4035	max.distance total height weight	a h m	mm mm kg	175 215 1,10	145 215 1,10	120 215 1,10	110 215 1,10	95 215 1,10	75 215 1,10	25 215 1,10	- 215 1,10
	Ptn4050	max.distance total height weight	a h m	mm mm kg	325 346 1,80	295 346 1,80	270 346 1,80	260 346 1,80	245 346 1,80	225 346 1,80	175 346 1,80	125 346 1,80
	Ptn4075	max.distance total height weight	a h m	mm mm kg	575 422 2,50	545 422 2,50	520 422 2,50	510 422 2,50	495 422 2,50	475 422 2,50	425 422 2,50	375 422 2,50
	Ptn4090	max.distance total height weight	a h m	mm mm kg	725 503 3,20	695 503 3,20	670 503 3,20	660 503 3,20	645 503 3,20	625 503 3,20	575 503 3,20	525 503 3,20
	Ptn4012	max.distance total height weight	a h m	mm mm kg	1025 596 4,30	995 596 4,30	970 596 4,30	960 596 4,30	945 596 4,30	925 596 4,30	875 596 4,30	825 596 4,30



www.inoxterm.com

INOXTERM GmbH
Österreich
Rainergasse 1/2
8750 Judenburg

+43 66 779 72 513
info@inoxterm.com