

RUBANS FRONCEURS

ET ACCESSOIRES DE CONFECTION



**RENÉ
HERAUD**
Rubans et Accessoires
pour l'ameublement

Tisseur depuis 1966

N°1 FRANÇAIS DU RUBAN POUR L'AMEUBLEMENT



Née en 1966, dans la région stéphanoise, la société RUBANS RENE HERAUD développe son savoir-faire dans la fabrication de rubans fronceurs destinés à la confection de rideaux et revendique sa position de leader français de rubans pour l'ameublement.

Aujourd'hui, la gamme de rubans fronceurs, c'est plus de 100 références déclinées dans différentes largeurs et coloris, distribuées dans les principaux pays européens.

La société HERAUD RUBANS innove, chaque année, en proposant de nouvelles solutions pour suspendre les rideaux.

Afin de conforter son positionnement sur les marchés de la décoration d'intérieur, sa gamme de rubans s'est enrichie d'une large collection d'accessoires pour la décoration de la fenêtre : passementerie, tringlerie, mécanisme sur mesure pour stores et parois japonaises.

Découvrez l'ensemble de notre savoir-faire sur notre site www.rubans-heraud.com

Founded in 1966 in Auvergne Rhône Alpes area, RUBANS RENE HERAUD develops its expertise in the manufacturing of curtain heading tapes and is today the French leading cie in tapes intended for home furnishing.

We currently offer a range of curtain heading tapes including more than 100 references available in different widths and colors, distributed in the main European countries.

RUBANS RENE HERAUD innovates each year by proposing new solutions for hanging curtains.

In order to strengthen our leading position on the home furnishing markets, we in addition propose a wide collection of accessories for window decoration: trimmings, rods, made to measure systems for blinds and panels.

Discover more about us on www.rubans-heraud.com



BOITES DÉROULEUSES RECHARGEABLES : UN CHOIX DURABLE POUR L'ENVIRONNEMENT

Depuis 2024, la société HERAUD RUBANS a fait le choix d'éliminer progressivement, les boîtes en carton jetables, afin de les remplacer par des **boîtes en Polypropylène 100% recyclable**.

L'utilisation de boîtes en plastique rechargeables présente de nombreux avantages, tant pour l'environnement que pour les consommateurs.

- **Réduction des déchets :** en optant pour des contenants réutilisables, nous diminuons considérablement la production de déchets plastiques qui finissent souvent dans les décharges ou les océans.
- **Conservation des ressources :** la fabrication de nouveaux contenants cartons nécessite une grande quantité d'énergie et de matières premières. En réutilisant les mêmes contenants, on économise ces ressources précieuses.
- **Diminution de la pollution :** le cycle de vie d'une boîte plastique peut durer jusqu'à 5 ans et contribue à réduire l'impact environnemental.

En choisissant des boîtes rechargeables, nous nous engageons dans une **démarche écoresponsable** afin de contribuer à un avenir plus durable.

Référence petite boîte grise :

ZBOIT 008 - C252

25 → 60 mm



Référence grande boîte grise :

ZBOIT 009 - C252

70 → 100 mm



RUBANS

PLI & FRONCE

FALTENBAND





FETTUCCIA AUTO ARRICCIANTE

PLEATS TAPE



PRÉSENTATION

AUFMACHUNG / CONFEZIONE / PACKAGING

 x 50m	Boîte dévidoir x 50 mètres	AB
 x 100m	Boîte dévidoir x 100 mètres	AC
 x 100m	Bobine filmée x 100 mètres	BC
 x 200m	Bobine filmée x 200 mètres	ED
 x 50m	Bobine filmée x 50 mètres	BB



RÉFÉRENCES COULEURS



Ecu



Blanc



Sable



Apprêt



7100

Noir



3

Cylindré

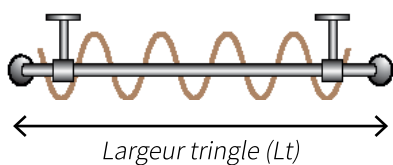

Pour fronce libre :

$$Lr = Lt \times 1.5 \text{ à } 3$$

Pour pli automatique
d'amplitude 2 :

$$Lr = Lt \times 2$$

■ POUR RAPPEL

Les **fronces libres** ont une amplitude variable de 1.5 à 3. Les fronces sont réparties librement sur le rideau et permettent d'ajuster la laize à la largeur de la fenêtre.

Les **plis** ont une amplitude fixe, ce qui assure une régularité dans la mise en place de la tête de rideau.

Pour obtenir un pli esthétique au niveau de la tête de rideaux, nous conseillons d'ajouter 50% à la largeur de la tringle (Lt) pour obtenir votre largeur de rideaux (Lr).

RUBANS

FRONCEURS

AMPLITUDE LIBRE

FREIE ZUGABE/ AMPIEZZA LIBERA / FREE ADDITION

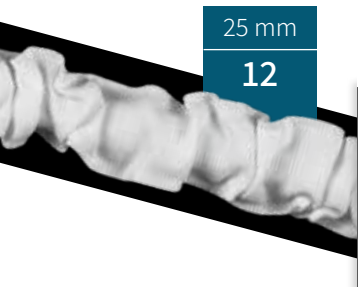

25 mm

12

	X 50m	X 100m	X 100m	X 50m		AMPLITUDE ZUGABE AMPIEZZA ADDITION	CORDON ZUGSCHNUERE CORDE PULL CORD	COMPOSITION ZUSAMMENSETZUNG COMPOSIZIONE COMPOSITION
-	12/AC 0	12/BC 0	-	-		1.5→3	-	100% polyester
12/AB 2	12/AC 2	12/BC 2	12/BB 2					
12/AB 5	12/AC 5	12/BC 5	12/BB 5					

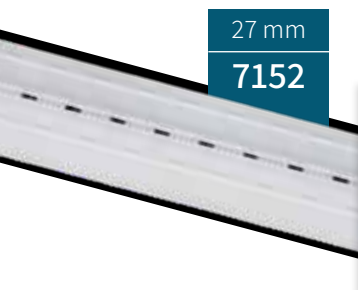
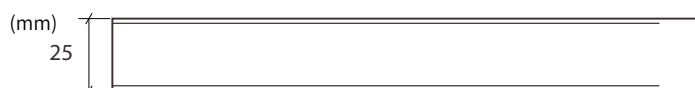

27 mm

7152

7152/AB M3	7152/AC M3	7152/BC M3	7152/BB M3		1.5→3	2	100% polyester
------------	------------	------------	------------	--	-------	---	----------------



RUBAN SPÉCIAL
DOUBLURE

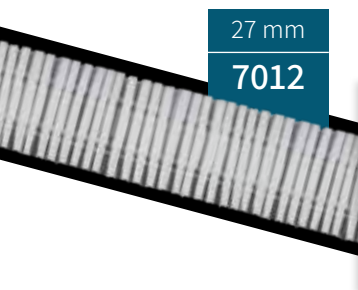

27 mm

7012

-	7012/AC 0	7012/BC 0	-	-		1.5→3	2	100% polyester
7012/AB 2	7012/AC 2	7012/BC 2	7012/BB 2					
7012/AB 5	7012/AC 5	7012/BC 5	7012/BB 5					

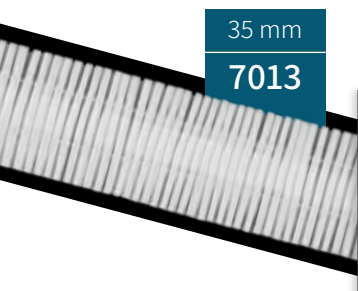
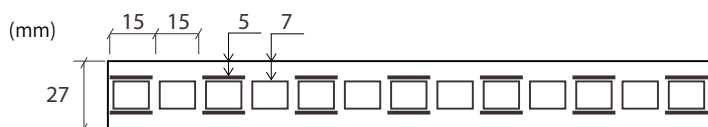

35 mm

7013

-	7013/AC 0	7013/BC 0	-	-		1.5→3	2	100% polyester
7013/AB 2	7013/AC 2	7013/BC 2	7013/BB 2					
7013/AB 5	7013/AC 5	7013/BC 5	7013/BB 5					



RUBANS

FRONCEURS

AMPLITUDE LIBRE

FREIE ZUGABE / AMPIEZZA LIBERA / FREE ADDITION

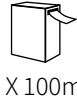

AMPLITUDE
ZUGABE
AMPIEZZA
ADDITION

CORDON
ZUGSCHNUERE
CORDE
PULL CORD

COMPOSITION
ZUSAMMENSETZUNG
COMPOSIZIONE
COMPOSITION

-	-	7041/BC 0	-	○	1.5→3	2	100% polyester
7041/AB 2	-	7041/BC 2	7041/BB 2	○			

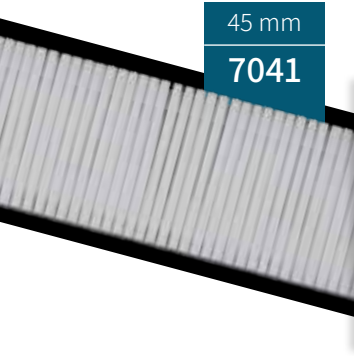

45 mm

7041

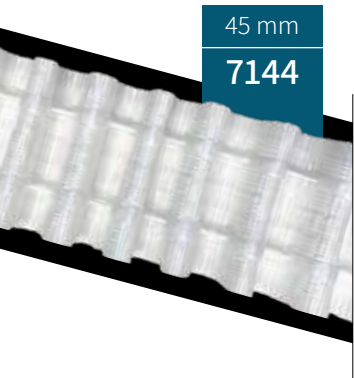
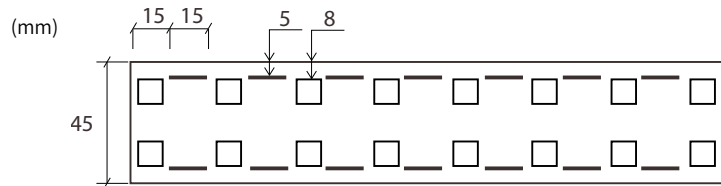

45 mm

7144

7144/AB 0	-	7144/BC 0	7144/BB 0	○	1.5→3	2	60% polyester 40% polypropylène
-----------	---	-----------	-----------	---	-------	---	------------------------------------

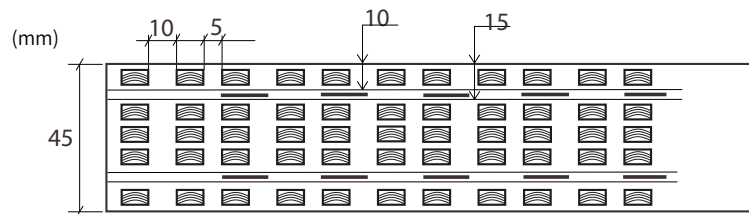

Poches à fils

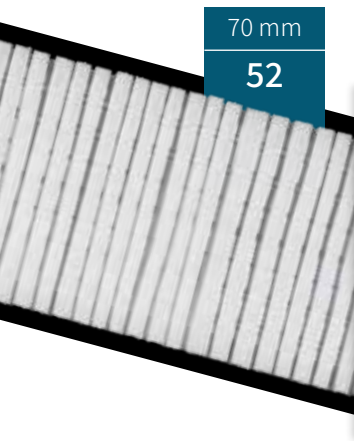

70 mm

52

-	52/AC 0	52/BC 0	52/BB 0	○	1.5→3	4	60% polyester 40% polypropylène
---	---------	---------	---------	---	-------	---	------------------------------------

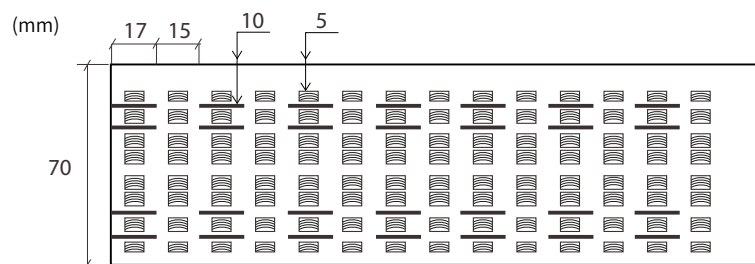

Poches à fils

RUBANS

FRONCEURS

AMPLITUDE LIBRE

FREIE ZUGABE/ AMPIEZZA LIBERA / FREE ADDITION



X 50m



X 100m



X 100m



X 50m



AMPLITUDE

ZUGABE
AMPIEZZA
ADDITION

CORDON

ZUGSCHNUERE
CORDE
PULL CORD

COMPOSITION

ZUSAMMENSETZUNG
COMPOSIZIONE
COMPOSITION

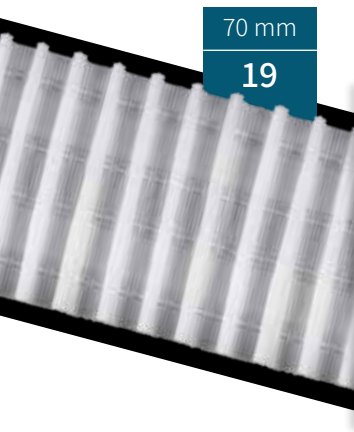

19/AB 2	-	19/BC 2	19/BB 2		1.5→3	4	60% polyester 40% polypropylène
19/AB 5	-	19/BC 5	19/BB 5				

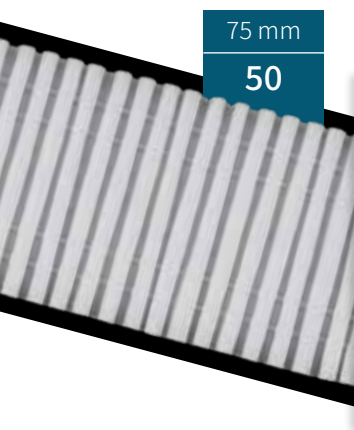
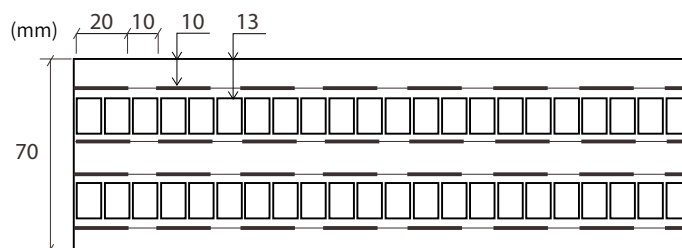

50/AB 0	50/AC 0	50/BC 0	50/BB 0		1.5→3	4	60% polyester 40% polypropylène
50/AB 5	50/AC 5	50/BC 5	50/BB 5				

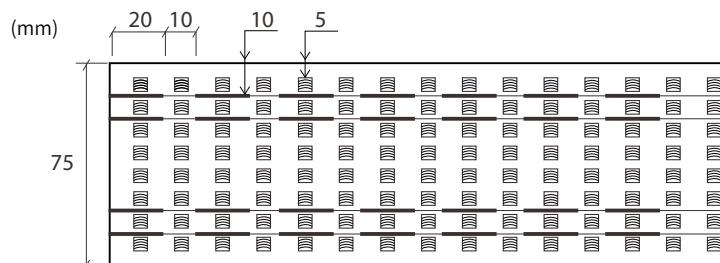

Poches à fils

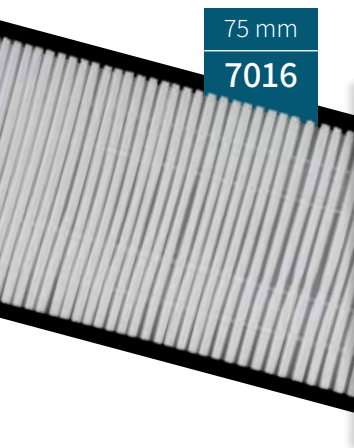

7016/AB 2	-	7016/BC 2	7016/BB 2		1.5→3	4	100% polyester
7016/AB 5	-	7016/BC 5	7016/BB 5				

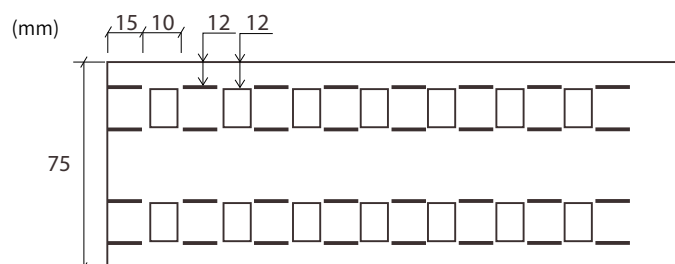





RUBANS

PLISSEURS

PLI AUTOMATIQUE

FALTENBAND / FETTUCCIA AUTOARRICCIANTE / PLEATS TAPE

 X 50m	 X 100m	 X 100m	 X 50m		AMPLITUDE ZUGABE AMPIEZZA ADDITION	CORDON ZUGSCHNUERE CORDE PULL CORD	COMPOSITION ZUSAMMENSETZUNG COMPOSIZIONE COMPOSITION
---	--	--	---	---	--	--	--

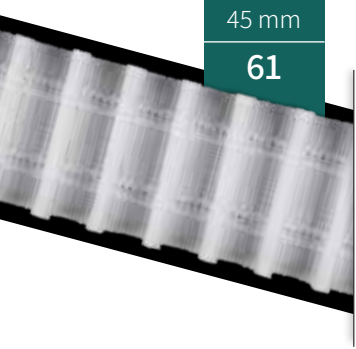

-	61/AC 2	61/BC 2	-		2 ou 2.5	4	60% polyester 40% polypropilène
-	61/AC 5	61/BC 5	-				

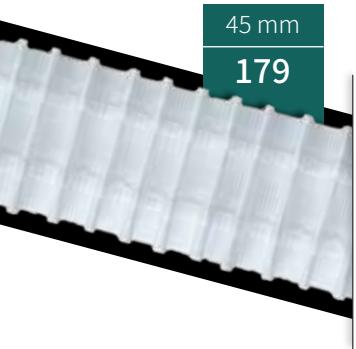
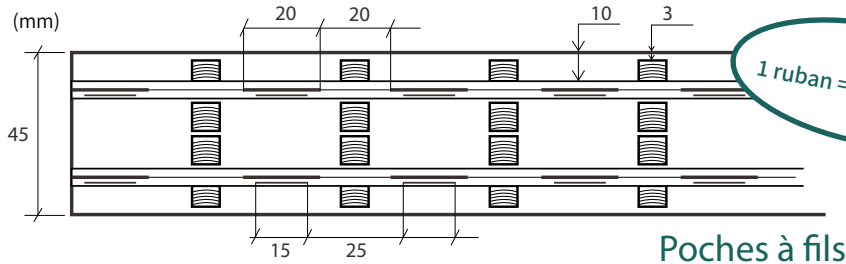

-	179/AC 0	179/BC 0	-		2	2	60% polyester 40% polypropilène
-	179/AC 2	179/BC 2	-				

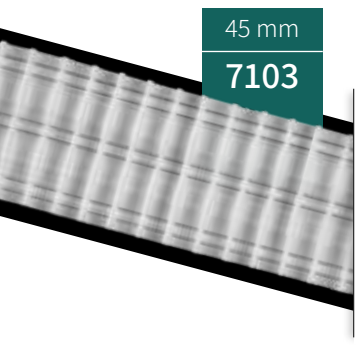
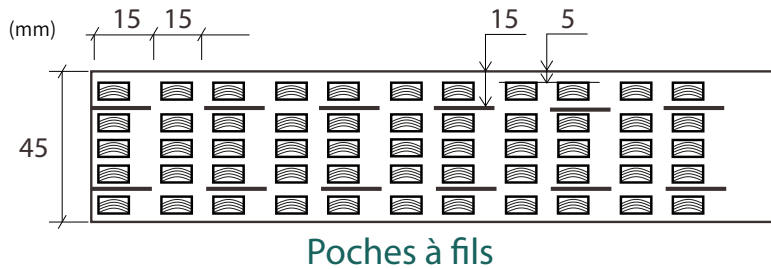

7103/AB 2	7103/AC 2	7103/BC 2	7103/BB 2		2	2	100% polyester
-----------	-----------	-----------	-----------	---	---	---	----------------

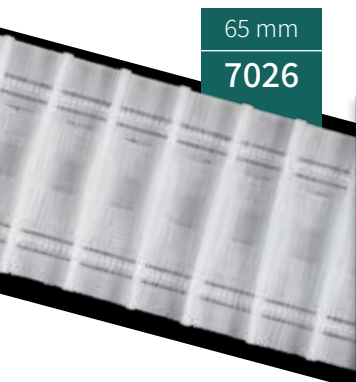
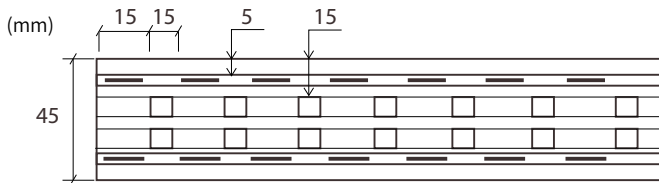

-	-	7026/BC 2	7026/BB 2		2	3	100% polyester
-	-	7026/BC 5	7026/BB 5				

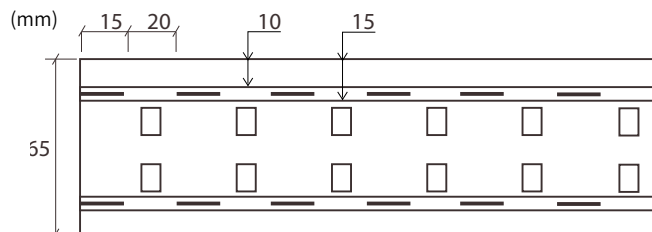

RUBANS

PLISSEURS

PLI AUTOMATIQUE

FALTENBAND / FETTUCCIA AUTOARRICCIANTE / PLEATS TAPE



X 50m



X 100m



X 100m



X 50m



AMPLITUDE
ZUGABE
AMPIEZZA
ADDITION

CORDON
ZUGSCHNUERE
CORDE
PULL CORD

COMPOSITION
ZUSAMMENSETZUNG
COMPOSIZIONE
COMPOSITION

-	7104/AC 2	7104/BC 2	7104/BB 2		2	3	100% polyester
---	-----------	-----------	-----------	--	---	---	----------------

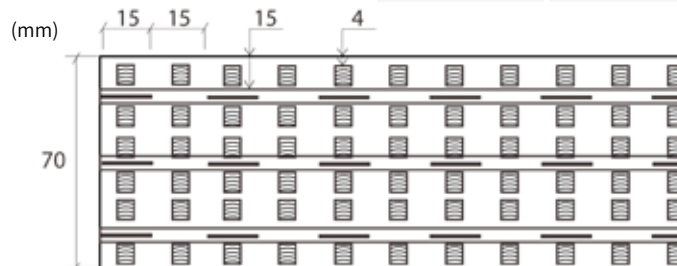

Poches à fils

70 mm

7104

70 mm

16

16/AB 2	16/AC 2	16/BC 2	16/BB 2		2	4	100% polyester
16/AB 5	16/AC 5	16/BC 5	16/BB 5				
16/AB 7100	-	16/BC 7100	16/BB 7100				

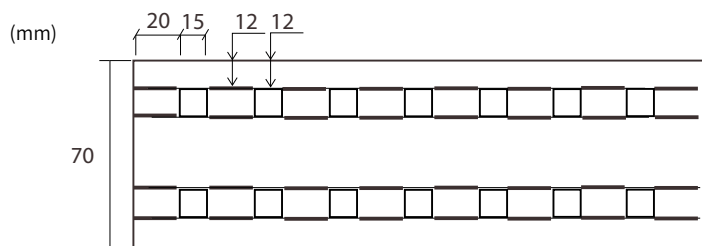

75 mm

7019

7019/AB 2	-	7019/BC 2	7019/BB 2		2	3	100% polyester
7019/AB 5	-	7019/BC 5	7019/BB 5				
7019/AB 7100	-	7019/BC 7100	7019/BB 7100				

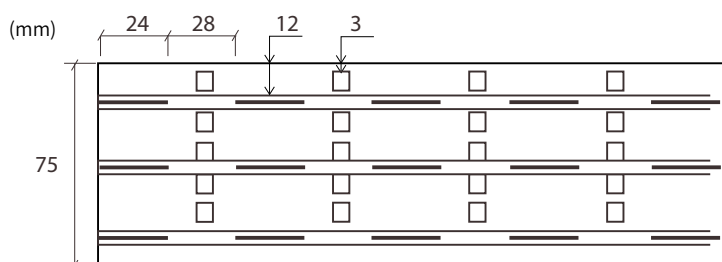

RUBANS

PLISSEURS

PLI AUTOMATIQUE

FALTENBAND / FETTUCCIA AUTOARRICCIANTE / PLEATS TAPE

 X 50m	 X 100m	 X 100m	 X 50m		AMPLITUDE ZUGABE AMPIEZZA ADDITION	CORDON ZUGSCHNUERE CORDE PULL CORD	COMPOSITION ZUSAMMENSETZUNG COMPOSIZIONE COMPOSITION
--	---	---	--	---	--	--	--

75 mm

7020

7020/AB 2	-	7020/BC 2	7020/BB 2		2	2	100% polyester
7020/AB 5	-	7020/BC 5	7020/BB 5				

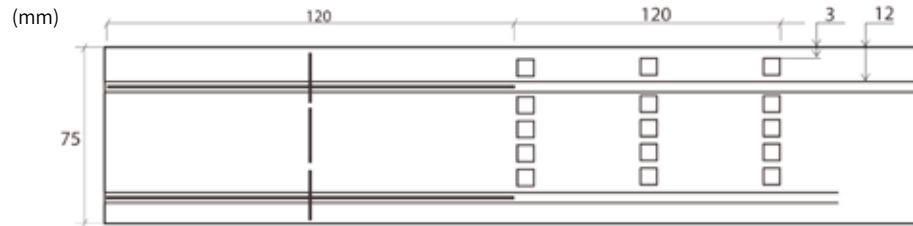

75 mm

7022

7022/AB 2	-	7022/BC 2	7022/BB 2		2.5	2	100% polyester
-----------	---	-----------	-----------	---	-----	---	----------------

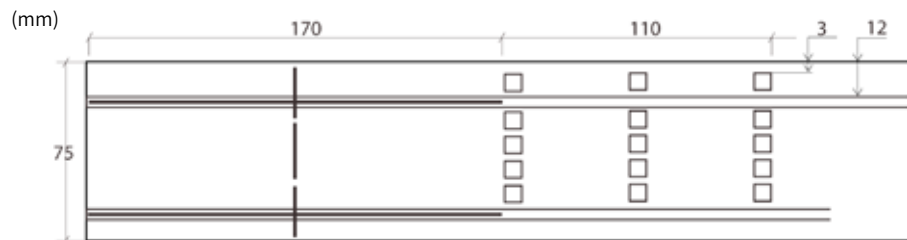

75 mm

7023

7023/AB 2	-	7023/BC 2	7023/BB 2		2.8	2	100% polyester
-----------	---	-----------	-----------	---	-----	---	----------------



RUBANS

PLISSEURS

PLI AUTOMATIQUE

FALTENBAND / FETTUCCIA AUTOARRICCIANTE / PLEATS TAPE

 X 50m	 X 100m	 X 100m	 X 50m		AMPLITUDE ZUGABE AMPIEZZA ADDITION	CORDON ZUGSCHNUERE CORDE PULL CORD	COMPOSITION ZUSAMMENSETZUNG COMPOSIZIONE COMPOSITION
--	---	---	--	---	--	--	--



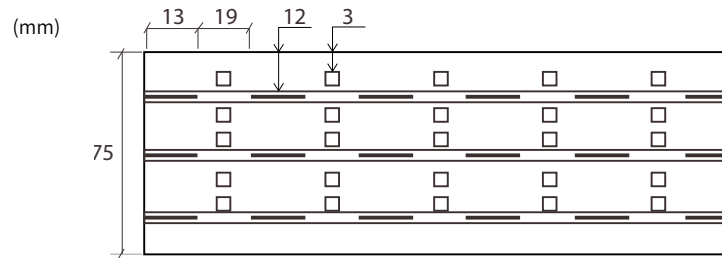

75 mm
7017

7017/AB 2	-	7017/BC 2	-		2	3	100% polyester
7017/AB 5	-	7017/BC 5	-				



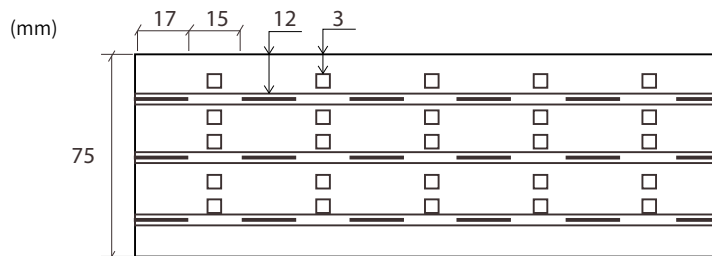

75 mm
7018

7018/AB 2	-	7018/BC 2	7018/BB 2		2.5	3	100% polyester
7018/AB 5	-	7018/BC 5	7018/BB 5				



75 mm
7033

7033/AB 2	-	7033/BC 2	7033/BB 2		2	3	100% polyester
7033/AB 5	-	7033/BC 5	7033/BB 5				

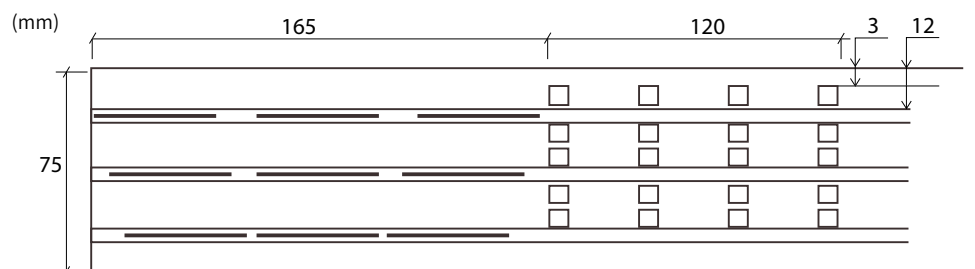

RUBANS

PLISSEURS

PLI AUTOMATIQUE

FALTENBAND / FETTUCCIA AUTOARRICCIANTE / PLEATS TAPE

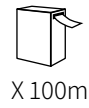

AMPLITUDE
ZUGABE
AMPIEZZA
ADDITION

CORDON
ZUGSCHNUERE
CORDE
PULL CORD

COMPOSITION
ZUSAMMENSETZUNG
COMPOSIZIONE
COMPOSITION



75 mm

7127

-	-	7127/BC 2	7127/BB 2	○	1.5	3	100% polyester
---	---	-----------	-----------	---	-----	---	----------------

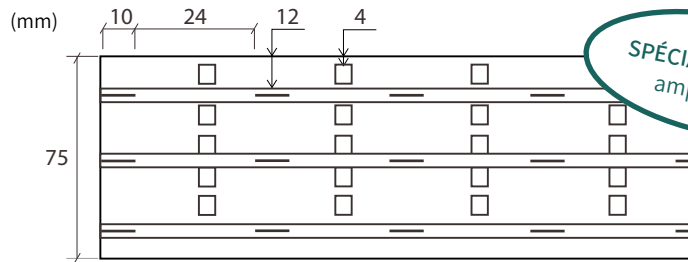

75 mm

60

-	60/AC 2	60/BC 2	60/BB 2	○	2 ou 2.5	4	60% polyester 40% polypropylène
---	---------	---------	---------	---	----------	---	------------------------------------

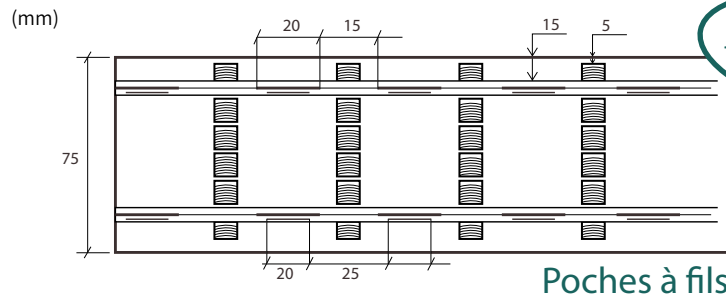

75 mm

7113

-	7113/AC 2	7113/BC 2	-	○	2.5	3	100% polyester
---	-----------	-----------	---	---	-----	---	----------------

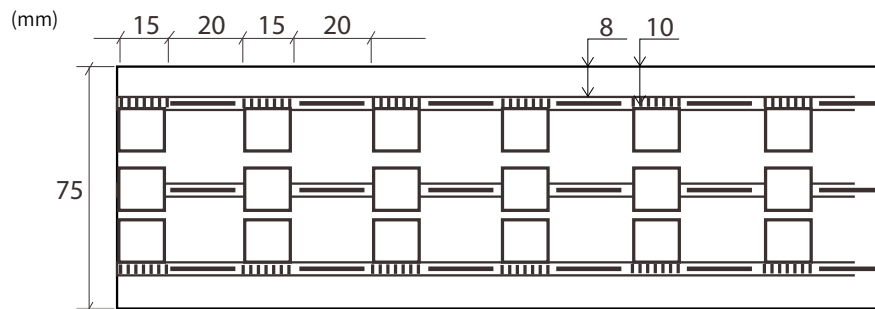

RUBANS

PLISSEURS

PLI AUTOMATIQUE

FALTENBAND / FETTUCCIA AUTOARRICCIANTE / PLEATS TAPE



X 50m



X 100m



X 100m



X 50m



AMPLITUDE

ZUGABE
AMPIEZZA
ADDITION

CORDON

ZUGSCHNUERE
CORDE
PULL CORD

COMPOSITION

ZUSAMMENSETZUNG
COMPOSIZIONE
COMPOSITION



75 mm

7078

7078/AB 2	-	-	7078/BB 2		2	2	100% polyester
-----------	---	---	-----------	--	---	---	----------------

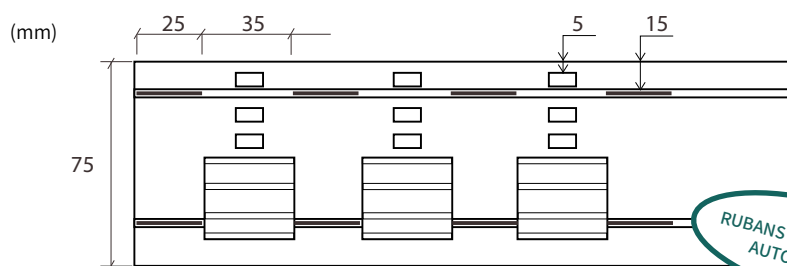

RUBANS POUR DOUBLURE
AUTO-AGGRIPANT

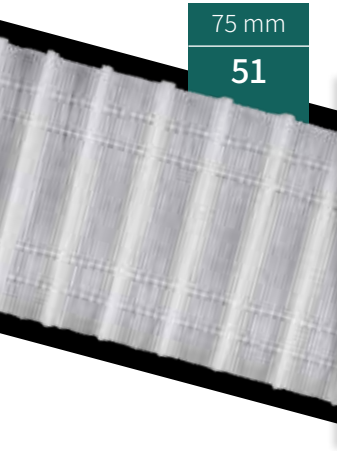

75 mm

51

51/AB 0	-	51/BC 0	51/BB 0		2	4	60% polyester 40% polypropylène
51/AB 5	-	51/BC 5	51/BB 5				

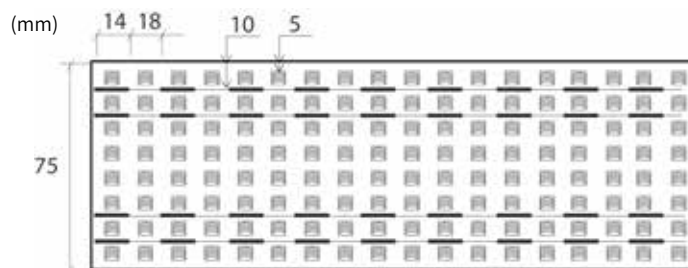

Poches à fils

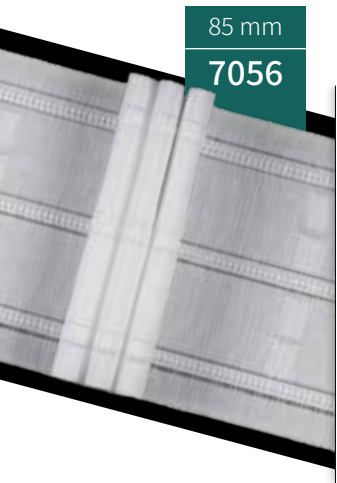

85 mm

7056

7056/AB 2	-	7056/BC 2	7056/BB 2		2	3	100% polyester
-----------	---	-----------	-----------	--	---	---	----------------

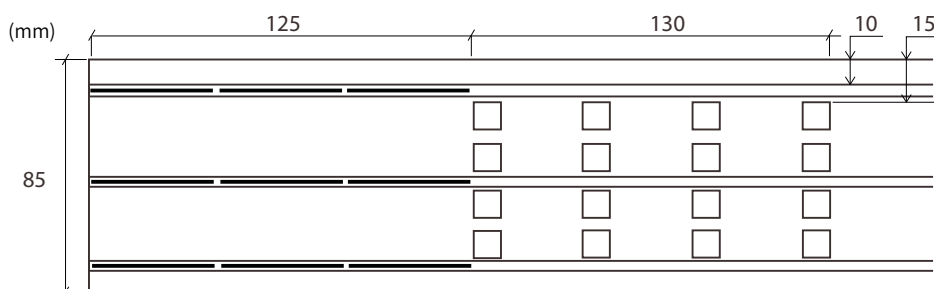

RUBANS

PLISSEURS

PLI AUTOMATIQUE

FALTENBAND / FETTUCCIA AUTOARRICCIANTE / PLEATS TAPE



X 50m



X 100m



X 100m



X 50m



AMPLITUDE

ZUGABE
AMPIEZZA
ADDITION

CORDON

ZUGSCHNUERE
CORDE
PULL CORD

COMPOSITION

ZUSAMMENSETZUNG
COMPOSIZIONE
COMPOSITION

85 mm

7039

7039/AB 2

- 7039/BC 2

7039/BB 2



2

3

100% polyester

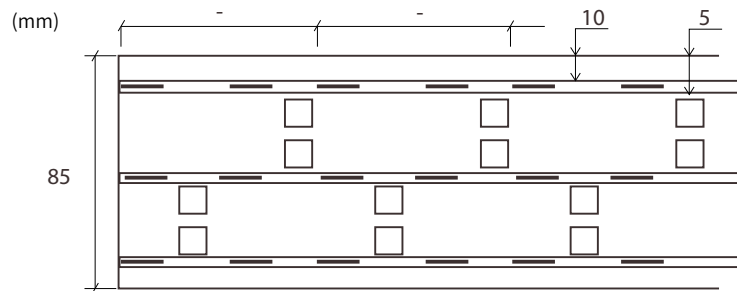

90 mm

7105

- 7105/AC 2

7105/BC 2



2

3

100% polyester

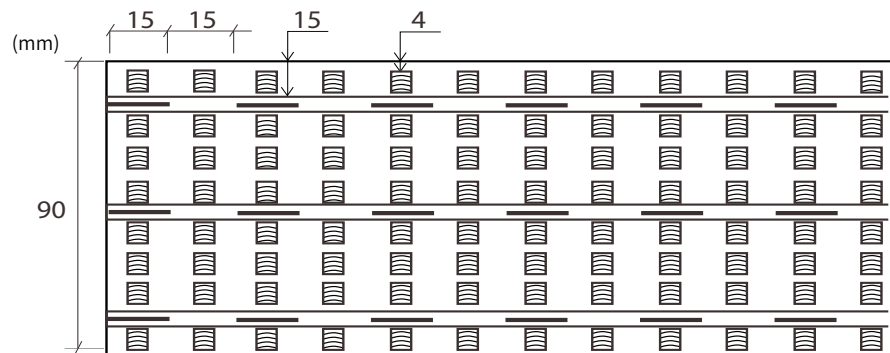

Poches à fils

100 mm

7070

7070/AB 2

-

7070/BC 2

7070/BB 2



2

3

100% polyester



RUBANS

PLISSEURS

PLI AUTOMATIQUE

FALTENBAND / FETTUCCIA AUTOARRICCIANTE / PLEATS TAPE

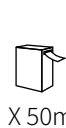

X 50m



X 100m

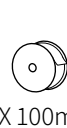

X 100m

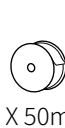

X 50m



AMPLITUDE

ZUGABE
AMPIEZZA
ADDITION

CORDON

ZUGSCHNUERE
CORDE
PULL CORD

COMPOSITION

ZUSAMMENSETZUNG
COMPOSIZIONE
COMPOSITION

120 mm

7071

7071/AB 2	-	7071/BC 2	7071/BB 2		2	4	100% polyester
7071/AB 5	-	7071/BC 5	7071/BB 5				

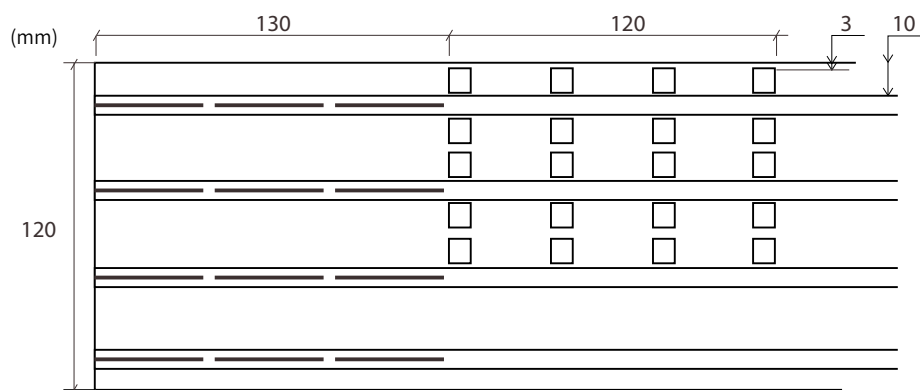

120 mm

7072

7072/AB 2	-	7072/BC 2	7072/BB 2		2	4	100% polyester
-	-	7072/BC 5	-				

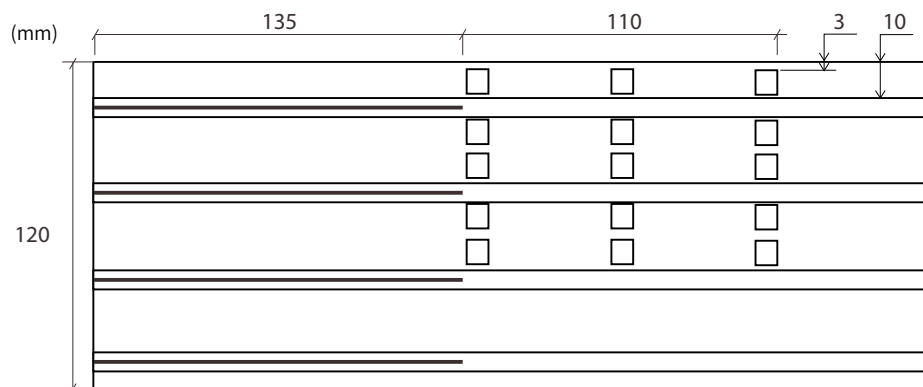

RUBANS

PLISSEURS

PLI AUTOMATIQUE

FALTENBAND / FETTUCCIA AUTOARRICCIANTE / PLEATS TAPE

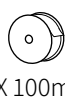

AMPLITUDE
ZUGABE
AMPIEZZA
ADDITION

CORDON
ZUGSCHNUERE
CORDE
PULL CORD

COMPOSITION
ZUSAMMENSETZUNG
COMPOSIZIONE
COMPOSITION

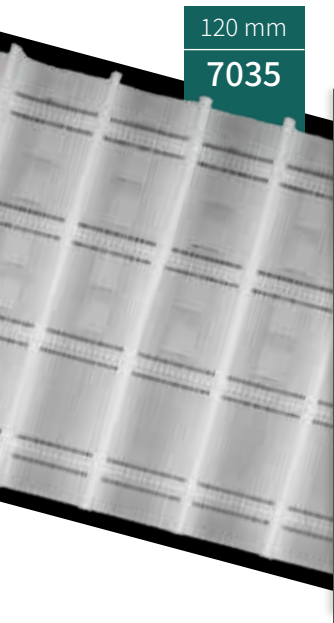

7035/AB 2	-	7035/BC 2	7035/BB 2		2	4	100% polyester
7035/AB 5	-	7035/BC 5	7035/BB 5				

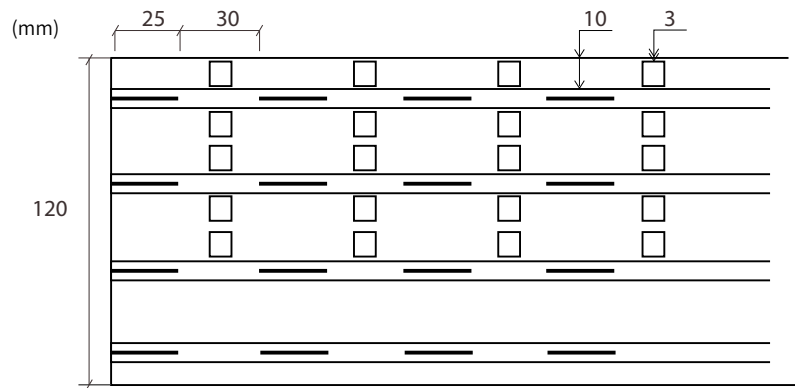

55/AB 0	-	-	55/BB 0		2	4	60% polyester 40% polypropylène
---------	---	---	---------	--	---	---	------------------------------------

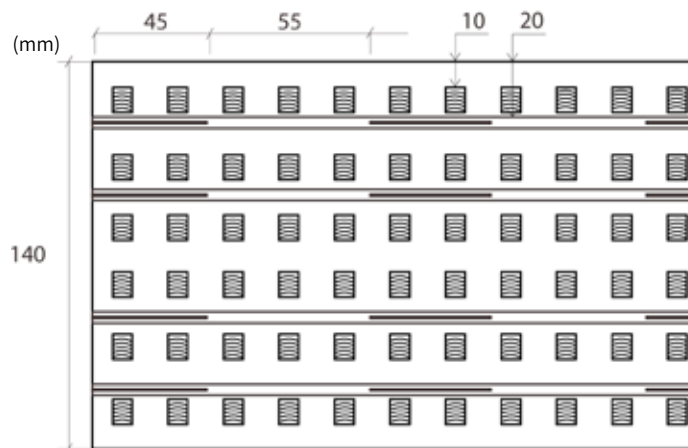

Poches à fils

RUBANS TRANSPARENT

TRANSPARENTES BLEISTIFTFALTENBAND
FETTUCCIA AUTOARRICCIANTE TRASPARENTE
TRANSPARENT PENCIL PLEATS TAPE



PRÉSENTATION

AUFMACHUNG / CONFEZIONE / PACKAGING

 x 50m	Boîte dévidoir x 50 mètres	AB
 x 100m	Boîte dévidoir x 100 mètres	AC
 x 50m	Bobine filmée x 50 mètres	BB
 x 100m	Bobine filmée x 100 mètres	BC
 x 200m	Bobine filmée x 200 mètres	ED



RÉFÉRENCES COULEURS



Apprêté

- Spécialement conçu pour les voilages ou des tissus légers, les rubans transparents garantissent une belle tenue du rideau tout en préservant l'aspect invisible de la confection. Nos cordons de tirage sont 100 % transparent et se fondent dans la tête du rideau.

RUBANS

PLI TRANSPARENT

PLI AUTOMATIQUE TRANSPARENTES FALTENBAND
FETTUCCIA AUTOARRICCIANTE TRASPARENTE / TRANSPARENT PLEATS TAPE



X 50m



X 100m



x 50m



X 100m



X 200m

AMPLITUDE

ZUGABE
AMPIEZZA
ADDITION

CORDON

ZUGSCHNUERE
CORDE
PULL CORD

COMPOSITION

ZUSAMMENSETZUNG
COMPOSIZIONE
COMPOSITION

35 mm

15

15/AB 9

15/AC 9

15/BB 9

-

-

2

2

100% polyester

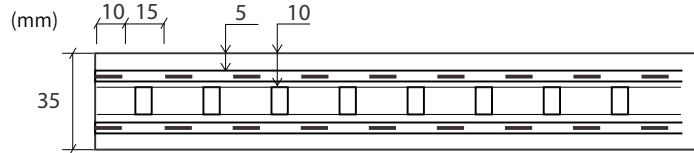

45 mm

171

171/AB 9

171/AC 9

171/BB 9

171/BC 9

-

2

3

100% polyester

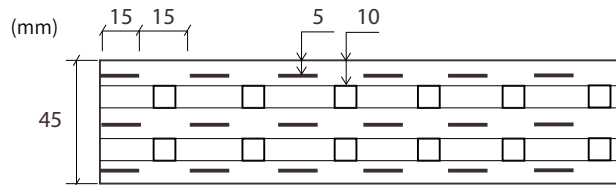

75 mm

7083

7083/AB 9

7083/AC 9

7083/BB 9

7083/BC 9

-

2

3

100% polyester

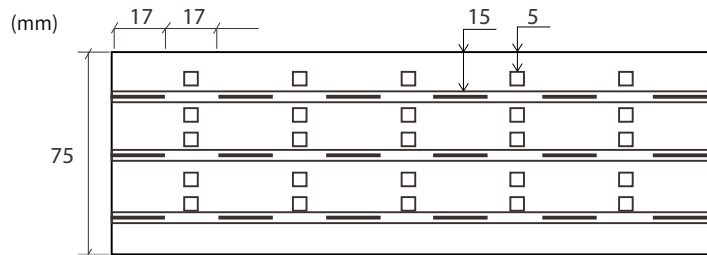

75 mm

7030

7030/AB 9

7030/AC 9

7030/BB 9

7030/BC 9

-

2.5

3

100% polyester

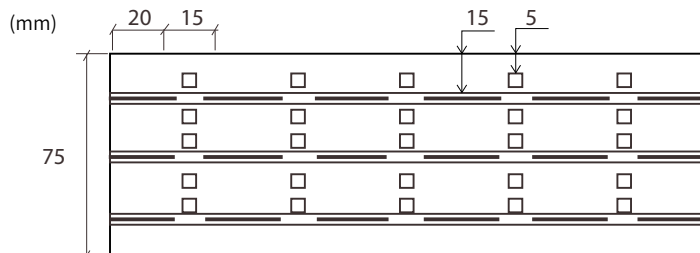

RUBANS

PLI TRANSPARENT

PLI AUTOMATIQUE TRANSPARENTES FALTENBAND
 FETTUCCIA AUTOARRICCIANTE TRASPARENTE / TRANSPARENT PLEATS TAPE



X 50m



X 100m



x 50m



X 100m



X 200m

AMPLITUDE
 ZUGABE
 AMPIEZZA
 ADDITION

CORDON
 ZUGSCHNUERE
 CORDE
 PULL CORD

COMPOSITION
 ZUSAMMENSETZUNG
 COMPOSIZIONE
 COMPOSITION

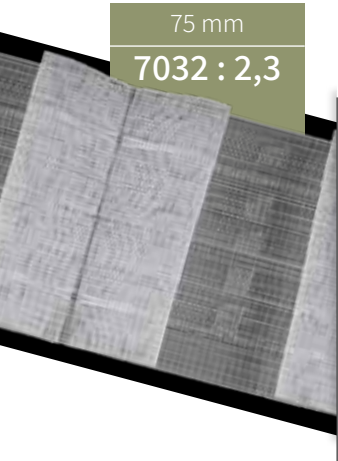

75 mm

7032 : 2,3

7032/AB 9	-	7032/BB 9	7032/BC 9	-	2.3	3	100% polyester
-----------	---	-----------	-----------	---	-----	---	----------------

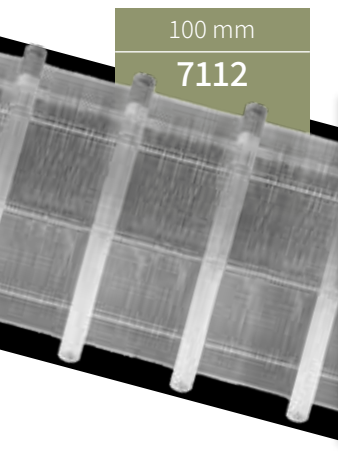
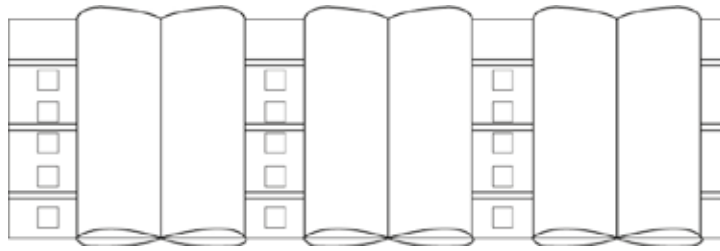

100 mm

7112

7112/AB 9	-	-	7112/BC 9	-	2	3	100% polyester
-----------	---	---	-----------	---	---	---	----------------

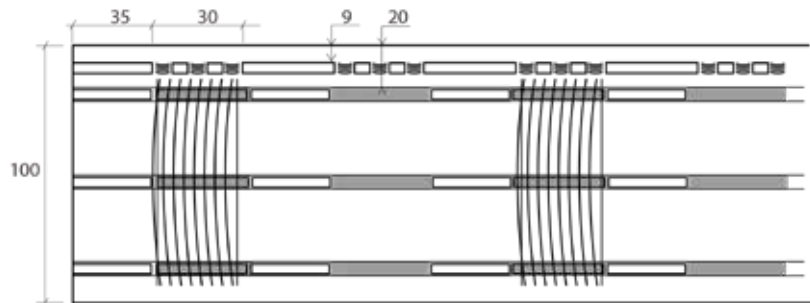

120 mm

7036



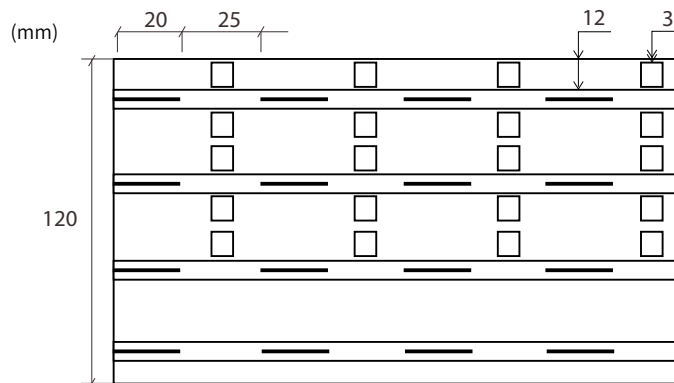

7036/AB 9	-	7036/BB 9	7036/BC 9	-	2	4	100% polyester
-----------	---	-----------	-----------	---	---	---	----------------



RUBANS

PLI TRANSPARENT

PLI AUTOMATIQUE TRANSPARENTES FALTENBAND
 FETTUCCIA AUTOARRICCIANTE TRASPARENTE / TRANSPARENT PLEATS TAPE

 X 50m	 X 100m	 x 50m	 X 100m	 X 200m	AMPLITUDE ZUGABE AMPIEZZA ADDITION	CORDON ZUGSCHNUERE CORDE PULL CORD	COMPOSITION ZUSAMMENSETZUNG COMPOSIZIONE COMPOSITION
--	---	--	---	---	--	--	--



120 mm

7038

7038/AB 9	-	7038/BB 9	7038/BC 9	-	2.5	4	100% polyester
-----------	---	-----------	-----------	---	-----	---	----------------

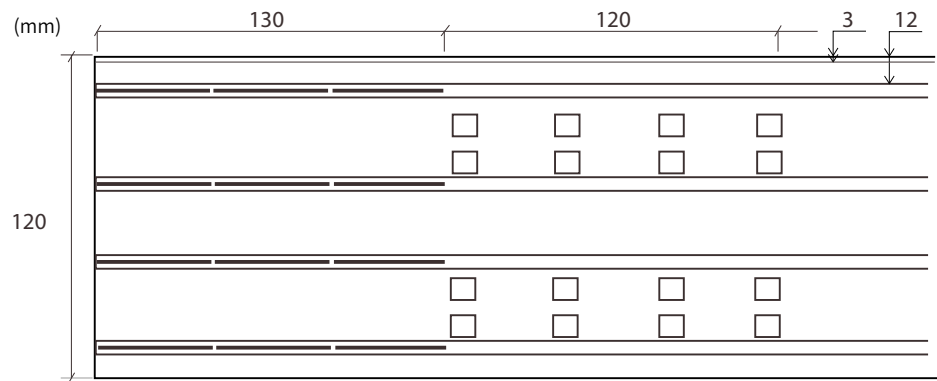

120 mm

7084

7084/AB 9	-	7084/BB 9	7084/BC 9	-	2.5	4	100% polyester
-----------	---	-----------	-----------	---	-----	---	----------------

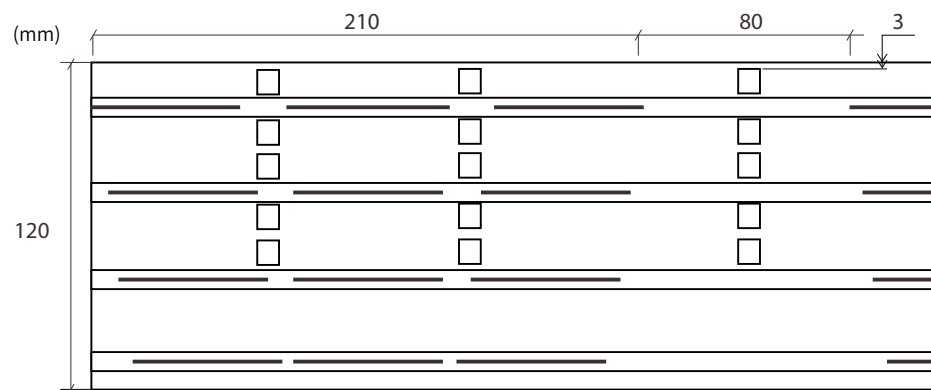

RUBANS

TECHNIQUES

TESCHNISCHE BAENDER

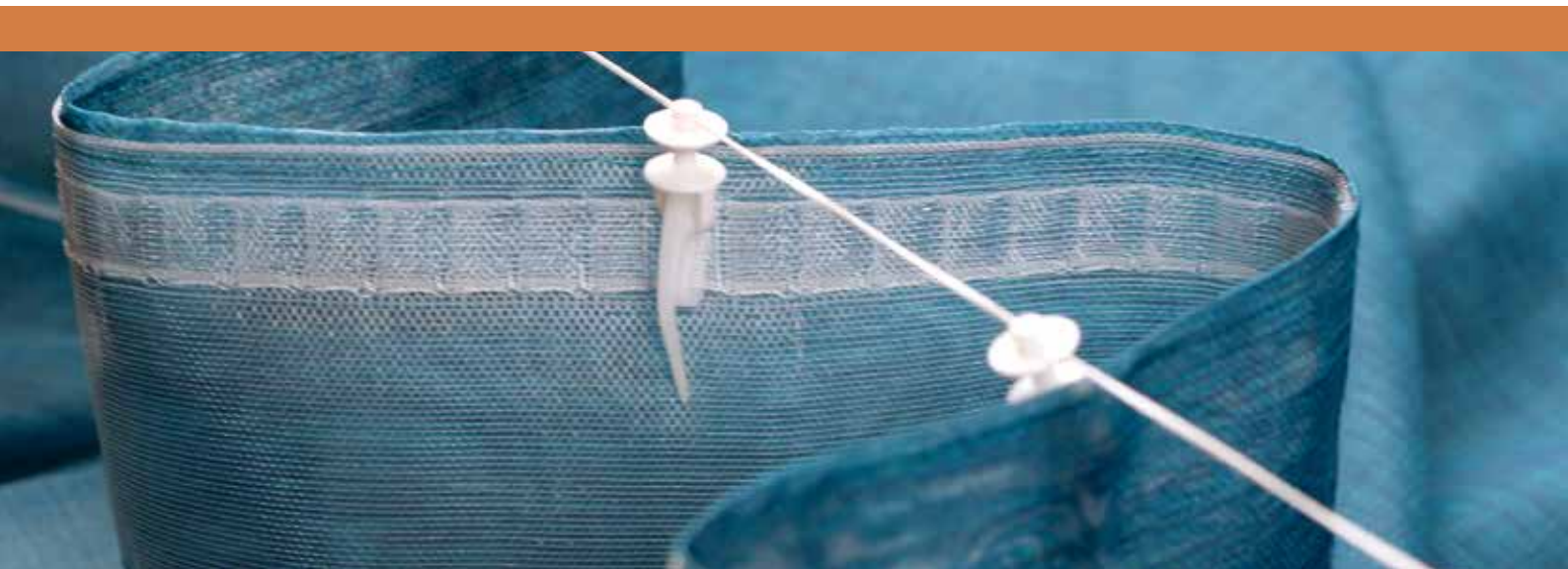

FETTUCCE TECNICHE

TECHNICAL TAPES



PRÉSENTATION

AUFMACHUNG / CONFEZIONE / PACKAGING

 x 50m	Boîte dévidoir x 50 mètres	AB
 x 100m	Boîte dévidoir x 100 mètres	AC
 x 100m	Rouleau filmé x 100 mètres	BC



RÉFÉRENCES COULEURS



Blanc



Sable



Cylindré



Apprêté

LA CARTOUCHIERE

Les rubans cartouchières s'utilisent avec des agrafes métalliques tête haute ou tête basse. Les agrafes à tête basse permettent de cacher complètement la tringle à rideaux. Certaines agrafes permettent de proposer un pli double ou triple, sans cordon de tirage. Retrouver nos agrafes dans la rubrique « Accessoires ».

LES RUBANS A PASSANTS

Rubans René Héraud a été précurseur en proposant le ruban à passants cachés le RPC100 devenu depuis un standard dans la confection de tête pour rideaux. Depuis, cette gamme s'est étoffée avec de nouvelles déclinaisons et continue de séduire par sa facilité d'utilisation.

LE WAVE

Le système Wave ou pli vague, est un ruban transparent utilisé avec un système de galets plastique connecté par un fil qui circule dans un rail. Ce style de confection est particulièrement prisé dans l'hôtellerie ou l'aménagement de bureaux. Ils s'utilisent avec nos rails Unirail ou Decorail, rubrique mécanisme pour store.

LES RENFORTS

Les renforts tissés ou intissés, à coudre ou thermocollant sont à utiliser pour la confection de rideaux à œillet. Les renforts à poches s'utilisent comme un ruban traditionnel : couture à plat ou plis cousus.

RUBANS

TECHNIQUES

CARTOUCHIÈRE

STANGENEINSCHUBBAND / FETTUCCIA CARTUCCIERA / CARTRIDGE TAPE

85 mm

7140



X 50m



X 100m



AMPLITUDE

ZUGABE
AMPIEZZA
ADDITION

CORDON

ZUGSCHNUERE
CORDE
PULL CORD

COMPOSITION

ZUSAMMENSETZUNG
COMPOSIZIONE
COMPOSITION

7140/AB 2

7140/BC 2



1.5 -> 3

-

100% polyester

7140/AB 5

7140/BC 5

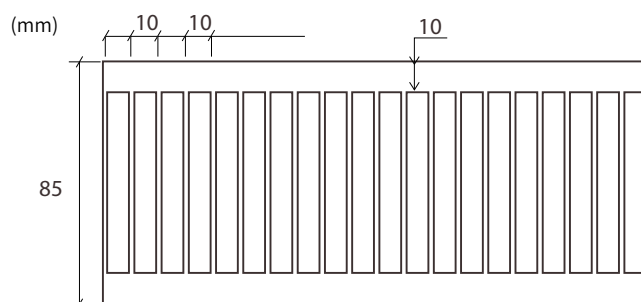

Réf. agrafe 108 120



Réf. agrafe 106 120

PLI AVEC AGRAFES

RÉFÉRENCES

117120	121120
133120	106120
127120	108120



RUBANS

TECHNIQUES

SYSTEME-VAGUE

WELLENBAND KONZEPT / FETTUCCIA ONDA CONCETTO / WAVE TAPE SYSTEM



7120
7153
7062
7155
7151

PROFILS

SCHIENEN / BINARI / RAILS

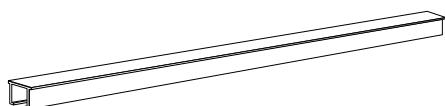

	FINITION ENDBEARBEITUNG RIFINITURA FINITION
KIT AT910 - 9913	Aluminium laqué blanc C9
DECORAIL - KIT 5504	Aluminium laqué blanc C9
	Aluminium gris alu C160

CORDON SCHNUR MIT HAKEN

CORDONE CON GANCI SNAP CARRIERS

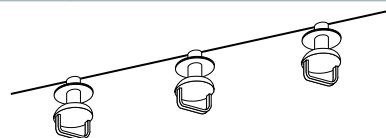

	DIMENSIONS MASSE DIMENSIONI DIMENSION
X 50m / x100m	
K407688-50	8 cm
K407689-50	6 cm
K407687 - 100	7 cm

CROCHETS

HAKEN / GANCI / HOOKS



COMPOSITION
ZUSAMMENSETZUNG
COMPOSIZIONE
COMPOSITION

14250	100 % Nylon
-------	--------------------

Le Surf 360 est un ruban sur lequel sont sertis des glisseurs rotatifs. Ce système Wave s'adapte sur la majorité des tringles rail.



Pour plus d'informations, scannez ce QR code

RUBANS

TECHNIQUES

RUBAN VAGUE

WELLENBAND / FETTUCCIA ONDA / WAVE TAPE

75 mm

7120



X 100m



X 100m

COMPOSITION

ZUSAMMENSETZUNG
COMPOSIZIONE
COMPOSITION

7120/AC 9

7120/BC 9

100% polyester

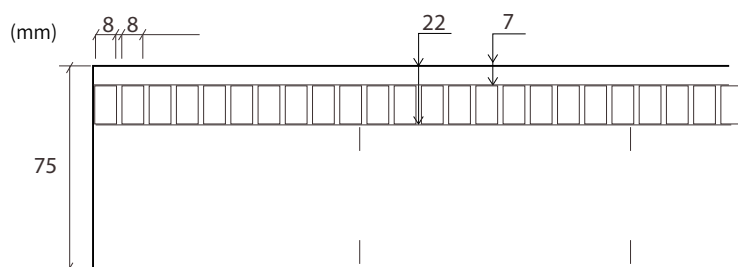

70 mm

7153



X 50m

COMPOSITION

ZUSAMMENSETZUNG
COMPOSIZIONE
COMPOSITION

7153/BB 9

100% polyester

Calcul du métrage du ruban 7120 pour un espacement des crochets de 10 poches pour 1 panneau

Dimension du rail en cm	100	120	140	160	180	200	220	240	260	280	300	320	340	360	380	400
Nb de glisseur - 6cm	18	20	24	28	30	34	38	40	44	48	50	54	58	60	64	68
Métrage en cm	186	206	246	286	306	346	386	406	446	486	506	546	586	606	646	686
Nb de glisseur - 8cm	14	16	18	20	24	26	28	30	34	36	38	40	44	46	48	50
Métrage en cm	148	168	188	208	248	268	288	308	348	368	388	408	448	468	488	508

Calcul du métrage du ruban 7120 pour un espacement des crochets de 10 poches pour 2 panneaux

Dimension du rail en cm	100	120	140	160	180	200	220	240	260	280	300	320	340	360	380	400
Nb de glisseur - 6cm	20	20	24	28	32	36	40	40	44	48	52	56	60	60	64	68
Métrage en cm	212	212	252	292	332	372	412	412	452	492	532	572	612	612	652	692
Nb de glisseur - 8cm	16	16	20	20	24	28	28	32	36	36	40	40	44	48	48	52
Métrage en cm	176	176	216	216	256	296	296	336	376	376	416	416	456	496	496	536

75 mm

7062

7062/AC 9

7062/BC 9

100% polyester

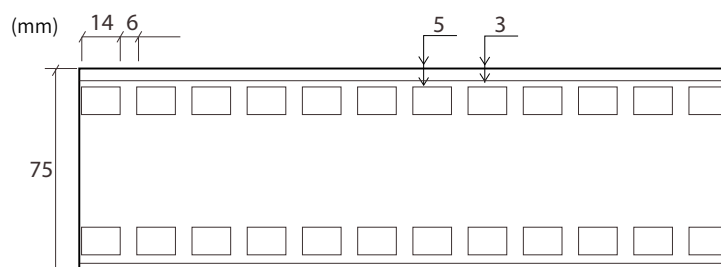

RUBANS

TECHNIQUES

RUBAN VAGUE

WELLENBAND / FETTUCCIA ONDA / WAVE TAPE

75 mm

7155



X 100m



X 100m

COMPOSITION

ZUSAMMENSETZUNG
COMPOSIZIONE
COMPOSITION

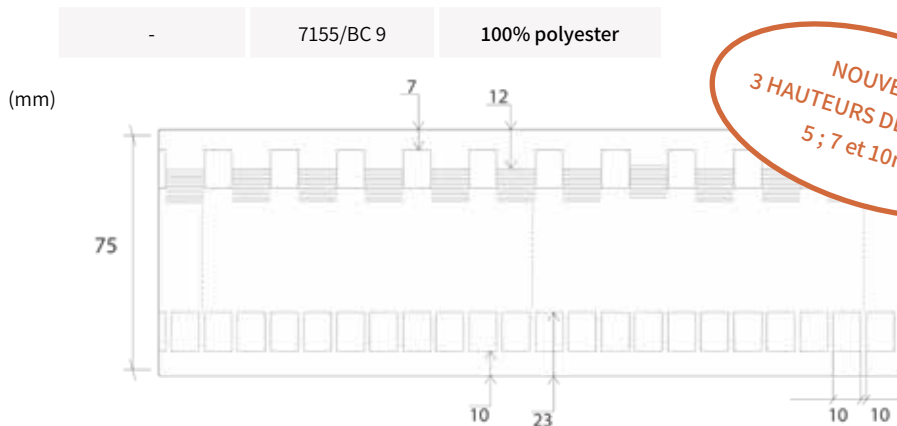

NOUVEAU!
3 HAUTEURS DE POCHE:
5 ; 7 et 10mm

RUBAN VAGUE AUTOMATIQUE

WELLENBAND AUTOMATISCHES / FETTUCCIA ONDA AUTOMATICA / AUTOMATIC WAVE TAPE

100 mm

7151



X 50m



X 100m

COMPOSITION

ZUSAMMENSETZUNG
COMPOSIZIONE
COMPOSITION

AMPLITUDE

ZUGABE
AMPIEZZA
ADDITION

DISTANCE ENTRE PLIS

FALTENABSTAND
DISTANZA TRA LE PIEGHE
DISTANCE BETWEEN PLEATS

7151/BB 9	7151/BC 9	100% polyester	2	6 CM
-----------	-----------	----------------	---	------

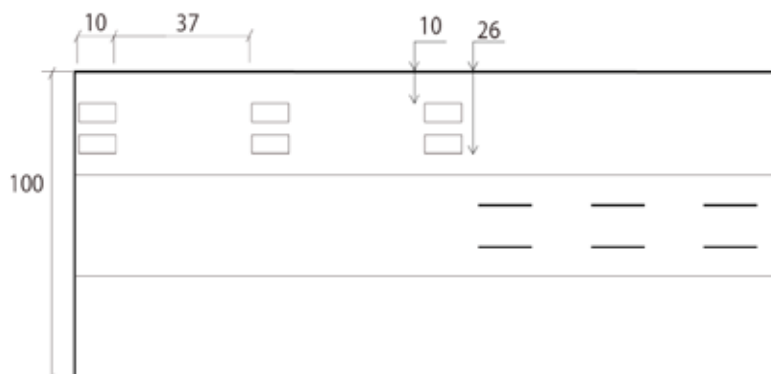

A utiliser sans
cordon onda



Sans rail
Tringle classique

RUBANS

TECHNIQUES

RENFORT POCHES

VERSTAERKUNG MIT TASCHEN / RINFORZO CON TASCHE / POCKETS BUCKRAM



70 mm
7047

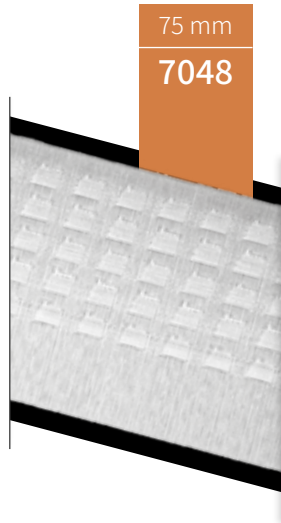

75 mm
7048

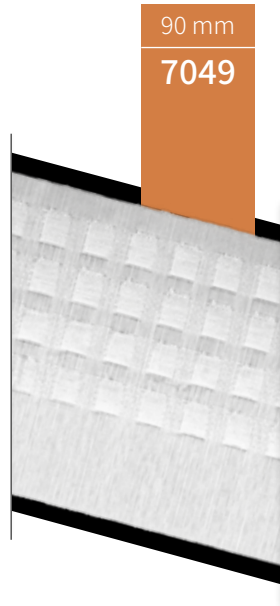

90 mm
7049



120 mm
7050



X 100m

POCHES
TASCHEN
TASCHE
POCKETS

COMPOSITION
ZUSAMMENSETZUNG
COMPOSIZIONE
COMPOSITION

7047/BC 2

4

7048/BC 2

5

7049/BC 2

4

7050/BC 2

6

100%
polyester



70 mm
7106

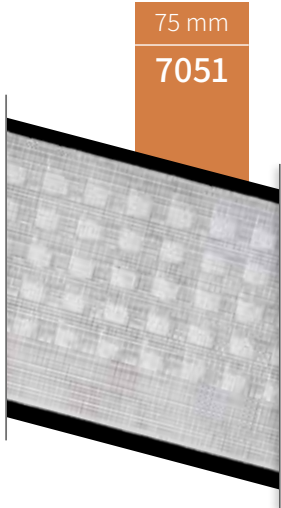

75 mm
7051



90 mm
7052



120 mm
7053



X 100m

POCHES
TASCHEN
TASCHE
POCKETS

COMPOSITION
ZUSAMMENSETZUNG
COMPOSIZIONE
COMPOSITION

7106/BC 9

4

7051/BC 9

5

7052/BC 9

4

7053/BC 9

6

100%
polyester



RUBANS

TECHNIQUES

PASSANT CACHE DECOUPE

STEBBAND / RINFORZO CON PASSANTI PREFORATI / BUCKRAM WITH PREHOLED LOOPS

100 mm

PCD100



X 50m



X 100m



X 100m



AMPLITUDE

ZUGABE
AMPIEZZA
ADDITION

CORDON

ZUGSCHNUERE
CORDE
PULL CORD

COMPOSITION

ZUSAMMENSETZUNG
COMPOSIZIONE
COMPOSITION

PCD100/AB 9

-

PCD100/BC 9



-

-

100 % polyester

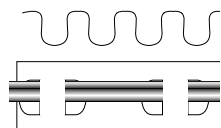
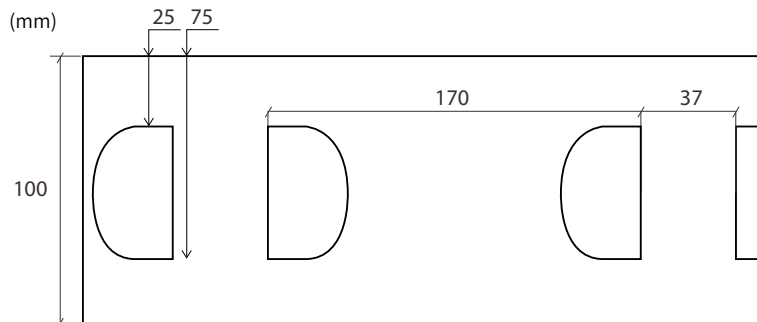

Option 1

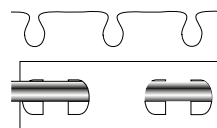

Option 2

RENFORT PREPERCE AUFGESCHNITTE TRANSPARENTE VERSTAERKUNG

RINFORZO PREFORATO TRASPARENTE / PRE HOLED TRANSPARENT BUCKRAM

80 - 100 mm

47100-050



X 50m



X 100m



x50m



COMPOSITION

ZUSAMMENSETZUNG
COMPOSIZIONE
COMPOSITION

47100-050/AB 9

47100-050/BC 9

47100-050/BB 9

50 mm

100% polyester



80 - 100 mm

47080-040

47080-040/AB 9

47080-040/BC 9

40 mm

100% polyester



RUBANS

TECHNIQUES

RENFORTS ET BANDE TISSÉES

STEBBAND / NASTRO CON PASSANTI / TAPE WITH LOOPS

50 mm

RPC050



X 50m



X 100m

COMPOSITION

ZUSAMMENSETZUNG
COMPOSIZIONE
COMPOSITION

RPC050-10/AB 9

RPC050-10/BC 9

100% polyester

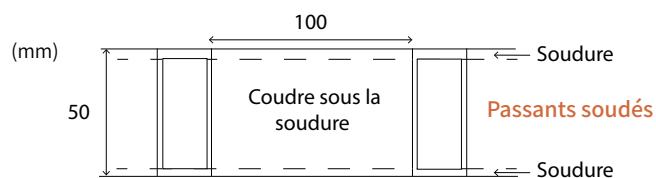

50 mm

RPC47050

RPC47050/AB 9

RPC47050/BC 9

100% polyester

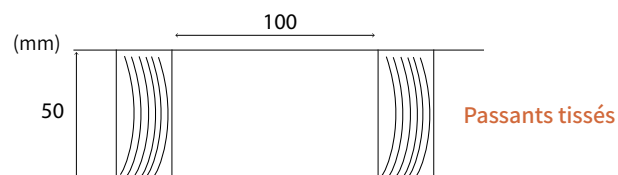

100 mm

RPC100

RPC100/AB 9

RPC100/BC 9

100% polyester

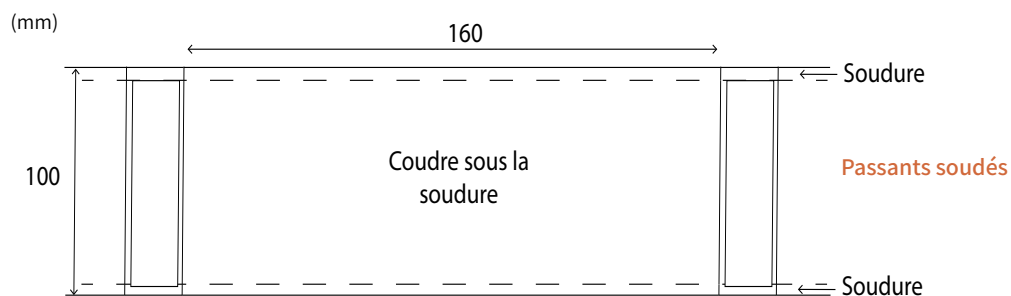

100 mm

RPC47100

RPC47100/AB 9

RPC47100/BC 9

100% polyester

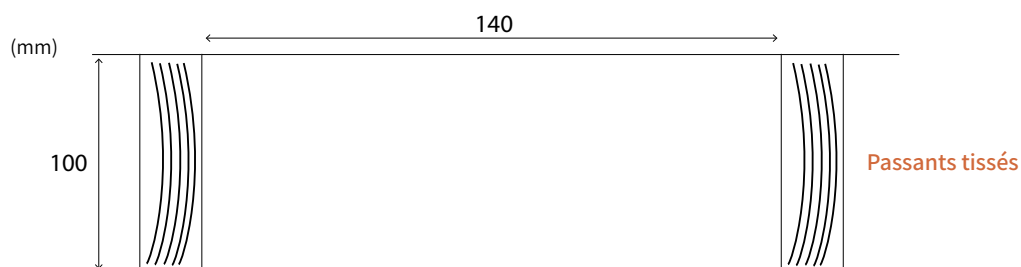

RUBANS

TECHNIQUES

THERMORENFORT THERMOKLEBBENDE VERSTAERKUNG AUS POLYCOTON RINFORZO IN POLYCOTON TERMOADESIVO / HOT-MELT POLYCOTON BUCKRAM



Renforts thermocollants
Facile et Rapide à positionner
à l'aide d'un fer à repasser



X 50m



X 100m

LARGEUR
BREITE
LARGHEZZA
WIDTH

COMPOSITION
ZUSAMMENSETZUNG
COMPOSIZIONE
COMPOSITION

-	49100/BC M3	100 mm	100% polyester
49101/BB 9	-	100 mm	100% polyester



X 50m

LARGEUR
BREITE
LARGHEZZA
WIDTH

COMPOSITION
ZUSAMMENSETZUNG
COMPOSIZIONE
COMPOSITION

43100/BB	100 mm	100% polyester
----------	--------	----------------

RENFORT TISSÉ

VERSTAERKUNG AUS BAUMWOLLE / RINFORZO IN COTTONE / COTTON BUCKRAM



X 100m

LARGEUR
BREITE
LARGHEZZA
WIDTH

COMPOSITION
ZUSAMMENSETZUNG
COMPOSIZIONE
COMPOSITION

40100/BC 9	100 mm	100% polyester
------------	--------	----------------

RUBANS

TECHNIQUES

RENFORT TRANSPARENT

TRANSPARENTE VERSTAERKUNG / RINFORZO TRASPARENTE / TRANSPARENT BUCKRAM

40->135 mm

47...



X 100m

LARGEUR
BREITE
LARGHEZZA
WIDTH

COMPOSITION
ZUSAMMENSETZUNG
COMPOSIZIONE
COMPOSITION

47040/BC 9	40 mm	100% polyester
47050/BC 9	50 mm	
47070/BC 9	70 mm	
47080/BC 9	80 mm	
47090/BC 9	90 mm	
47100/BC 9	100 mm	
47120/BC 9	120 mm	
47135/BC 9	135 mm	

RENFORT TRANSPARENT LISIÈRES RENFORCÉES

TRANSPARENTE VERSTÄRKUNG VERSTÄRKTE KANTEN / RINFORZO TRASPARENTE BORDI RINFORZATI / REINFORCED TRANSPARENT STRENGTHENED EDGE

20->50 mm

47...



X 100m

LARGEUR
BREITE
LARGHEZZA
WIDTH

COMPOSITION
ZUSAMMENSETZUNG
COMPOSIZIONE
COMPOSITION

47020/BC 9	20 mm	100% polyester
47045/BC 9	45 mm	
47050/BC 9	50 mm	

RENFORT INTISSÉ

VERSTAERKUNG AUS BAUMWOLLE / RINFORZO IN COTTONE / COTTON BUCKRAM

48100

44080

44100

44150



X 100m

LARGEUR
BREITE
LARGHEZZA
WIDTH

COMPOSITION
ZUSAMMENSETZUNG
COMPOSIZIONE
COMPOSITION

120 Gr/m²

48100/BC 2	100 mm	100% Polypropylène
145 Gr/m ²		
44080/BC 2	80 mm	
44100/BC 2	100 mm	
44150/BC 2	150 mm	

RUBANS





STORE

RAFFROLLOBAND
NASTRO TUBULARE
ROMAN BLIND TAPE



PRÉSENTATION

AUFMACHUNG / CONFEZIONE / PACKAGING

 x 50m	Boîte dévidoir x 50 mètres	AB
 x 100m	Boîte dévidoir x 100 mètres	AC
 x 100m	Rouleau filmé x 100 mètres	BC
 x 200m	Bobine filmée x 200 mètres	ED



RÉFÉRENCES COULEURS



Ecre

Cylindré

Apprêté

Noir

■ Nous proposons une gamme exhaustive de rubans destinés à la confection de divers types de stores : bouillonnés, américains, bateaux...

Notre gamme se décline en rubans tubulaires, à passants ou anneaux cousus, assortis de cordon de tirage blanc ou en couleur.

RUBANS STORE

CORDON DE TIRAGE

SCHNUERE / CORDINO PER PACCHETTI / CORD

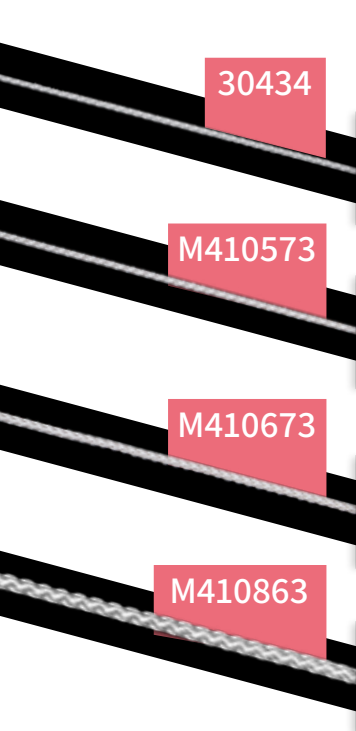



	 X 200m	 X 500m	LARGEUR BREITE LARGHEZZA WIDTH	COMPOSITION ZUSAMMENSETZUNG COMPOSIZIONE COMPOSITION	FINITION ENDBEARBEITUNG RIFINITURA FINITION
30434/ED 0	-	-	1 mm	100% polyester	écru
-	M410573/500	-	1,1 mm	100% polyamide	blanc
-	M410673/500	-	1,5 mm	100% polyamide	blanc*
M410863/200	-	-	3 mm	100% polyamide	blanc

* existe en couleur : beige, gris, marron

GALON POULIE

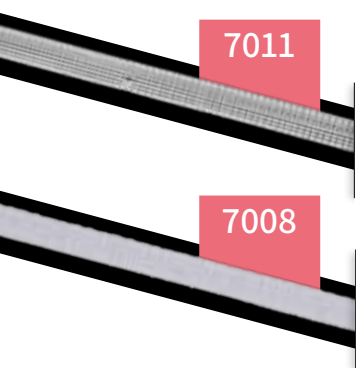
BAND FUER SEILROLLE / NASTRO PER PULEGGE PACCHETTI / TAPE FOR PULLEY



	 X 200m	LARGEUR BREITE LARGHEZZA WIDTH	COMPOSITION ZUSAMMENSETZUNG COMPOSIZIONE COMPOSITION	FINITION ENDBEARBEITUNG RIFINITURA FINITION
7011/ED 3	-	6 mm	100% polyester	cyllindré
7008/ED 3	-	6 mm	100% polyester	cyllindré

TUBULAIRE STORE BATEAU

WEISSES HOHLBAND / NASTRO TUBULARE PER PACCHETTI BIANCO / WHITE ROMAN BLIND TAPE



	 X 200m	LARGEUR BREITE LARGHEZZA WIDTH	COMPOSITION ZUSAMMENSETZUNG COMPOSIZIONE COMPOSITION
7005/ED 3	-	15 mm	100% polyester

RUBANS STORE

TUBULAIRE STORE BATEAU

WEISSES HOHLBAND / NASTRO TUBULARE PER PACCHETTI BIANCO / WHITE ROMAN BLIND TAPE

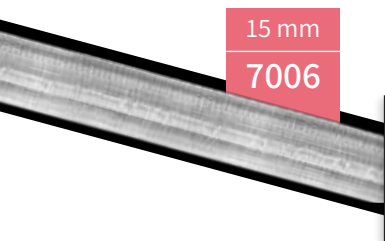

15 mm

7006



X 200m

LARGEUR
BREITE
LARGHEZZA
WIDTH

COMPOSITION
ZUSAMMENSETZUNG
COMPOSIZIONE
COMPOSITION

7006/ED 9

15 mm

100% polyester

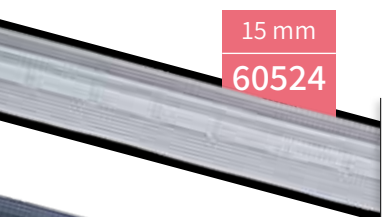

15 mm

60524



noir 7100

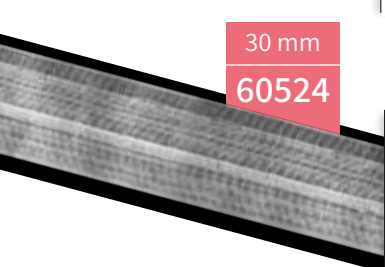

30 mm

60524

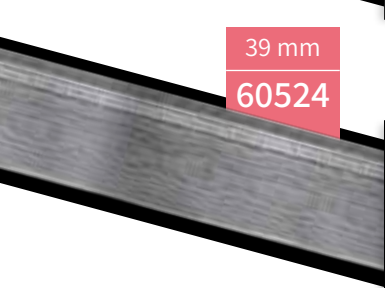

39 mm

60524



X 100m



X 200m

LARGEUR
BREITE
LARGHEZZA
WIDTH

COMPOSITION
ZUSAMMENSETZUNG
COMPOSIZIONE
COMPOSITION

-	60524-15/ED 9	15 mm	100% polyester
60524-15/EB 7100	-	15 mm	
-	60524-30/ED 9	30 mm	
60524-39/BC 9	-	39 mm	

RUBAN STORE BOUILLONNE TRANSPARENT

RAFFROLLOBAND MIT FALTEN
NASTRO CON PASSANTI PER PACCHETTI CON PIEGHE / ROMAN BLIND PLEATED TAPE

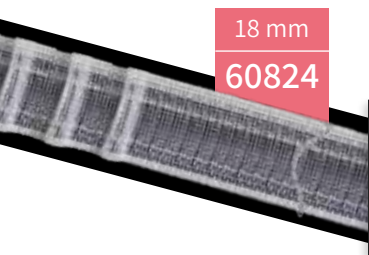

18 mm

60824



X 200m

LARGEUR
BREITE
LARGHEZZA
WIDTH

COMPOSITION
ZUSAMMENSETZUNG
COMPOSIZIONE
COMPOSITION

60824-18/ED 9

18 mm

100% polyester

* à rupture de stock

RUBANS STORE

RUBAN STORE A POCHEs RAFFROLLOBAND MIT TASCHEN NASTRO CON TASCHE PER PACCHETTI / ROMAN BLIND TAPE WITH POCKETS

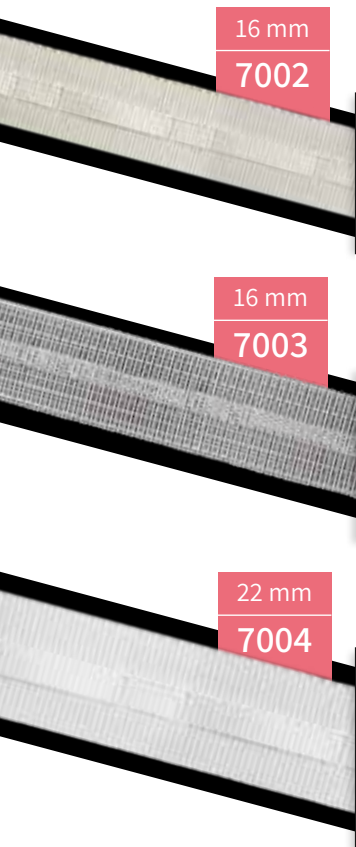

X 200m

LARGEUR
BREITE
LARGHEZZA
WIDTH

COMPOSITION
ZUSAMMENSETZUNG
COMPOSIZIONE
COMPOSITION

7002/ED 3

16 mm

100% polyester

16 mm

7003

7003/ED 9

16 mm

100% Polyester

22 mm

7004

7004/ED 3

22 mm

100% polyester

RUBAN STORE A PASSANTS TRANSPARENT RAFFROLLOBAND MIT TRANSPARENTEN SCHLAUFEN / NASTRO CON PASSANTI PER PACCHETTI ROMAN BLIND TAPE WITH TRANSPARENT LOOPS

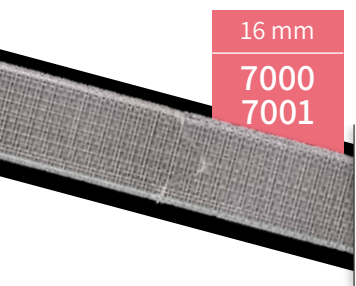

X 200m

LARGEUR
BREITE
LARGHEZZA
WIDTH

COMPOSITION
ZUSAMMENSETZUNG
COMPOSIZIONE
COMPOSITION

7000/ED 9

16 mm
Espace entre 2 boucles : 15 cm

100% polyester

7001/ED 9

16 mm
Espace entre 2 boucles : 5 cm

RUBAN STORE A ANNEAUX TRANSPARENT TRANSPARENTES RINGBAND NASTRO CON ANELLINI PER PACCHETTI / TRANSPARENT ROMAN BLIND TAPE WITH RINGS

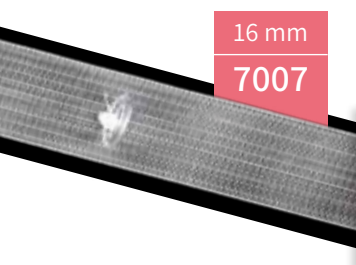

X 150m

LARGEUR
BREITE
LARGHEZZA
WIDTH

COMPOSITION
ZUSAMMENSETZUNG
COMPOSIZIONE
COMPOSITION

7007/EC 9

16 mm
Espacement entre 2 anneaux : 15 cm

100% polyester

ACCESSOIRES

ZUBEHÖR FÜR GARDINEN
ACCESSORI PER TENDE
ACCESSORIES FOR CURTAINS



■ Notre politique est de pouvoir fournir un large éventail d'articles dédiés aux métiers de l'ameublement. Pour cela, nous proposons une sélection de produits venant compléter notre offre de ruban 100 % Made in Auvergne avec :

- L'une des plus larges collections d'œillets métalliques et plastiques, avec un choix de diamètre de 12 à 66 mm ;
- Des presses manuelles ou pneumatiques pour sertir les œillets en acier ou laiton ;
- Une large gamme d'agrafes en plastique et métal pour suspendre les rideaux sur une tringle ou un rail ;
- Des rubans auto-agrippant utilisés pour la mercerie, la confection de store ou toute autre application industrielle ;
- Du plomb lesteur pour les voilages, ainsi que des poids de charge ;
- Des ourlets thermocollants.

ACCESSOIRES

PLOMB - ZINC

BLEI / PIOMBO - ZINK / ZINCO



PLOMB LESTEUR

EN BARRETTE	13g	151013/050 0	x 50 p
	25g	151025/025 0	x 25 p
	50g	151050/025 0	x 25 p
AU MÈTRE	15g	150015/EB 0	x 100 m
	25g	150025/EB 0	x 100 m
	35g	150035/EA 0	x 50 m
	50g	150050/EA 0	x 50 m
	70g	150070/EA 0	x 50 m
	100g	150100/EA 0	x 50 m
	200g	150200/EN 0	x 25 m
	400g	150400/AB 0	x 50 m
ZINC AU MÈTRE	25g	160025/AD 0	Boîte x 1000 m



RAPID'OURLET

EINFACHER SAUM / FACILE ORLO



VOILE THERMOCOLLANT

100% polyamide	4530/BC 0	100 m x 30 mm	rouleaux x 100 m
	4530/FV 0	5 m x 30 mm	Cartonnette x 1 pièce vendu par lot de 6



GRILLE THERMOCOLLANTE

100% polyamide	4531/FV 0	3 m x 40 mm	Cartonnette x 1 pièce vendu par lot de 6
----------------	-----------	-------------	--

ACCESSOIRES



145550

145500

147550

147500

143550

143500



14250



14250



141110



141111



141120



141140



134110



144504



134120



117120



133120



144502



144505



127120



121120



106120



108120

AGRAFES VRAC HEFTKLAMMERN AUSEINANDER GANCI ALLA RINFUSA / LOOSE HOOKS

PLASTIQUE

14250/FJ	escargot nylon (blanc 0 / noir C180)	x 25000
14250/FF	escargot nylon	
143500/FF	épingle cristal GM*	
143550/FF	épingle cristal PM**	
145500/FF	à coudre cristal GM*	
145550/FF	à coudre cristal PM**	x 1000
147500/FF	1 branche cristal GM*	
147550/FF	1 branche cristal PM**	
144504/FF	agrafe réglable à coudre 75 mm	
144505/FF	agrafe réglable à coudre 95 mm	
144504/FH	agrafe réglable à coudre 75 mm	x 5000
144505/FH	agrafe réglable à coudre 95 mm	

ACIER

141110/FF	escargot acier	x 1000
141111/FF	escargot acier recourbé	
141120/FE	couturière 21 mm	x 500
141140/FE	acier 2 branches	
133120/FC	1 branche 30 mm de tête	
117120/FC	1 branche sans tête	
121120/FC	2 branches 30 mm de tête	x100
127120/FC	2 branches sans tête	
108120/FC	4 branches 30 mm de tête	
106120/FC	4 branches sans tête	
134110/FE	agrafe aiguille tête ordinaire	x 500
134120/FAG	agrafe aiguille tête flamande	x 400

AGRAFES BLISTER HEFTKLAMMERN IN BLISTER VERPACKT GANCI IN BLISTER / HOOKS IN BLISTER

vendu par lot de 6

106120/FN	4 branches sans tête	
108120/FN	4 branches 30 mm de tête	
117120/FN	1 branche sans tête	x 10
133120/FN	1 branche 30 mm de tête	
127120/FN	2 branches sans tête	
121120/FN	2 branches 30 mm de tête	
141110/FN	escargot acier	
141111/FN	escargot acier recourbé	
141120/FN	couturière 21 mm	
141140/FN	acier 2 branches	
14250/FN	escargot nylon	
143500/FN	épingle cristal GM*	x 20
143550/FN	épingle cristal PM**	
144502/FN	agrafe universelle	
145500/FN	à coudre cristal GM*	
145550/FN	à coudre cristal PM**	
147500/FN	1 branche cristal GM	
147550/FN	1 branche cristal PM**	

* GM : Ø 28 / 35 ** PM : Ø 20 / 28

ACCESSOIRES

RUBAN AUTO AGRIPPANT

FLAUSCHBAND UND KLETTENBAND / VELCRO / SELF GRIPPING HOOK AND LOOP TAPE

Flasque
x 25 mètres



COULEURS :



* Arrêt jusqu'à rupture

Flasque x 25 m BA	B : blanc N : noir	AC : à coudre ADH : adhésif	16 mm	20 mm	25 mm	30 mm	50 mm	100 mm
Velours	B	AC	816V/ BA B	820V/BA B	825V/BA B	830V/BA B	850V/BA B	8100V/BA B
Crochet	B	AC	816C/ BA B	820C/BA B	825C/BA B	830C/BA B	850C/BA B	8100C/BA B
Velours	N	AC	816V/BA N	820V/BA N	825V/BA N	830V/BA N	850V/BA N	8100V/BA N
Crochet	N	AC	816C/BA N	820C/BA N	825C/BA N	830C/BA N	850C/BA N	8100C/BA N
Velours	B	ADH	816VADH/BA B	820VADH/BA B	825VADH/BA B	830VADH/BA B	850VADH/BA B	8100VADH/BA B
Crochet	B	ADH	816CADH/BA B	820CADH/BA B	825CADH/BA B	830CADH/BA B	850CADH/BA B	8100CADH/BA B
Velours	N	ADH	816VADH/BA N	820VADH/BA N	825VADH/BA N	830VADH/BA N	850VADH/BA N	8100VADH/BA N
Crochet	N	ADH	816CADH/BA N	820CADH/BA N	825CADH/BA N	830CADH/BA N	850CADH/BA N	8100CADH/BA N

Composition : 60% Polyester
40% Polyamide

ACCESSOIRES

ŒILLET POUR RIDEAUX

VORHANGÖSEN / OCCHIELLI PER TENDE / EYELETS FOR CURTAINS

GAMME LAITON



148500
laiton



148502
canon de fusil



148504
vieux cuivre

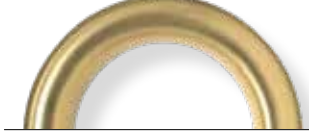

148506
laiton mat



148501
nickel brillant



148503
nickel mat



148505
vieux bronze



148508
vieux nickel

GAMME LAQUÉE - Ø40

148510



C12
blanc



C15
crème



C220
champagne



C19
noir brillant



C20
anthracite black



181502
canon de fusil



181509
noir mat



181503
nickel mat

GAMME INOX



180200
Ø40



180100
Ø25

GLISSE ŒILLET TRANSLUCIDE



Ø 40	144600/FN 0	Blister x 16 pièces Vendu par lot de 6
	144600/FF 0	Sachet x 1000 pièces

ACCESSOIRES

ŒILLET POUR RIDEAUX

VORHÄNGÖSEN / OCCHIELLI PER TENDE / EYELETS FOR CURTAINS

LAITON ROND



	Ø 12		Ø 15		Ø 25		Ø 30		Ø 40		Ø 50		Ø 66	
	x 500 P	x 500 P	x 500 P	x 100 P	x 500 P	x 100 P	x 500 P	x 100 P	x 500 P	x 100 P	x 500 P	x 100 P	x 500 P	x 100 P
laiton	-	148560/FE	148550/FE	148550/FC	177400/FE	177400/FC	148500/FE	148500/FC	177200/FE	177200/FC*	177300/FE	177300/FC*		
nickel brillant	-	148561/FE	148551/FE	148551/FC	177401/FE	177401/FC	148501/FE	148501/FC	177201/FE	177201/FC*	177301/FE	177301/FC*		
canon de fusil	177602/FE	148562/FE	148552/FE	148552/FC	177402/FE	177402/FC	148502/FE	148502/FC	177202/FE	177202/FC*	177302/FE	177302/FC*		
nickel mat	177603/FE	148563/FE	148553/FE	148553/FC	177403/FE	177403/FC	148503/FE	148503/FC	177203/FE	177203/FC*	177303/FE	177303/FC*		
vieux cuivre	-	-	148554/FE	148554/FC	177404/FE	177404/FC	148504/FE	148504/FC	177204/FE	177204/FC*	177304/FE	177304/FC*		
vieux bronze	-	-	148555/FE	148555/FC	177405/FE	177405/FC	148505/FE	148505/FC	177205/FE	177205/FC*	177305/FE	177305/FC*		
laiton mat	177606/FE	-	148556/FE	148556/FC	177406/FE	177406/FC	148506/FE	148506/FC	177206/FE	177206/FC*	177306/FE	177306/FC*		
vieux nickel	-	-	148558/FE	148558/FC	177408/FE	177408/FC	148508/FE	148508/FC	-	-	-	-		
noir mat	-	-	148559/FE	148559/FC	-	-	181509/FE	181509/FC	-	-	-	-		

* Sur commande

LAITON CARRÉ



Ø 40

	x 500 P	x 100 P
laiton	148570/FE	148570/FC
nickel brillant	148571/FE	148571/FC
canon de fusil	148572/FE	148572/FC
nickel mat	148573/FE	148573/FC
vieux cuivre	148574/FE	148574/FC
vieux bronze	148575/FE	148575/FC
laiton mat	148576/FE	148576/FC

LAQUÉ ROND



Ø 40

	x 500 P	x 50 P
blanc	148510/FE	148510/FB
crème	C12	
noir brillant	C15	
champagne	C19	
	C220	

ACIER ROND



Ø 40

	x 500 P
laiton	178100/FE
nickel brillant	178101/FE
canon de fusil	178102/FE
nickel mat	178103/FE
vieux cuivre	178104/FE
vieux bronze	178105/FE
laiton mat	178106/FE

ACIER PEINT



x 1000 P

canon de fusil	181502/FF
nickel mat	181503/FF
chrome	181506/FF
noir mat	181509/FF

INOX



x 1000 P

inox Ø40	180200/FF
inox Ø25	180100/FF

ACCESSOIRES

PRESSE À ŒILLETS

ÖSENPRESSE / PRESSA PER OCCHIELLI / EYELETS FOR CURTAINS

PRESSE MANUELLE MP 14 - F

Réf. : 148728	Presse MP 14 + outil Ø 40 + guide (Remplace la 148711 M12)
Réf. : 148729	Presse MP 14
Réf. : 148730	Guide MP 14
Réf. : 148712	Outil PM Ø 25
Réf. : 148713	Outil matrice carrée Ø 40
Réf. : 148714	Outil PM Ø 40
Réf. : 148718	Outil PM Ø 50
Réf. : 148715	Outil découpe Ø 47

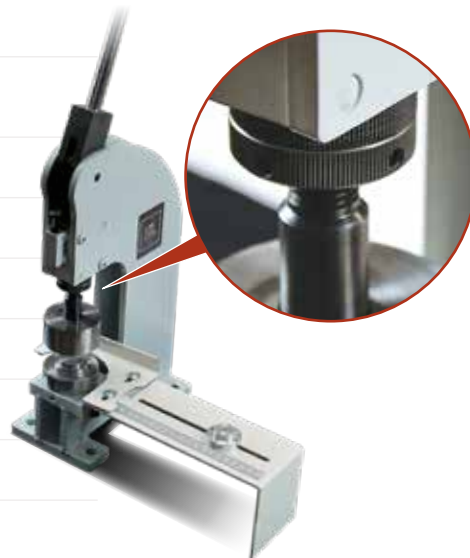

PRESSE MANUELLE MP 22 - G

Réf. : 148914	Presse manuelle MP 22-G 2 en 1 + outil Ø 40 + guide
Réf. : 148909	Presse manuelle MP 22 - G
Réf. : 148901	Outil Ø 40
Réf. : 148904	Guide
Réf. : 148902	Outil Ø 25
Réf. : 148903	Outil matrice carrée
Réf. : 148907	Outil découpe Ø 47
Réf. : 148908	Outil découpe Ø 50
Réf. : 148906	Outil découpe Ø 66

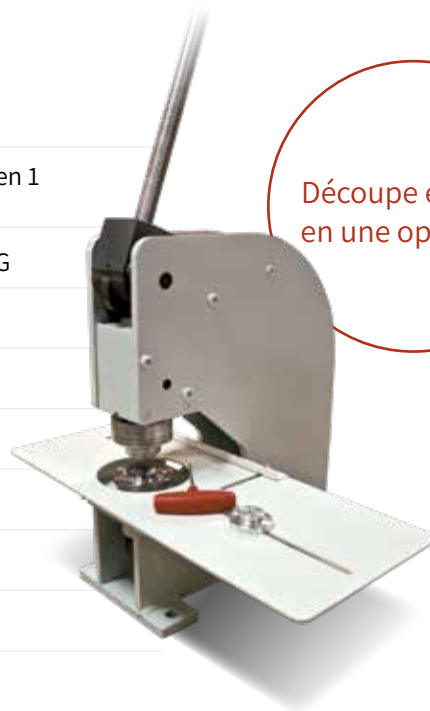

Découpe et sertit
en une opération

PRESSE PNEUMATIQUE MP22-NG

Réf. : 148951	Presse pneumatique MP22-NG
---------------	----------------------------



CONDITIONS GÉNÉRALES DE VENTE

GENERALITES – ACCEPTATION DE COMMANDE

Le fait de passer commande implique l'adhésion entière et sans réserve de l'acheteur à ces conditions générales de vente.

Les commandes sont réputées acceptées à défaut de rejet dans un délai de 15 jours à compter de leur réception.

Toute commande passée par l'acheteur engage et lie celui-ci dès sa passation. Il ne peut intervenir de la part de l'acheteur aucune annulation totale ou partielle ou modification quelconque de commande, sans l'accord exprès et écrit du vendeur.

Lorsque des autorisations ou formalités de toute nature, notamment d'importation ou de change, sont exigées pour l'importation dans le pays de destination ou pour le paiement de nos produits, leur obtention ou accomplissement en temps utile est à la charge et sous l'entière responsabilité de l'acheteur.

DELAIS – CAS FORTUITS – FORCE MAJEURE

Les délais d'exécution des commandes sont ceux en usage dans la profession, sauf délai particulier convenu et accepté dans la commande. Sauf mention particulière, les délais de livraison ne sont donnés qu'à titre indicatif et commencent à courir du jour ouvrable qui suit la réception de tous les documents nécessaires à la réalisation de la commande. Le vendeur est dégagé de plein droit de tout engagement de délai relatif à ses livraisons et se réserve expressément le droit de suspendre toute livraison :

- dans le cas où les conditions de paiement convenues n'auraient pas été observées par le client
- dans le cas où les renseignements techniques ou commerciaux à fournir ou à renvoyer par le client ne seraient pas reçus en temps voulu par le vendeur
- en cas de force majeure ou d'événements tels que : conflits sociaux, épidémies, guerre, réquisition, incendie, inondation, accidents d'outillage
- interruption ou retard dans les transports, ou tout événement identique chez les fournisseurs du vendeur

Les retards ne peuvent en aucun cas justifier l'application de pénalités de retard, ou d'une indemnité quelconque.

TRANSPORT - LIVRAISON

Dans la limite des francs éventuellement stipulés à la commande confirmée (voir incoterm en vigueur), le port est payable par l'acheteur : port dû quand l'acheteur s'occupe du transport ; port payé quand le transport est assuré par nos soins à la demande de nos clients et facturé en sus.

Que le transport soit ou non assuré par nos soins, quel que soit le mode de transport, et nonobstant la clause de réserve de propriété stipulée aux présentes conditions, les marchandises sont délivrées et agréées départ usine et voyagent aux risques et périls de l'acheteur qui doit exercer son recours contre le transporteur en cas de retard, manquant, perte ou avarie.

RECLAMATION

Le destinataire est tenu de vérifier l'état de la marchandise à la réception, et les réserves doivent être apposées sur le bon de livraison contresigné par le transporteur ou son préposé. Ces réserves doivent être confirmées au transporteur par lettre recommandée dans les 3 jours qui suivent celui de la réception (jours fériés inclus) – Article 105 du Code de Commerce. Au cas où ses formalités n'auraient pas été accomplies, l'acheteur ne peut prétendre à aucun dédommagement même partiel de la part du vendeur.

Aucun retour de marchandise ne sera accepté sans notre accord.

Si la réclamation s'avère justifiée, elle fera l'objet d'un échange ou, en cas d'impossibilité d'un avoir. La responsabilité de notre société pour toutes les conséquences de la présente vente est limitée à la valeur facturée du produit vendu.

QUANTITE - TOLERANCE

Les factures sont établies sur la base des quantités réellement fournies. Une tolérance de livraison est fixée à plus ou moins 10% des quantités commandées.

PRIX ET TARIFS

Notre prix et tarifs sont toujours modifiables sans préavis.

La remise de prix, tarifs et conditions, ne constitue pas un engagement de notre part. Les prix sont valables à la date d'établissement de la commande. En cas de hausse de tarif, le client pourra, dans les 3 jours de la notification du nouveau prix, résilier la commande sans indemnité. Passé ce délai la commande sera définitive au nouveau tarif.

Les remises éventuelles sur nos prix ne sont valables que pour la commande à laquelle elles s'appliquent et ne peuvent être reconduites tacitement.

PAIEMENTS – DEFAUTS DE PAIEMENTS

Les factures sont payables au siège du vendeur. Chaque paiement doit être effectué dans la même devise que celle de la facture.

Toute première commande est payable par avance, selon facture proforma, par virement bancaire. Les conditions de paiements accordées par la suite sont déterminées par la réponse de notre assurance crédit de recouvrement. Si la situation financière notoire de l'acheteur suscitait des inquiétudes justifiées, le vendeur se réserve le droit, pour les commandes en cours, de reconsidérer les conditions de paiement consenties, en exigeant la constitution de sûretés ou un paiement comptant.

Toute convention dérogatoire est révoquée à notre gré.

Sous réserve d'une mise en demeure, tout retard de paiement à la date indiquée entraîne de plein droit la faculté pour le vendeur d'exiger des intérêts de retard, à compter de l'échéance.

L'acheteur ne peut pas compenser les sommes dues par celles que nous lui devons.

Dans le cas de clients en situation de redressement judiciaire, toute livraison sera sujette à un règlement par avance sur proforma, par virement bancaire uniquement.

RESERVE DE PROPRIETE

La société HERAUD restera propriétaire des marchandises vendues jusqu'à l'encaissement complet du montant facturé. Les risques sont cependant à la charge de l'acquéreur dès la délivrance des marchandises.

L'acheteur s'interdit d'enlever les emballages ou étiquettes apparaissant sur les marchandises existant physiquement dans ses stocks et non encore réglées.

En cas de saisie par un tiers, l'acheteur est tenu d'en avertir le vendeur immédiatement.

Le défaut de paiement d'une seule échéance, en cas de paiement échelonné, ou d'une seule commande, en cas de ventes successives, emporte exigibilité de la totalité du prix des marchandises encore non réglées, et la possibilité pour le vendeur de suspendre les ordres en cours.

La restitution des marchandises impayées sera due par l'acheteur défaillant à ses frais et risques, sur mise en demeure du vendeur par lettre recommandée avec accusé de réception.

LITIGES – JURIDICTION

En cas de contestation quelconque de tout ou partie des présentes conditions de vente, comme en cas de litige quelconque relatif à toute commande ou à toute vente, les tribunaux du siège social du vendeur seront seuls compétents.

GB – ORDERS AND DELIVERIES ARE SUBMITTED TO THE GENERAL CONDITIONS OF SALE OF COMPANY HERAUD RUBANS

D – AUFTRÄGE UND LIEFERUNGEN UNTERLIEGEN DIE ALLGEMEINEN VERKAUFSBEDINGUNGEN DER FIRMA HERAUD RUBANS

I – GLI ORDINI E LE CONSEGNE SONO REALIZZATI CONFORMEMENTE ALLE CONDIZIONI GENERALI DI VENDITA DELLA SOCIETÀ HERAUD RUBANS

E – LOS PEDIDOS Y EXPEDICIONES SE REALIZAN CONFORME A LAS CONDICIONES GENERALES DE VENTA DE HERAUD RUBANS

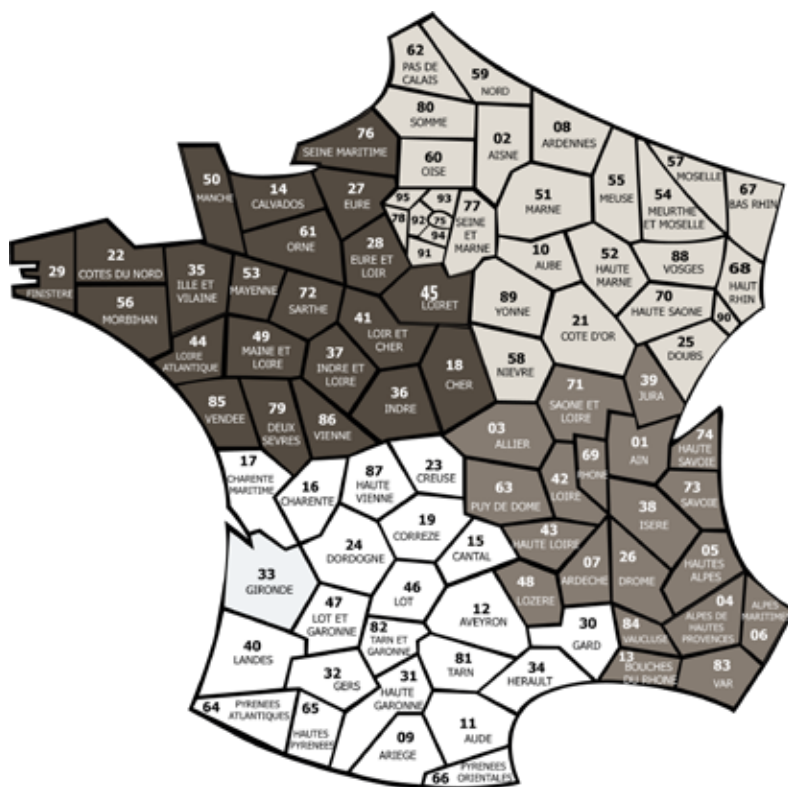

CONTACTS

Direction commerciale		(+33)6 64 95 90 30	dce@rubans-heraud.com
Equipe commerciale France	Secteur Nord Ouest	06 43 01 57 52	sboussin@rubans-heraud.com
	Secteur Sud Ouest	06 33 14 02 74	zonecom2@rubans-heraud.com
	Secteur Nord Est	06 44 83 38 42	bbahuchet@rubans-heraud.com
	Secteur Sud Est	06 77 46 74 16	zonecom1@rubans-heraud.com
Service commercial France	Fabienne NIERHAUVE	04 71 61 75 09	commercial@rubans-heraud.com
	Amandine ROCHEDIX	04 71 61 75 08	commercial1@rubans-heraud.com
Service commercial export	Béatrice VOLO	(+33)4 71 61 75 04	bvol@rubans-heraud.com

RENÉ HÉRAUD

RUBANS & ACCESSOIRES
POUR L'AMEUBLEMENT



ZI Desforanges
Les Portes du Velay
43140 La Séauve-sur-Semène

CONTACT

mail : info@rubans-heraud.com
tel: +33 (0)4 71 61 75 00

Retrouver l'ensemble de nos collections sur nos catalogues & notre site internet:



Accessoires de décoration



Stores sur mesure



www.rubans-heraud.com